

NI 43-101 Technical Report Feasibility Study Revenue–Virginus Mine Ouray, Colorado

Effective Date: December 31, 2021
Report Date: March 11, 2022

Report Prepared for



Ouray Silver Mines, Inc.
PO Box 564
1900 Main Street, Unit 1
Ouray, CO 81427



Aurcana Silver Corporation
Suite 850, 789 West Pender Street
Vancouver BC, Canada
V6C 1H2

Report Prepared by



SRK Consulting (U.S.), Inc.
1125 Seventeenth Street, Suite 600
Denver, CO 80202

SRK Project Number: 561900.020

Signed by Qualified Persons:

Ben Parsons, MSc, MAusIMM (CP), Principal Consultant (Resource Geologist)
Eric J. Olin, MSc Metallurgy, MBA, SME-RM, MAusIMM, Principal Consultant (Metallurgy)
John Tinucci, PhD, PE, Principal Consultant (Geotechnical Engineer)
Jeff Osborn, BEng Mining, MMSAQP, Principal Consultant (Mining Engineer)
Brian Prosser, PE, Principal Consultant (Ventilation)
Joanna Poeck, BEng Mining, SME-RM, MMSAQP, Principal Consultant (Mining Engineer)
Terry Braun, MSc, PE, Practice Leader/Principal Consultant (Civil Engineer)

Reviewed by:

Kevin Gunesch, PE, Principal Consultant (Mining Engineer)
Anton Chan, BEng Mining, MS Earth Science, Peng, MMSAQP, Senior Consultant (Mining Engineer)
Doug Reid, Peng, Principal Consultant (Resource Geology)

Table of Contents

1	Summary	1
1.1	Property Description and Ownership	1
1.2	Geology and Mineralization	1
1.3	Status of Exploration, Development and Operations	2
1.4	Mineral Processing and Metallurgical Testing	2
1.5	Mineral Resource Estimate	4
1.6	Mineral Reserve Estimate	7
1.7	Mining Methods	9
1.8	Recovery Methods	10
1.9	Project Infrastructure	11
1.9.1	Off-Site Infrastructure and Product Logistics	11
1.9.2	On-Site Infrastructure	11
1.10	Environmental Studies and Permitting	14
1.11	Capital and Operating Costs	15
1.12	Economic Analysis	16
1.13	Project Implementation	17
1.14	Conclusions and Recommendations	18
1.14.1	Property Description and Ownership	18
1.14.2	Geology and Mineralization	18
1.14.3	Status of Exploration, Development and Operations	18
1.14.4	Mineral Resource Estimate	19
1.14.5	Recovery Methods	20
1.14.6	Project Infrastructure	20
2	Introduction	21
2.1	Terms of Reference and Purpose of the Report	21
2.2	Qualifications of Consultants	21
2.3	Details of Inspection	22
2.4	Sources of Information	22
2.5	Effective Date	23
2.6	Units of Measure	23
3	Reliance on Other Experts	24
4	Property Description and Location	25
4.1	Property Location	25
4.2	Mineral Titles	26
4.2.1	Nature and Extent of Issuer’s Interest	31

4.2.2	Claim Location and Access	32
4.3	Royalties	32
4.4	Environmental Liabilities and Permitting	32
4.4.1	Environmental Liabilities.....	32
4.4.2	Required Permits and Status	33
5	Accessibility, Climate, Local Resources, Infrastructure and Physiography	34
5.1	Topography, Elevation and Vegetation.....	34
5.2	Accessibility and Transportation to the Property	34
5.3	Climate	34
5.4	Sufficiency of Surface Rights	35
5.5	Infrastructure Availability and Sources.....	35
6	History.....	37
6.1	Prior Ownership and Ownership Changes	37
6.2	Exploration and Development Results of Previous Owners	42
6.3	Historic Production	42
7	Geological Setting and Mineralization	43
7.1	Regional Geology.....	43
7.2	Local Geology	44
7.3	Project Geology.....	45
7.4	Significant Mineralized Zones	50
8	Deposit Type	55
8.1	Mineral Deposit	55
9	Exploration	56
9.1	Relevant Exploration Work	56
9.2	Sampling Methods and Sample Quality.....	56
9.2.1	2011 - 2013 Star Mines	58
9.2.2	FRSM and OSMI Exploration.....	59
9.2.3	Production Sampling	60
9.3	Significant Results and Interpretation	61
10	Drilling.....	63
10.1	Type and Extent.....	63
10.2	Procedures.....	69
10.2.1	Historic.....	69
10.2.2	Star Mines	70
10.2.3	OSMI	71
10.3	Interpretation and Relevant Results.....	73
11	Sample Preparation, Analysis and Security	75

11.1 Security Measures	75
11.1.1 Historical.....	75
11.1.2 OSMI	75
11.2 Sample Preparation for Analysis.....	75
11.2.1 Historical.....	75
11.2.2 OSMI	77
11.3 Sample Analysis.....	77
11.3.1 Historical.....	77
11.3.2 OSMI	79
11.4 Quality Assurance/Quality Control Procedures	80
11.4.1 Standards	80
11.4.2 Blanks.....	82
11.4.3 Duplicates.....	82
11.5 Opinion on Adequacy.....	83
12 Data Verification.....	85
12.1 Validation Process	85
12.2 OSMI Short term Models	87
12.3 Limitations	88
12.4 Opinion on Data Adequacy.....	88
13 Metallurgy.....	90
13.1 Introduction	90
13.2 Prefeasibility Metallurgical Program.....	90
13.2.1 Test Sample Characterization.....	90
13.2.2 Mineralogical Analyses.....	91
13.2.3 Comminution Studies	92
13.2.4 Metallurgical Testwork – Master Composite	93
13.2.5 Metallurgical Testwork: Variability Composites.....	102
13.2.6 Thickening and Filtration Studies	107
13.3 Feasibility Metallurgical Studies.....	109
13.3.1 Test Sample Characterization.....	110
13.3.2 Mineralogical Analyses.....	112
13.3.3 Comminution	114
13.3.4 Confirmatory Flotation Studies.....	114
13.3.5 Large Batch Flotation Studies	116
13.3.6 Locked-Cycle Test on Master Composite	119
13.3.7 Thickening and Filtration Studies	120
13.3.8 Concentrate and Tailing Characterization.....	122

13.4 Recoverability and Relevant Test Results	125
13.5 Process Design Parameters	130
13.6 Significant Factors.....	132
14 Mineral Resource Estimate	134
14.1 Database	134
14.1.1 Coordinate Systems	134
14.1.2 Topography	134
14.1.3 Drilling and Sampling Database	135
14.2 Geologic Model	137
14.3 Assay Capping and Compositing.....	140
14.3.1 Outliers	140
14.3.2 Compositing	143
14.3.3 Declustering Channel Sampling.....	145
14.4 Density	146
14.5 Variogram Analysis and Modeling	148
14.6 Block Model.....	148
14.7 Estimation Methodology.....	149
14.7.1 Virginius Vein	149
14.7.2 Terrible Vein	151
14.7.3 Yellow Rose	151
14.8 Model Validation.....	152
14.8.1 Visual Comparison	152
14.8.2 Comparative Statistics.....	154
14.8.3 Swath Plots	156
14.9 Resource Classification	157
14.9.1 Virginius/Footwall and Terrible Classification.....	158
14.9.2 Yellow Rose Classification	160
14.10 Mineral Resource Statement	161
14.11 Mineral Resource Sensitivity.....	165
14.12 Relevant Factors	170
15 Mineral Reserve Estimate.....	173
15.1 Introduction	173
15.2 Conversion Assumptions, Parameters and Methods.....	174
15.2.1 Mining Recovery.....	175
15.2.2 Dilution.....	175
15.2.3 Net Smelter Return.....	178
15.2.4 Cut-off Evaluation.....	182

15.3 Reserve Estimate	182
15.3.1 Relevant Factors	184
16 Mining Methods	185
16.1 Mining Methods	185
16.1.1 Mineralized Areas	185
16.1.2 Resue Mining	186
16.2 Geotechnical Parameters	188
16.2.1 Geomechanical Characterization	190
16.2.2 Geomechanical Domains and Rock Mass Properties	192
16.2.3 Mine Design Parameters	192
16.2.4 Stopping Sequence and Sill Pillars	193
16.3 Mine Design	193
16.3.1 Historically Mined Areas	193
16.3.2 Stope Design	196
16.3.3 May 2017 Resue Test Stope Discussion	198
16.3.4 Development Design	206
16.3.5 Mine Design	208
16.4 Production Schedule	210
16.4.1 Productivity Assumptions	210
16.4.2 Monthly Production Schedule	211
16.5 Mining Operations	214
16.5.1 Rehabilitation of Historic Workings	215
16.5.2 Resue Mining	215
16.5.3 Waste Rock	216
16.6 Mine Equipment, Key Materials and Projects	216
16.6.1 Mine Equipment and Key Materials	216
16.6.2 Projects	219
16.7 Ventilation	219
16.7.1 Airflow Requirements	220
16.7.2 Recommended Air Velocities and Airflow Limitations	221
16.7.3 Alimak Ventilation	221
16.7.4 General Stope Ventilation	221
16.7.5 General Mining Areas and Sequence	222
16.7.6 Ventilation Model Development	222
16.7.7 Specific Area Ventilation Requirements	224
16.7.8 Air Heating	228
16.7.9 Equipment and Infrastructure Summary	229
16.8 Mine Services	231

16.8.1 Hoisting.....	231
16.8.2 Compressed Air.....	231
16.8.3 Dewatering	232
16.8.4 Electrical	232
16.8.5 Health and Safety.....	232
16.8.6 Mining Labor.....	232
16.8.7 Grade Control.....	233
17 Recovery Methods	235
17.1 Introduction	235
17.2 Processing Methods.....	236
17.3 Process Design and Flowsheet Description	238
17.3.1 Run-of-Mine Storage and Crushing	239
17.3.2 Primary Rod Milling	240
17.3.3 Secondary Ball Milling.....	240
17.3.4 Bulk Lead Rougher Flotation.....	240
17.3.5 Zinc Rougher Flotation	241
17.3.6 Lead Cleaner Flotation.....	241
17.3.7 Zinc Cleaner Flotation	241
17.3.8 Lead Concentrate Thickening and Filtration	242
17.3.9 Zinc Concentration Thickening and Filtration.....	242
17.3.10 Tailings Thickening and Filtration	243
17.3.11 Reagent Mixing, Storage and Distribution	243
17.3.12 Raw Water Storage and Distribution	244
17.3.13 Process Water Storage and Distribution.....	244
17.3.14 HP and LP Air Services	244
17.4 Plant Design and Equipment Characteristics	245
17.5 Consumable Requirements	245
17.5.1 Electrical Power.....	245
17.5.2 Reagents	246
17.5.3 Process Consumables (Major Sources).....	247
17.6 Process Plant Performance	247
17.7 SRK Site Visit.....	250
17.7.1 Run-of Mine (ROM) Ore Storage	250
17.7.2 Primary and Secondary Crushing	250
17.7.3 Rod Mill Circuit	250
17.7.4 Ball Mill Circuit.....	251
17.7.5 Lead-Copper Rougher Flotation.....	251
17.7.6 Lead-Copper Cleaner Flotation.....	252

17.7.7 Zinc Rougher Flotation	253
17.7.8 Zinc Cleaner Flotation Circuit.....	253
17.7.9 Lead Concentrate Thickening and Filtration	253
17.7.10 Tailing Thickening and Filtration	253
17.7.11 Process Water Recycle.....	253
17.7.12 Analytical/Metallurgical Laboratory and Personnel.....	254
18 Project Infrastructure.....	255
18.1 Off-site Infrastructure and Product Logistics.....	255
18.1.1 Mine Access Road	255
18.1.2 Off-site Warehouse and Offices	258
18.1.3 Product Logistics	259
18.2 On-Site Infrastructure.....	260
18.2.1 Introduction.....	260
18.2.2 Access	262
18.2.3 Plant	262
18.2.4 Solid Waste Handling	262
18.2.5 Emergency Hoist.....	263
18.2.6 Water Systems	264
18.2.7 Compressed Air Systems.....	267
18.2.8 Power Supply System	267
18.2.9 Propane Supply	269
18.2.10 Fuel and Lubricant Storage.....	269
18.2.11 Surface Crusher Plant.....	269
18.2.12 Mine Administration and Dry Building	269
18.2.13 Railyard Building	270
18.2.14 Mill Reagent and Compressor Storage Building.....	270
18.2.15 Explosives Storage	274
18.2.16 Laboratory	274
18.2.17 Weigh-Scale.....	274
18.2.18 Security/ Gatehouse	274
18.2.19 Communications	274
18.3 Tailings Management Area	274
19 Market Studies and Contracts	280
19.1.1 Feasibility Study Metal Price Assumptions	280
19.1.2 Concentrate Market Study.....	280
19.2 Contracts and Status.....	283
20 Environmental Studies, Permitting and Social or Community Impact.....	284

20.1	Required Permits and Status	284
20.1.1	DRMS Program	284
20.1.2	CDPHE – Colorado Discharge Permit System	289
20.2	Environmental Study Results.....	290
20.2.1	Baseline Water Quality.....	291
20.2.2	Results of Geochemical Studies of Waste Rock and Tailings	295
20.3	Community Involvement	299
20.4	Operating and Post Closure Requirements and Plans	299
20.4.1	Post-Closure Water Management.....	299
20.4.2	Tailings Management Area	300
20.4.3	Shafts	300
20.4.4	Plant Site and Facilities.....	300
20.4.5	Portal	301
20.5	Closure Monitoring.....	301
20.6	Reclamation and Closure Cost Estimate	301
21	Capital and Operating Costs	302
21.1	Capital Cost Estimate.....	302
21.1.1	Capital Cost Assumptions and Qualifications	302
21.1.2	Capital Cost Summary	302
21.1.3	Processing Plant Capital Cost Estimate.....	303
21.1.4	Mining Capital Cost Estimate	305
21.1.5	Surface Capital Cost Estimate	305
21.1.6	Infrastructure Capital Cost Estimate	305
21.2	Operating Cost Estimate.....	306
21.2.1	Operating Costs Assumptions and Qualifications.....	306
21.2.2	Operating Cost Summary.....	307
21.2.3	Mining Operating Cost Estimate	307
21.2.4	Processing Plant Operating Cost Estimate.....	310
21.2.5	Maintenance Operating Cost	313
21.2.6	Surface Operating Cost Estimate.....	313
21.2.7	G&A Operating Cost Estimate	313
22	Economic Analysis	315
22.1	Principal Assumptions and Input Parameters.....	315
22.2	Cash Flow Forecasts and Annual Production Forecasts.....	315
22.3	Taxes, Royalties and Other Interests.....	320
22.3.1	Ownership Structure.....	320
22.4	Sensitivity Analysis.....	321

23 Adjacent Properties	322
24 Other Relevant Data and Information.....	323
24.1 Project Implementation	323
24.1.1 Current Status and overview	323
24.1.2 Recruiting, Onboarding and Training	323
25 Interpretation and Conclusions	330
25.1 Property Description and Ownership	330
25.2 Geology and Mineralization	330
25.3 Status of Exploration, Development and Operations.....	330
25.4 Mineral Processing and Metallurgical Testing	330
25.5 Mineral Resource Estimate	331
25.6 Mining and Mineral Reserves	332
25.7 Recovery Methods	333
25.8 Project Infrastructure.....	334
25.9 Environmental Studies and Permitting.....	335
25.10Capital and Operating Costs.....	335
25.11Economic Analysis	335
26 Recommendations	336
26.1 Mineral Resources	336
26.2 Mining Methods.....	336
26.3 Recovery Methods	337
26.4 Project Infrastructure.....	337
26.5 Environmental Studies and Permitting.....	338
26.6 Recommended Work Program Costs	339
27 References.....	340
28 Glossary.....	343
28.1 Mineral Resources	343
28.2 Mineral Reserves	343
28.3 Definition of Terms	344
28.4 Abbreviations	345

List of Tables

Table 1-1: Estimated Metal Recoveries for the Virginius-Revenue Mine	4
Table 1-2: OSMI Mineral Resource Estimate as of December 31, 2021 – SRK Consulting (U.S.), Inc.	6
Table 1-3: OSMI Mineral Reserves Estimate as of December 31, 2021 – SRK Consulting (U.S.), Inc.....	8
Table 1-4: Capital Cost Summary (US\$000's)	15

Table 1-5: Operating Cost Summary	16
Table 1-6: Pre-Tax and After-Tax Indicative Economic Results (US\$000's)	17
Table 2-1: Site Visit Participants.....	22
Table 4-1: Mining Claims Owned by OSMI	29
Table 4-2: Unpatented Mining Claims	31
Table 6-1: Ownership and Exploration History of the Virginius Vein and the Revenue Tunnel	40
Table 6-2: Historical Production from the Project as Reported by Tremlett in 1976 modified by R. Perry (2013)	42
Table 7-1: Stratigraphic Column for Rocks Exposed in the Project Area.....	45
Table 7-2: Age Dates of Mineralization from the Northwestern San Juan Mountains	51
Table 9-1: Exploration Work Completed Between 1966 and 2001	56
Table 9-2: Exploration Work Completed between 2012 and 2013.....	58
Table 10-1: Total Core Drilling on the Project	65
Table 10-2: Summary of Assays from 2016 OSMI Drilling Campaign	74
Table 11-1: Elements and Upper and Lower Detection Limits for ALS Code ME-ICP61	78
Table 11-2: Summary of Detection Limits and Laboratory Codes for OSMI Submissions	79
Table 11-3: Summary of Duplicate Samples Submitted During 2016.....	83
Table 13-1: Head Analyses for Master and Variability Composites	91
Table 13-2: Mineralogical Composition of Test Composites by QEMSCAN Analyses	92
Table 13-3: Bond Low Energy Impact and Abrasion Tests on Virginius Main Ore and Waste Samples.....	92
Table 13-4: Bond Rod Mill (RWi) and Ball Mill (BWi) Determinations.....	93
Table 13-5: Summary of Grind Size vs. Recovery and Cyanide Addition.....	94
Table 13-6: Summary of First Stage Lead and Zinc Cleaner Flotation vs. Re grind Size.....	97
Table 13-7: Summary of Locked-Cycle Test on Virginius Main Master Composite (Average of Cycles 5, 6, and 7).....	101
Table 13-8: Summary of Rougher Flotation Test on Virginius Main High Dilution Composite.....	102
Table 13-9: Summary of Rougher Flotation Tests on the Virginius Hanging Wall Variability Composite	103
Table 13-10: Summary of Rougher Flotation Test on the Virginius Master/Yellow Rose Variability Composite	104
Table 13-11: Summary of Locked Cycle Test on the Virginius High Dilution Variability Composite (Average of Cycles 4, 5 & 6)	106
Table 13-12: Summary of Locked-Cycle Test on the Virginius Hanging Wall Composite (Average of Cycles 4, 5 and 6).....	107
Table 13-13: Summary of Locked-Cycle Test on the Virginius Main/Yellow Rose Blend Variability Composite	107
Table 13-14: Thickener Sizing Parameters (Metric): Zinc Scavenger Flotation Tailing and Lead Cleaner Concentrate	108
Table 13-15: Lead Concentrate PneumaPress® Filtration Test Result	109
Table 13-16: Pressure Filtration Sizing Parameters - Zinc Scavenger Flotation Tailing and Lead Cleaner Concentrate	109

Table 13-17: Metallurgical Sample Description and Locations	110
Table 13-18: Variability Composite Predicted Ore Grades with Dilution.....	112
Table 13-19: Head Assays for Feasibility Study Master Composite and Variability Composites	112
Table 13-20: Mineral Occurrence in the Master Composite.....	113
Table 13-21: Sulfide Mineral Liberation in the Master Composite	113
Table 13-22: Bond Ball Mill and Rod Mill Work Indices on Variability and Master Composites.....	114
Table 13-23: Summary of Confirmatory Lead and Zinc Flotation Test Results	115
Table 13-24: Summary of Large Batch Lead and Zinc Flotation Test Results.....	117
Table 13-25: Summary of Locked-Cycle Test Results on the Master Composite (Average of Last 3 Cycles)	120
Table 13-26: Summary of Thickening Test Results on Feasibility and Prefeasibility Master Composite Flotation Tailing and Lead Concentrate	121
Table 13-27: Summary of Pressure Filtration Tests on Master Composite Flotation Tailings	122
Table 13-28: Multi-Element Analyses on Lead and Zinc Concentrates and Final Flotation Tailing.....	122
Table 13-29: Acid-Base Accounting Results on Master Composite Flotation Tailings	124
Table 13-30: Summary of Relevant Test Results From Feasibility and Prefeasibility Metallurgical Programs	126
Table 13-31: Summary of Concentrate Grades from Relevant Test Results from Feasibility and Prefeasibility Metallurgical Programs.....	126
Table 13-32: Estimated Metal Recoveries for the Virginius-Revenue Mine.....	130
Table 13-33: Reagent Usage and Dosage Requirements for Processing Virginius Main Ore	131
Table 13-34: Key Process Design Parameters	131
Table 14-1: Drilling Statistics for the Yellow Rose.....	136
Table 14-2: Channel Sample Statistics for the Yellow Rose	136
Table 14-3: Drilling Statistics for the Virginius.....	136
Table 14-4: Channel Sampling Statistics for Virginius	137
Table 14-5: Virginius Veins and Modelling Codes.....	139
Table 14-6: Assay Capping by Deposit	140
Table 14-7: Summary of Raw vs. Capped Values for Estimated Veins (Absent Values Reset to Detection).....	142
Table 14-8: Summary Statistics of Composited Values in Main Veins	144
Table 14-9: Summary of Density Sampling in Yellow Rose Drilling.....	147
Table 14-10: Summary of 2016 Density Measurements by Rock Type.....	148
Table 14-11: Summary of 2021 Density Testwork	148
Table 14-12: Summary of Block Model Origin.....	149
Table 14-13: Summary of Sensitivity Analysis on Parameters for Estimation on Virginius Vein	151
Table 14-14: Summary of Final Estimation Parameters for Virginius and FW Vein	151
Table 14-15: Summary of Final Estimation Parameters for Terrible Vein.....	151
Table 14-16: Summary of Final Estimation Parameters for Yellow Rose Vein.....	152

Table 14-17: Summary of Comparison between Composite (declustered) vs. ID2 and NN Block Estimates per Vein.....	155
Table 14-18: Process Plant Recoveries by Concentrate Used in NSR Calculations for Geology	162
Table 14-19: NSR Calculation Commodity Price Assumptions.....	162
Table 14-20: Summary of Incremental Mining, Processing and G&A Costs.....	163
Table 14-21: OSMI Mineral Resource Estimate as of December 31, 2021 – SRK Consulting (U.S.), Inc.	164
Table 14-22: Grade Tonnage Sensitivity Virginius Vein, Split by M&I and Inferred.....	166
Table 14-23: Grade Tonnage Sensitivity Footwall Vein, Split by M&I and Inferred	167
Table 14-24: Grade Tonnage Sensitivity Terrible Vein Split by M&I, and Inferred.....	168
Table 14-25: Grade Tonnage Sensitivity Yellow Rose Vein Split by M&I, and Inferred.....	169
Table 15-1: April 2016 Test Stope Results.....	177
Table 15-2: Process Plant Recoveries by Concentrate.....	178
Table 15-3: NSR Calculation Commodity Price Assumptions.....	179
Table 15-4: Example NSR Calculation	180
Table 15-5: Estimated Total Operating Cost	182
Table 15-6: OSMI Mineral Reserves Estimate as of December 31, 2021 – SRK Consulting (U.S.), Inc.	183
Table 16-1: Summary of Planned Opening Dimensions	189
Table 16-2: Summary of 2017 Laboratory Testing Program	191
Table 16-3: Summary of Rock Mass Quality, Virginius North Area	192
Table 16-4: Ground Support Requirements (Barton Method).....	193
Table 16-5: May 2017 Test Stope Measurements and Dilution Calculation	204
Table 16-6: May 2017 Test Stope Drilling Productivity Results	205
Table 16-7: Productivity Rates	210
Table 16-8: Monthly Mining Schedule	212
Table 16-9: Mining Equipment List.....	216
Table 16-10: Key Mine Projects (Costs Provided in OSMI Budget).....	219
Table 16-11: Minimum Total Mine Airflow Requirements (Excluding Leakage).....	221
Table 16-12: Airway Friction Factors.....	223
Table 16-13: Monthly Gas Usage (LPG).....	229
Table 16-14: Fan/Ducts Registered.....	229
Table 16-15: Mining Personnel Position and Number.....	233
Table 17-1: Key Process Design Criteria Parameters.....	239
Table 17-2: Summary of the Power Consumption Rates per Processing Plant Area (Based on 91,390 st/y)	246
Table 17-3: Reagent Usage (Based on 91,390 st/y).....	247
Table 17-4: Process Consumables Usage (91,390 st/y).....	247
Table 17-5: OSM Concentrator Commissioning Performance (September - December 2021).....	249
Table 18-1: Summary of Filtered Tailings Laboratory Direct Shear Test Results	275

Table 18-2: Summary of FOS Stability Analysis	278
Table 19-1: Metal Price Forecast Comparisons (US\$).....	280
Table 19-2: Expected Concentrate Specifications	282
Table 19-3: Forecast Lead Concentrate Sales Terms	283
Table 19-4: Forecast Zinc Concentrate Sales Terms.....	283
Table 20-1: Existing Environmental and Operational Permits.....	285
Table 20-2: Inactive Site Water Quality Sampling Station Summary	291
Table 20-3: Active Area-Wide Water Quality Sampling Station Summary.....	291
Table 20-4: Outfall 002A Water Quality Data	294
Table 20-5: Waste Rock Synthetic Precipitation Leachate Procedure Results.....	297
Table 20-6: Tailings SPLP Results from Mill Commissioning	298
Table 21-1: Capital Summary (in US\$000's).....	303
Table 21-2: Pre-Production Capitalized Operating Cost (US\$000's).....	303
Table 21-3: Concentrator Upgrade Costs.....	304
Table 21-4: Process Plan Capex Forecast.....	304
Table 21-5: Process Plant Capital Summary Breakdown (US\$ 000's)	304
Table 21-6: Mine Capital Cost Summary (US\$ 000's)	305
Table 21-7: Infrastructure Capital Summary (US\$000's)	306
Table 21-8: Burden Cost Buildup	307
Table 21-9: Operating Cost Summary.....	307
Table 21-10: Mining Operating Cost by Activity	308
Table 21-11: Mining Activity Costs and Productivities.....	309
Table 21-12: Summary of Operating Costs – Processing Area (US\$000's)	310
Table 21-13: Electrical Consumption and Costs (based on 91,390 st/y)	311
Table 21-14: Reagent Costs (Based on 576,997 LoM st Processed).....	312
Table 21-15: Non-Reagent Consumables Costs (Based on 91,390 st/y)	312
Table 21-16: Maintenance Operating Costs (US\$000's).....	313
Table 21-17: G&A Operating Cost Summary	314
Table 22-1: Basic Model Parameters	315
Table 22-2: Mine Production Summary	316
Table 22-3: Mill Production Summary	316
Table 22-4: Concentrate Production Summary	317
Table 22-5: Net Smelter Return.....	317
Table 22-6: Life-of-Mine Indicative Pre-Tax and After -Tax Economic Results (in US\$000's)	318
Table 22-7: Life-of-Mine Total Production Cost Contribution ⁽¹⁾	320
Table 24-1: OSMI Project Staffing by Period.....	326
Table 26-1: Summary of Costs for Recommended Work.....	339
Table 28-1: Definition of Terms	344

Table 28-2: Abbreviations.....345

List of Figures

Figure 1-1: Mine Design Colored by NSR – Rotated View Looking Southwest (Looking from the Portal) 10

Figure 1-2: Existing Surface Infrastructure 13

Figure 4-1: Location Map.....25

Figure 4-2: Location Map Showing Drainage Basins26

Figure 4-3: OSMI Claim Ownership.....28

Figure 7-1: Western San Juan Caldera Complex.....43

Figure 7-2: Generalized Geologic Map of the Silverton / Ouray / Telluride Area44

Figure 7-3: Example of the Role of Dikes in the Geological Model, Completed During Initial Geological Review by SRK During 2015 (Section viewing NW)48

Figure 7-4: Important Structural Features and Principal Veins in the Project Area.....49

Figure 7-5: Revenue Tunnel and the Yellow Rose, Terrible and Virginius Veins52

Figure 9-1: Historical Underground Samples57

Figure 9-2: Historical Sampling within F9 Stope58

Figure 9-3: Collar Plot Showing Sampling and Drilling Collar Locations - 2012 to 201359

Figure 9-4: OSMI Sampling Locations.....60

Figure 9-5: Location of OSMI Production Sampling61

Figure 9-6: Summary of Exploration Sampling by Year62

Figure 10-1: Drillhole Traces (blue) Covering the Virginius, Footwall and Terrible Veins, Plotted Against Surface Trace of Veins (Red).....67

Figure 10-2: Drillhole Traces (Blue) Covering the Yellow Rose Veins (Red).....68

Figure 10-3: Example of Cross Section Showing Interaction of Vein to Drilling Intersection.....69

Figure 10-4: Example of Historical Logging Sheets by Ranchers (1983)70

Figure 10-5: Cross Section showing Example of OSMI Drilling Sections Relative to Vein72

Figure 10-6: Collar (top) and Exploration (bottom) plan of Blue Grass Drilling, Dated July 23, 2020.....73

Figure 11-1: Analysis of Assays for CRM 601 Submissions per Element.....81

Figure 11-2: Analysis of Blank Samples for Ag during 2016 OSMI Submissions82

Figure 11-3: Example of XY Scatter Chart to Compare Original to Repeat Assays83

Figure 12-3 Example of face mapping (left) and back mapping (right) as captured in Maptek Vulcan.87

Figure 13-1: Metal Recovery into the Lead and Zinc Rougher Concentrates vs. Grind Size95

Figure 13-2: Metal Recovery to the Lead and Zinc Rougher Concentrates vs. Cyanide Addition.....95

Figure 13-3: Metal Recovery into the Lead Rougher Flotation Concentrate vs. Retention Time.....96

Figure 13-4: Lead Recovery into First Stage Cleaner Concentrate vs. Retention Time98

Figure 13-5: Metal Recovery during First Stage Lead Cleaner Flotation vs. Retention Time (No Re grind)98

Figure 13-6: Locked-Cycle Test Flowsheet.....99

Figure 13-7: Rougher Flotation Metal Recoveries vs. Retention Time: Virginius High Dilution Variability Composite.....	103
Figure 13-8: Rougher Flotation Metal Recoveries vs. Retention Time: Hanging Wall Variability Composite	104
Figure 13-9: Rougher Flotation Metal Recoveries vs. Retention Time: Master/Yellow Rose Variability Composite.....	105
Figure 13-10: Feasibility Study Metallurgical Sample Locations	111
Figure 13-11: Lead Cleaner-2 Flotation vs. Retention Time	118
Figure 13-12: Zinc Cleaner-2 Flotation vs. Retention Time.....	119
Figure 13-13: Silver Recovery into the Pb Concentrate vs. Feed Grade	127
Figure 13-14: Gold Recovery into the Pb Concentrate vs. Feed Grade	127
Figure 13-15: Lead Recovery into the Pb Concentrate vs. Feed Grade	128
Figure 13-16: Copper Recovery into the Pb Concentrate vs. Feed Grade	128
Figure 13-17: Zinc Recovery into the Pb Concentrate vs. Feed Grade	129
Figure 13-18: Zinc Recovery into the Zn Concentrate vs. Feed Grade	129
Figure 14-1: Example of Geo-Referenced Historical Maps for the Virginius Vein	138
Figure 14-2: Plan Showing Modelled Geological Domains (Veins) at Yellow Rose.....	138
Figure 14-3: Oblique View Showing Geological Domains (Veins) for the Virginius Vein.....	139
Figure 14-4: Log Probability of Sample Lengths in Veins for the Virginius Vein (kzone1) and Yellow Rose Vein	143
Figure 14-5: Example of Declustering Investigation in KZONE 1, Showing Raw Samples as Crosses and Declustered Mean for Same Area as Points	145
Figure 14-6: Long Section, Showing Estimation Parameter Ellipse and Stope Outlines Looking Southwest	150
Figure 14-7: Long Sections Showing Ag (oz/st) Estimates Versus Composite Grades.....	153
Figure 14-8: Example of Swath Plots (Revenue and Yellow Rose) Used to Review Block Estimates versus Composites Along Strike of Each Vein.....	157
Figure 14-9: Search Pass Estimated for Blocks of Virginius Vein (Long Section) Looking Southwest.....	159
Figure 14-10: Long Section (Looking Southwest) of Virginius Vein Showing Final Classification	159
Figure 14-11: Long Section (Looking Southwest) of Footwall Vein Showing Final Classification	160
Figure 14-12: Long Section (Looking Southwest) of Terrible Vein showing Final Classification	160
Figure 14-13: Long Section (Looking Northeast) of Yellow Rose Vein Classification.....	161
Figure 15-1: OSMI Site Layout and Vein Location	174
Figure 15-2: Resue Mining Test Stope Layout.....	176
Figure 15-3: Stope Location	176
Figure 15-4: Resue Test Stope Photo	177
Figure 16-1: Long Section of the Virginius Area (Looking Southwest) with Historically Mined Areas, Showing Current Northing and Level Nomenclature.....	185
Figure 16-2: Resue Mining Method Details – Long Section.....	187
Figure 16-3: Resue Mining Method Details – Long Section on Left, Cross Section on Right.....	188
Figure 16-4: Longitudinal Section through the Virginius Vein, showing the Stratigraphy and Historic Mining	194

Figure 16-5: Long Section View of Mining Shapes in the Virginius Area 195

Figure 16-6: Virginius Main Vein Resource Blocks – Colored by NSR 196

Figure 16-7: Virginius Footwall Vein Resource Blocks – Colored by NSR 196

Figure 16-8: Terrible Vein Resource Blocks – Colored by NSR..... 197

Figure 16-9: Yellow Rose Main Vein Resource Blocks – Colored by NSR..... 197

Figure 16-10: Resue Drill Hole Pattern Used the 561 Test Stope 199

Figure 16-11: Test Stope Area and Sequence 201

Figure 16-12: 561 2017 Test Stope Measured Overbreak Results..... 203

Figure 16-13: Revenue and Terrible Area Planned Development (Rotated View- Looking Toward Portal).. 207

Figure 16-14: Yellow Rose Area Planned Development (Rotated View- Looking Toward Portal)..... 207

Figure 16-15: Mine Design Colored by NSR – Rotated View Looking Southwest (Looking from the Portal) 208

Figure 16-16: Mine Design Colored by NSR – Rotated View Looking Northeast (Looking Toward the Portal) 209

Figure 16-17: Mine Design Colored by Mining Width – Rotated View Looking Southwest (Looking From the Portal) 209

Figure 16-18: Mine Production Schedule, Colored by Time-Period - Rotated View Looking Southwest (Looking from the Portal) 214

Figure 16-19: Overall Ventilation Layout Including Stopes and Development 220

Figure 16-20: Mining Areas Developed for Ventilation 222

Figure 16-21: Main Exhaust Fan Installation Location 223

Figure 16-22: Shaft 1 Duct Configuration (Example) 225

Figure 16-23: General Upper Virginius Ventilation Layout 226

Figure 16-24: Mill Ventilation 228

Figure 16-25. Installed Air Heater..... 228

Figure 17-1: Simplified Process Flowsheet with the Principal Process Areas 237

Figure 18-1: Photograph of Winter Access Road 256

Figure 18-2: Alpine Safety Operating Plan – Regional Slide Paths 257

Figure 18-3: Photograph of the Access Road and the Height Limit for the Road in the Rock Overhang 258

Figure 18-4: Ouray Administrative/Warehouse Building and Yard (Street View)..... 259

Figure 18-5: Ouray Administrative/Warehouse Building and Yard..... 259

Figure 18-6: Existing Surface Infrastructure 261

Figure 18-7: Planned Surface Infrastructure 262

Figure 18-8: Emergency Hoist and Headframe Photos..... 264

Figure 18-9: Passive Water Treatment System Cross-Section (Schematic) 266

Table 18-10: Site Connected Power Requirements 267

Figure 18-11: Upper-Level Plan View of New Change house Area 271

Figure 18-12: Ground Level Plan View of New Switchyard Building..... 272

Figure 18-13: General Arrangement of Compressor/Reagent Building 273

Figure 18-14: Plan View of TSF Dry Stack Pile with Limits of Pile Shown in Red 276

Figure 18-15: Required Tailings Storage Capacity Curve.....	277
Figure 18-16: Perspective View of the TSF Piles Looking Towards Southwest After 5 Years of Production	278
Figure 18-17: Perspective View of the TSF Piles Looking Towards Southwest After Life-of-Mine.....	278
Figure 18-18: Example Slope Stability Output for Atlas North-Northeast Cross Section A	279
Figure 20-1: Area-Wide Surface Water and Groundwater Sample Locations	293
Figure 22-1: Project After-Tax Metrics.....	319
Figure 22-2: After-Tax NPV (5%) Sensitivity Chart (US\$000's)	321
Figure 23-1: Location of the Camp Bird Mine Relative to the OSMI Boundaries	322
Figure 24-1: OSMI Organization Chart.....	325
Figure 24-2: Stope School Objective Outline	328

1 Summary

This report is prepared as a Technical Report for Ouray Silver Mines, Inc. (OSMI or Company) and Aurcana Silver Corporation (Aurcana) by SRK Consulting (U.S.), Inc. (SRK) and is based on a 2022 Revenue-Virginius Mine (the Project) Feasibility Study (FS) update.

1.1 Property Description and Ownership

The Project is located in southwestern Colorado approximately 5.5 miles (mi) southwest of the town of Ouray. The Revenue Tunnel, the site of the current surface activity, is located at longitude 107.750° W, latitude 37.974° N (mine grid coordinates of 100,630 ft E, 99,100 ft N).

The Project is a past silver producer in the Sneffels Mining District. Silver was reportedly discovered at the Project in 1876 with underground production beginning in 1880 and continuing through 1906 when, according to Ranchers Exploration and Development Corp. (Ranchers), the mine flooded (Ranchers, 1980). Additional testwork and planning began on the property in 2012 by Star Mine Operations (Star Mines). In May 2014 Star Mines sold a portion of mine ownership to Fortune Revenue Silver Mines, Inc. (FRSM), a wholly owned subsidiary of Fortune Minerals Limited (FML), which operated the property for a short time under this structure. In October 2014, FRSM received senior secured financing, (the PFA), guaranteed by FML, from LRC-FRSM, LLC (LRC-FRSM), and used that financing plus shares of FML to acquire the balance of 100% of the assets and finalize commissioning of the mine. After default on the PFA, on July 17, 2015, Fortune Minerals and LRC-FRSM entered into a Master Restructuring Agreement (MRA). As part of the MRA, FML transferred 100% ownership of FRSM to LRC-FRSM II, LLC (an affiliate of LRC-FRSM) and on July 21, 2015, the name of the operating entity was changed from Fortune Revenue Silver Mines, Inc. to Ouray Silver Mines, Inc (OSMI).

On December 27, 2018, Aurcana completed a reverse takeover transaction pursuant to a plan of arrangement under the CBCA (the Arrangement) with OSMI, which holds the “Revenue-Virginius Mine” located in Colorado, pursuant to an arrangement agreement dated September 20, 2018, between the Company and LRC-FRSM LLC and LRC-FRSM II LLC (collectively, the LRC Group). Under the Arrangement, Aurcana acquired all of the issued and outstanding shares of common stock of OSMI from the LRC Group on a debt free basis in exchange for newly issued common shares of Aurcana.

On March 31, 2020, pursuant to a definitive agreement between OSMI and Caldera Mineral Resources (Caldera), the Company closed the acquisition of the Blue Grass claim located on the Virginius Vein contiguous to the Revenue-Virginius Mine. In return, Caldera received certain non-core claims of the Revenue-Virginius Mine from OSMI. The swap of mineral properties has been considered a non-monetary transaction for which the fair value of the asset received was not reliably measurable. As a result, the original carrying value of the properties given up by the Company has been allocated to the Blue Grass claim acquired from Caldera. Upon the completion of the swap, Blue Grass claim became a part of the Revenue-Virginius Mine.

1.2 Geology and Mineralization

The Virginius, Terrible and Yellow Rose veins located within the current OSMI property are the focus for the current Mineral Resource update. All three are quartz veins containing silver (Ag), gold (Au), copper (Cu), lead (Pb) and zinc (Zn) minerals hosted primarily in the San Juan volcanic rocks. Veins

range from several inches up to 6 ft in width, with a resource average of approximately 1.1 ft, and have been mined historically and drilled over a vertical extent of over 3,000 ft. The Virginius Vein has been mapped at surface by the U.S. Geological Survey (USGS) over a distance of approximately 11,700 feet (ft), the Terrible Vein has been traced for over 4,000 ft and the Yellow Rose up to 16,000 ft extending off the current property limits.

Mineralization found in the Virginius, Terrible and Yellow Rose veins is interpreted as epithermal (formed at shallow depths and low to medium temperatures). Some workers are of the opinion that it may also be interpreted as deep epithermal or shallow mesothermal. The Virginius has been previously described to be of shallow emplacement and it hosts galena, sphalerite, pyrite, tetrahedrite arsenopyrite, marcasite, polybasite and minor covellite. Gangue minerals include quartz, barite, sericite, calcite, rhodochrosite, ankerite, siderite and other carbonate minerals. Some authors have reported adularia, and other more obscure silicates, carbonates and sulfates. Alteration minerals include sericite, beidellite and other clays as well as iron and magnesium oxides.

Mineralization is described as massive, occurring in nodules and bands in association with calcite. Galena was described as coarse-grained with euhedral crystals up to 3.5 inches long. Quartz occurs as rhythmically banded veins characteristic of low sulfidation epithermal vein development.

1.3 Status of Exploration, Development and Operations

The Project has been mined historically at various periods. OSMI also completed a validation study of the historical database, which included translating the historical descriptive drilling logs into a series of logging codes in the current database. There have been five stages of drilling at the Project, which included Federal (12 holes for 6,395 ft), Ranchers (337 holes for 84,729 ft), Sunshine (18 holes for 6,567 ft, and Star Mines (103 holes for 42,061 ft), all via surface or underground rigs. In addition to the underground drilling a total of 2,331 channel samples have been taken by various owners. The validation work has been extended to both diamond drilling and underground channel sampling. In 2016 OSMI also completed a data capture and revised survey of the historical underground workings from historical maps, to increase the confidence in the spatial location of the sampling.

In 2016, OSMI drilled 42 NQ core holes from underground in the Monongahela (Virginius) Vein using an underground drilling rig with access from four exploration drifts (two in the hangingwall and two in the footwall of the vein).

All 2016 drillhole collars were surveyed by an OSMI surveyor. Downhole surveys were completed on the majority of drillholes by the drilling company using a REFLEX EZ-SHOT™ tool. Downhole surveys were not completed in some of the drillholes due to tool availability and safety concerns with use of survey equipment in steep up-holes. The drillholes were surveyed at varying intervals along the hole and at the bottom of the hole. The drillholes, which did receive downhole surveys, did not show significant deviation from planned orientations.

1.4 Mineral Processing and Metallurgical Testing

On behalf of OSMI, SRK designed and supervised both prefeasibility-level (PFS) and feasibility-level (FS) metallurgical development programs for the Revenue-Virginius Project. The PFS metallurgical program was fully documented in SRK's PFS, "Prefeasibility Study Report – Revenue Virginius Mine – Ouray Colorado", August 3, 2016 (PFS). The results of the FS metallurgical program are detailed in this FS report. For the purposes of continuity, the key results from the PFS metallurgical program are

also presented in this report. Both metallurgical programs were conducted by FLSmidth USA, Inc. (previously Dawson Metallurgical Laboratory). The PFS metallurgical program was conducted on a bulk 1-ton (t) master composite representing the Virginius Main Vein and on variability composites characteristic of the Virginius Footwall Vein, and the Yellow Rose Vein. The FS metallurgical program was conducted on a master composite formulated to represent the weighted average ore contribution from the various mining areas of the mine and on five variability composites representing ore from selected areas of the Virginius Main Vein, Virginius Footwall Vein and the Yellow Rose Vein. The ore is a complex polymetallic containing gold, silver, lead, copper and zinc. Silver is the metal of primary importance and is associated primarily with the copper mineralization (tetrahedrite).

FS level metallurgical studies were based on the outcomes of the PFS metallurgical program and resulted in further optimization of the flotation process to recover the contained metal values in separate lead and zinc cleaner flotation concentrates. A separate copper concentrate was not produced. This program was conducted on variability composites that represented spatial and grade variations within the Virginius Main Vein, the Virginius Footwall Vein and the Yellow Rose Vein, as well as a master composite that was formulated to represent the weighted average contribution from these veins during the first five years of mining. Generally, lead concentrates containing about 65% lead and over 250 ounce per short ton (oz/st) silver and zinc concentrates containing about 54% Zn and 15 to 20 oz/st silver were consistently produced.

Metal recoveries were estimated for the ore grade ranges shown in Table 1-1 and the following general observations can be made:

- Silver recovery is similar to the PFS with recoveries into the lead concentrate ranging from 93% to 95% depending on feed grade
- Gold recovery into the lead concentrate ranges from 58% to 68% with an additional 4 to 6% recovery into the zinc concentrate depending upon feed grade
- Lead recovery into the lead concentrate is very consistent at 94% to 95% and relatively independent of feed grade
- Copper recovery into the lead concentrate ranges from 84% to 91% depending upon feed grade
- Zinc recovery into the zinc concentrate is estimated at 60% to 86% depending upon feed grade

Multi-element analyses were conducted on the final lead and zinc concentrates produced from locked-cycle tests on the master composite. Significant quantities of arsenic and antimony were found in the lead concentrate. The zinc concentrate contained significant levels of arsenic and cadmium.

Table 1-1: Estimated Metal Recoveries for the Virginius-Revenue Mine

Silver Recovery Estimate

Ore Grade Range (oz/st Ag)			
Low	10.0	20.0	30.0
High	20.0	30.0	47.0
Estimated Silver Recovery (%)			
Pb Conc.	93	94	95
Zn Conc.	1	1	1

Gold Recovery Estimate

Ore Grade Range (oz/st Au)			
Low	0.005	0.040	0.079
High	0.040	0.079	0.100
Estimated Gold Recovery (%)			
Pb Conc.	58	63	68
Zn Conc.	6	5	4

Lead Recovery Estimate

Ore Grade Range (Pb %)			
Low	1.0	2.1	5.0
High	2.1	5.0	8.5
Estimated Lead Recovery (%)			
Pb Conc.	94	94	95
Zn Conc.	1	1	1

Copper Recovery Estimate

Ore Grade Range (Cu %)			
Low	0.06	0.20	0.30
High	0.20	0.30	0.50
Estimated Copper Recovery (%)			
Pb Conc.	84	87	91
Zn Conc.	2	2	2

Zinc Recovery Estimate

Ore Grade Range (Zn %)			
Low	0.5	1.2	3.0
High	1.2	3.0	5.0
Estimated Zinc Recovery (%)			
Pb Conc.	31	23	10
Zn Conc.	60	71	86

Source: SRK, 2017

1.5 Mineral Resource Estimate

SRK has produced updated Mineral Resource estimates (MRE) for Ag, Au, Cu, Pb and Zn on three main vein systems, namely the Virginius, Terrible and Yellow Rose systems. All three veins have been explored and mined to various degrees in the past.

An updated geological model has been produced by SRK based initially on the main lithological units, and then via grades to provide the best estimate of the location of the mineralization within the geological units. All results from channel samples and drilling at the Project contained within the wireframes have been used in the MRE.

SRK has undertaken geological modelling to construct updated mineralization wireframes for the Virginius Vein system, Terrible Vein and the Yellow Rose Vein systems. SRK used the 3D solids created in Leapfrog to code the drillholes to differentiate between mineralization and waste and undertook statistical and geostatistical analyses on the composited data, as constrained by the modelled wireframes.

SRK has produced grade estimates for Ag, Au, Cu, Pb, Zn using an Inverse Distance Squared (ID2) algorithm, using a combined drilling and channel sampling database. To reduce the potential impact of localized high grades overly influencing the estimates, SRK has declustered the channel samples to 50 ft x 50 ft x 50 ft panels prior to estimation and has weighted the samples during grade estimation by their respective declustered values.

The Mineral Resource classification uses the Canadian Institute of Mining, Metallurgy and Petroleum (CIM) Definition Standards - For Mineral Resources and Mineral Reserves, prepared by the CIM Standing Committee on Reserve Definitions and adopted by CIM Council on May 14, 2014. The Resources at the Project have been classified as Measured, Indicated and Inferred at Yellow Rose and Virginius Veins. The Terrible Vein has been limited to Indicated and Inferred, whereby Indicated material is focused on diamond drilling completed from surface by previous owners.

The current proposed mining method for the Project will result in all material within an established stope being mined, and therefore the direct application of a cut-off grade (CoG) on a block-by-block basis is not considered appropriate for the Project. SRK has accounted for the CoG during the classification of Measured and Indicated material by working with OSMI staff on potential mining areas. Once an area was identified SRK analyzed the blocks based on the confidence criteria laid out in Section 14.9, and coding the model with the Net Smelter Return (NSR) value. Each area has then been evaluated to ensure the defined areas remain above the NSR CoG.

In comparison, for the inferred resources SRK does not consider there to be sufficient confidence in the estimates to define the edges of any potential stope areas. For the purpose of defining the potential for economic extractions, SRK assumed a NSR cut-off of US\$325/st using the incremental cut-off grade, and the final classification and grade cut-offs have been reviewed on long sections to ensure continuity.

The updated Mineral Resource for the Project with an effective date of December 31, 2021, is presented in Table 1-2.

Table 1-2: OSMI Mineral Resource Estimate as of December 31, 2021 – SRK Consulting (U.S.), Inc.

RESCAT	Vein	Tons (kst)	Density (t/ft ³)	Au (oz/t)	Ag (oz/t)	Pb (%)	Zn (%)	Cu (%)	Au (koz)	Ag (koz)	Pb (klbs)	Zn (klbs)	Cu (klbs)
Measured	Virginius Vein	235	10.04	0.07	21.41	5.01	1.89	0.24	16	5,038	23,593	8,883	1,125
	Footwall	28	10.04	0.04	45.78	7.35	2.47	0.59	1	1,292	4,152	1,394	335
	Terrible	0	0.00	0	0	0	0	0	0	0	0	0	0
	Yellow Rose	43	10.04	0.06	22.14	4.51	2.53	0.17	2	942	3,842	2,154	148
<i>Measured</i>	<i>Subtotal</i>	<i>306</i>	<i>10.04</i>	<i>0.06</i>	<i>23.8</i>	<i>5.38</i>	<i>2.07</i>	<i>0.30</i>	<i>20</i>	<i>7,272</i>	<i>31,586</i>	<i>12,430</i>	<i>1,608</i>
Indicated	Virginius Vein	333	10.04	0.06	23.90	4.30	2.51	0.25	21	7,963	28,651	16,713	1,691
	Footwall	91	10.04	0.03	17.88	3.37	1.20	0.29	3	1,633	6,160	2,198	521
	Terrible	54	10.04	0.05	17.49	7.41	1.46	0.14	3	943	7,984	1,572	150
	Yellow Rose	229	10.04	0.03	11.80	2.44	1.69	0.10	8	2,696	11,153	7,725	439
<i>Indicated</i>	<i>Subtotal</i>	<i>707</i>	<i>10.04</i>	<i>0.05</i>	<i>18.7</i>	<i>3.81</i>	<i>1.98</i>	<i>0.20</i>	<i>34</i>	<i>13,234</i>	<i>53,947</i>	<i>28,208</i>	<i>2,801</i>
M&I	Virginius Vein	568	10.04	0.06	22.87	4.59	2.25	0.25	37	13,001	52,244	25,596	2,816
	Footwall	120	10.04	0.03	24.47	4.31	1.50	0.36	4	2,925	10,312	3,591	856
	Terrible	54	10.04	0.05	17.49	7.41	1.46	0.14	3	943	7,984	1,572	150
	Yellow Rose	271	10.04	0.04	13.42	2.77	1.82	0.11	10	3,638	14,994	9,879	587
<i>M&I</i>	<i>Subtotal</i>	<i>1,013</i>	<i>10.04</i>	<i>0.05</i>	<i>20.5</i>	<i>4.23</i>	<i>1.98</i>	<i>0.23</i>	<i>53</i>	<i>20,506</i>	<i>85,534</i>	<i>40,638</i>	<i>4,409</i>
Inferred*	Virginius Vein	164	10.04	0.08	35.8	6.63	3.12	0.34	12	5,864	21,694	10,224	1,116
	Footwall	6	10.04	0.05	30.2	3.66	1.18	0.38	0	172	416	135	43
	Terrible	55	10.04	0.12	29.4	7.07	1.31	0.11	7	1,625	7,815	1,448	124
	Yellow Rose	95	10.04	0.03	23.3	1.45	1.90	0.17	3	2,220	2,755	3,609	318
<i>Inferred</i>	<i>Subtotal</i>	<i>320</i>	<i>10.04</i>	<i>0.07</i>	<i>30.7</i>	<i>4.99</i>	<i>2.43</i>	<i>0.25</i>	<i>23</i>	<i>9,881</i>	<i>32,680</i>	<i>15,416</i>	<i>1,601</i>

- Mineral Resources are reported inclusive of the Mineral Reserves.
- Mineral Resources are not Mineral Reserves and do not have demonstrated economic viability. There is no certainty that all or any part of the Mineral Resources estimated will be converted into Mineral Reserves.
- Mineral Resource tonnage and contained metal have been rounded to reflect the accuracy of the estimate, and numbers may not add due to rounding.
- All Measured and Indicated estimates with the defined wireframes are considered to have potential for economic extraction as the entire level will be mined
- Inferred Mineral Resources are limited using a NSR cut-off US\$200/st.
- Metal price assumptions considered for the calculation of NSR are: Gold (US\$1,765/oz), Silver (US\$23.75/oz), Lead (US\$0.95/lb), and Zinc (US\$1.15/lb).
- Cut-off calculations assume average metallurgical recoveries equal to: Gold (68%), Silver (94%), Lead (95%), Copper (91%) and Zinc (94%).
- The resources were estimated by Benjamin Parsons, BSc, MSc Geology, MAusIMM (CP) #222568 of SRK, a Qualified Person

Source: SRK, 2022

1.6 Mineral Reserve Estimate

Based on the orientation and width of the mineralization, review of historic mining and available geotechnical information, a rescue mining method is appropriate where waste rock serves as backfill as the stope is advanced in an overhand manner. This method is highly selective and allows for mining narrow widths down to 6 inches. The design assumes mining of large panels where raises/infrastructure is used for the entire panel length. There may be places along the panel which fall below CoG; however, these must be mined due to the mining method and infrastructure. These lower grade areas are included in the reserve, however the block NSR is above cut-off.

All mineral reserve tonnages are expressed as dry short tons (st) (i.e., no moisture) and are based on the density values stored in the block model. Inferred material is not included in the design. Mining dilution has also been applied with a grade of zero.

A 3D mine design has been created representing the reserve areas. Dilution is included in the reserve and a 100% mining recovery of the planned mining areas is assumed.

An NSR approach was used and takes into account revenue for four elements (Zn, Pb, Ag and Au) and production of two concentrates (lead concentrate and zinc concentrate). Planned mining areas were evaluated on a value basis to ensure they were economic.

Mineral reserves were classified using the 2014 CIM Definition Standards. The mineral reserve statement for OSMI is presented in Table 1-3. The mineral reserve estimate is effective as of December 31, 2021.

Table 1-3: OSMI Mineral Reserves Estimate as of December 31, 2021 – SRK Consulting (U.S.), Inc.

Area	Description	Tons (kst)	Ag (oz/st)	Au (oz/st)	Pb (%)	Zn (%)	Contained Ag (koz)	Contained Au (koz)	Contained Pb (klb)	Contained Zn (klb)	NSR (US\$/st)
Virginius	Proven	206.5	25.34	0.07	5.36	1.84	5,234	13.5	22,129	7,591	653
	Probable	226.0	28.84	0.06	4.80	2.50	6,518	13.8	21,678	11,319	713
	P+P	432.6	27.17	0.06	5.06	2.19	11,752	27.3	43,807	18,910	684
Terrible	Proven	0	0	0	0	0	-	-	-	-	0
	Probable	35.4	19.06	0.05	6.88	1.38	674	1.7	4,862	975	522
	P+P	35.4	19.06	0.05	6.88	1.38	674	1.7	4,862	975	522
Yellow Rose	Proven	44.1	20.48	0.05	4.26	2.34	904	2.3	3,762	2,068	834
	Probable	65.0	20.25	0.04	3.40	2.04	1,316	2.6	4,413	2,647	301
	P+P	109.1	20.34	0.05	3.75	2.16	2,220	4.9	8,174	4,714	517
All Areas Total	Proven	250.7	24.48	0.06	5.16	1.93	6,137	15.8	25,890	9,659	685
	Probable	326.4	26.07	0.06	4.74	2.29	8,508	18.1	30,953	14,941	610
	P+P	577.0	25.38	0.06	4.93	2.13	14,646	33.9	56,843	24,600	643

- Reserves are inclusive of Mineral Resources. All figures are rounded to reflect the relative accuracy of the estimates. Totals may not sum due to rounding. NSR listed here may be somewhat different than values calculated in the final economic model due to updated information at time of economic modeling.
- Mineral reserves are reported using a NSR CoG of \$391.73/st. The reserve estimate is based on a mine design using this cutoff with adjacent lower grade incremental stopes included in the design. Incremental material is included in the reserves based on an incremental stope cutoff grade of \$323.61/st.
- Metal price assumptions considered for the calculation of NSR are: Gold (US\$1,765/oz), Silver (US\$23.75/oz), Lead (US\$0.95/lb), and Zinc (US\$1.15/lb).
- Metallurgical recoveries for payable items in the Pb concentrate are: Gold (63.26%), Silver (93.44%), and Lead (93.78%). Metallurgical recoveries for payable items in the Zn concentrate are: Zinc (73.95%).
- Mineral reserves have been stated on the basis of a mine design, mine plan, and cash-flow model. Full mining recovery of designed areas is assumed.
- Mining dilution is applied at zero grade and ranges from 6.4% to 26.6%. A minimum mining width of 6 inches is used.
- The Mineral reserves were estimated by OSMI. Joanna Poeck, (BS Mining, MMSA, SME-RM) a Qualified Person, reviewed and audited the reserve estimates.

Source: SRK, 2022

1.7 Mining Methods

Geotechnical

SRK has conducted a geotechnical evaluation of the Project (SRK, 2016). Geotechnical core logging, structural mapping of drifts, and laboratory strength testing of drill core samples were used to characterize the mineralized rock and surrounding host rock. The characterization programs consisted of logging of 1,274 ft of core from drillholes located on the 2,000 ft level, drift face mapping from 30 stations in existing access drifts, laboratory strength testing of 38 historic and 20 new core samples. The new samples were tested by Agapito Associates in Grand Junction, Colorado. Because only a limited number of tests have been conducted to date, SRK has used the 33-percentile values for design purposes. Confidence in the assumed rock mass characterization values used in the design comes from observations of ground conditions in the accessible historic workings.

The Virginius Vein was divided into four structural-geotechnical domains: the hangingwall (HW), dike (Dk) including mineralized vein, footwall (FW), and the country rock of the San Juan formation (SJ). These domains were based primarily on the visible geologic structure near the vein, historic ground conditions, and the characterization data. The domains were used as the basis for developing the geotechnical design parameters. All of these domains are generally characterized as “Good” rock quality.

The stable open stope dimensions were estimated using the Potvin (2001) stability method. The size of open stope areas is 6 ft drift plus 6 ft resue slot with up to 6 ft wide vein and up to 1,000 ft long along vein strike. Stability estimates were also made for shrinkage stopes (only F-9 stope in current plan). Based on historic experience at the mine shrinkage stopes should remain stable. Ground support requirements were estimated using empirical support charts developed by Barton (1974).

Recent site visit has made observations of areas opened since the 2018 geotechnical study was conducted. SRK is of the opinion that the characterization reported in this report is still valid and the observations made in stoping areas confirm the characterization as applicable in the stoping areas.

Mining Methods

The reserves consider three of the many known veins within the Project - the Virginius, Terrible and Yellow Rose Veins. All are quartz veins containing silver, gold, copper, lead and zinc minerals hosted primarily in the San Juan volcanic rocks. Veins range from several inches up to several ft, and have been mined and drilled over a vertical extent of over 3,000 ft. The veins typically have dips around 70° but vary locally from approximately 50° to 85°.

The property has been historically mined since the late 1800's. A 300 st/d underground mill was constructed around 2013, though commercial production has not yet occurred. Based on the orientation and width of the mineralization, review of historic mining, and available geotechnical information, a resue mining method is appropriate where waste rock serves as backfill as the stope is advanced in an overhand manner. This method is highly selective and allows for mining narrow widths down to 0.5 ft. The mine has a significant amount of high-grade Ag ore carried in narrow vein structures.

Based on the NSR of the blocks in the resource model, large mining panels/stopes are manually identified in long section. The geologic vein shape is cut to the mining panels/stopes and tonnages/grades are reported for each stope. Stope dilution is calculated in the block model for each block, based on the specific block width, and is also reported to give an average dilution for the entire

stope. Tonnages/grades within a given stope are then diluted, based on the average dilution of that stope, in a spreadsheet. The average diluted grade of the entire stope panel is then compared to the CoG to ensure economic viability. A 3D design of the development required to mine the stopes was completed. Rehabilitation of existing workings is used when practical.

A stope block is identified having minimum approximate dimensions of approximately 500 to 1,000 ft along strike and up to 300 ft in height. Typically, an off-ore access drift is developed on the footwall along the length of the stope. Two-compartment raises known as cribbed manways, are developed on each end of the stope from the level below providing access to any level of the stope. In the center of the stope a three-compartment service raise with a manway, ore pass, and equipment slide is constructed as the primary access. Each raise will have utilities run up into the stope so that miners can pull water or air from either side of the stope or from the middle service raise.

The underground mine design process results in reserves of 577 kst (diluted) with an average grade of 25.38 oz/st Ag, 0.06 oz/st Au, 4.93% Pb, and 2.13% Zn. The overall NSR value for the reserve is US\$639/st. These tonnages and grades include only Proven and Probable material. Figure 1-1, the mine design colored by NSR.



Source: SRK

Figure 1-1: Mine Design Colored by NSR – Rotated View Looking Southwest (Looking from the Portal)

A monthly production schedule was generated using Excel for each development and stope item. This schedule was created by OSMI and SRK converted the line items and dates into an iGantt schedule to verify the scheduling order, required development and production tonnages/grades by period.

The schedule targeted approximately 8,000 st ore/month (96,000 st/y).

1.8 Recovery Methods

The processing plant will use conventional processing technologies of crushing, grinding, flotation, and concentrate dewatering to produce two separate lead and zinc concentrates. The plant will also produce a filtered tails product for dry stack tailing disposal. The concentrator facility has an annualized

design throughput of at least 91,390 st/y. The recovery of the lead and zinc concentrates will be performed by a traditional flotation process used to upgrade concentrate grades. The predicted recovery of lead and zinc are based on flotation testing completed by FLSmidth.

The ore from the mine will be transported by rail to a crushing circuit followed by a rod mill in open circuit and ball mill in closed circuit. Once the targeted liberation size of the particles from the ball mill slurry is reached, the slurry will be sent to the flotation circuit for concentration. The flotation circuit recovery and grade were improved from the installed flowsheet by the addition of new flotation capacity. The flotation circuit includes rougher, cleaner and final column stage flotation. This new flowsheet replaced the flowsheet proposed by Lycopodium during the 2016 PFS and eliminated the lead/copper flotation separation process, the regrind mill, and the online sample analysis system. The addition of concentrate thickeners improved the final concentrate capacity and feed delivery system to the filter press dewatering stage. Importantly, debottlenecking and design improvements including the addition of the Derrick screens and installation of a rod mill at the front end of the plant will increase performance in both consistency of feed and availability.

1.9 Project Infrastructure

1.9.1 Off-Site Infrastructure and Product Logistics

The existing and functioning Project off-site infrastructure includes access to the mine on existing improved roads and a warehouse/administrative facility located in Ouray. The area has significant developed infrastructure and is supported by the communities of Ouray and Ridgway with the combined population of both communities and the surrounding Ouray county of approximately 4,250. The City of Montrose (population >20,000), Colorado is within a 30-minute drive from Ouray and is expected to provide the bulk of housing for employees. These communities combined have experienced labor, supporting infrastructure and established businesses that have supported the mining industry in the area in the past.

The mine is located approximately 5.5 miles southwest of the town of Ouray and is accessed from U.S. Highway 550 near Ouray on Ouray County roads 361 and 26. The county roads are improved gravel that can be impacted by severe winter weather. The existing 15,000 square foot (ft²) off-site warehouse in Ouray houses administrative offices and includes a parking lot, laydown yard,

The mine will produce approximately 30 super sacks of concentrate per day that OSMI will transport from the mine to the Ouray warehouse for storage and shipping to the buyer's destination. For this study, transportation cost is based on transport to a delivery point in Mexico or Canada.

1.9.2 On-Site Infrastructure

The majority of the required Project infrastructure currently exists and has supported prior operations. Additional infrastructure was constructed during the preproduction period ending in December 2021 including a rail yard, expanded office and miners dry, dump wall repair, reagent storage building, and additional weather protection for outside facilities.

The existing surface facilities, as shown in Figure 1-2, include a tailings storage area, stockpile for low grade ore, administrative building and miner dry, mill building which also houses the tailings filters, laboratory and reagents and miscellaneous storage area. Other facilities not shown include a tailings thickener, rail system and car unloader, emergency generator, diesel storage tank, warehouse and shops. The site has several laydown and storage areas.

Tailings Storage Facility (TSF) — SRK has designed the filtered tailings piles within the existing permit boundaries to a height that can store the required storage capacity of the current FS Life-of-Mine (LoM) plan. The tailings have been tested for shear strengths and those values have been used in stability analyses to demonstrate that the factor of safety (FOS) is greater than the minimum 1.3 criteria. The availability of the two separate piles provides the operational flexibility to store tailings as conditions demand. The dry stack pile will provide storage for 574,965 st of filtered tailings and 222,469 st of waste rock, for a total of 797,434 st of combined waste and tailings. Tailings can be placed on the Revenue pile (eastern pile) during the summer months from May through November. The tailings need to be placed on the Atlas pile (western pile) during the winter months from December through April due to avalanche precautions. Construction on the Atlas winter storage area was completed in 2021. A final as built drawing will need to be developed once the snow melts and DRMS approval will be required before tailings can be placed in the Atlas TSF.

The Project has an existing permitted filtered tailings pile. A Tailings and Waste Management Plan of operations conducted by Greg Lewicki and Associates (Lewicki, 2015) and was submitted for the approved TSF permit. This work includes descriptions of the planned filtered tailings as received from the mill, compaction tests results and field compaction requirements, cold weather management plan, and ultimate planned pile configurations. Geotechnical laboratory testing was conducted by CTL Thompson (Thompson, 2015). Additional compaction and direct shear test were conducted on filtered tailings by IGES in Salt Lake City (IGES, 2017). Estimated material properties have been used to compute stability of the tailings stack using SLIDE program. The analysis results indicate a FOS of 2.17 under wet conditions. All cases analyzed have a FOS greater than the minimum 1.3 criteria.

A permit revision in the future will be required to modify the permitted 8.9 million cubic feet (Mft³) storage capacity after about five years of continuous production because more than 8.9 Mft³ of tailings will be produced. Since the revision is a volume revision only and is in the same footprint it does not impact the current permit boundary or disturbed area and therefore will be a Technical Revision which does not require public notice. SRK currently sees no reason such Technical Revision would not be granted.



Source: OSMI, 2016

Figure 1-2: Existing Surface Infrastructure

The underground infrastructure includes a portal, main access drift, #1 and #2 shafts, track haulage system, mine power system tied to the backup generator, mine ventilation system, emergency hoist and borehole, compressed air system, mine drainage ditches and pumps, and underground powder and primer magazines, communications systems (both surface and underground), and water supply pumps and sump.

The existing site infrastructure has been in place and functioning in the past during mine operations, most recently in 2015. In 2016, a passive water treatment system designed to capture mine discharge water was completed and fully permitted by OSMI. In 2021 the system was upgraded and is currently in operation.

The Project completed work to modify the existing facilities to further develop the Project. Primary surface and underground infrastructure additions included:

- Increasing backup generator size to 3 million watts (MW) to allow full operations to continue in the event that line power is interrupted during the winter and adding a facility to house the generator
- Improving and upgrading the current electrical system
- Expanding the existing administrative building and change house
- Covered railyard and warehouse facility at the mine portal

- Updating the surface crusher/screen system
- Rehabilitation of the run-arounds in the main haulage drift to allow sidings and create direct line transport of muck to the mill or waste dump wall
- Construction of a genset and transformer building
- Updating the compressed air system for both mine and mill with additional capacity and replacing supply lines
- Adding miscellaneous facilities to support warehousing, utilities and maintenance
- Updating the IT and communications systems for the mine site and warehouse

Future work that remains to be completed include the following key projects:

- Installing steel work and installing a hoist system at the #1 Alimak
- Replacing the emergency hoist in the Hubb-Reed raise with an elevator system, adding backup generation
- Updating the laboratory onsite and offsite laboratory adjacent to the warehouse in Ouray.
- A longer-term project that will begin but not be completed during the preproduction / ramp up phase is rehabilitation of the #1 Shaft and hoist

1.10 Environmental Studies and Permitting

Mining and mined land reclamation in the state of Colorado are declared necessary, proper, and compatible activities under the Colorado Mined Land Reclamation Act, Title 34 Article 32 of the Colorado Revised Statutes (CRS). The reclamation approvals and permitting for mine-related activities fall under the jurisdiction of the Mined Land Reclamation Board (the Board) and the Colorado Division of Reclamation, Mining and Safety (DRMS). The Project operates in accordance with the DRMS Section 112(d) Designated Mining Operation Permit Number M-2012-032.

The mine currently holds Colorado Discharge Permit System (CDPS) Permit No. CO-0000003, which authorizes surface water discharge from a five-stage passive mine water treatment system to Sneffels Creek via Outfall 002A. The Revenue Tunnel Portal discharges mine water through two 8-inch high-density polyethylene (HDPE) pipes to the passive mine water treatment system. In accordance with permit conditions, OSMI conducts bi-monthly and quarterly effluent sampling. The current CDPS permit expired August 31, 2018 and has been administratively continued by the Water Quality Control Division (WQCD) of the Colorado Department of Public Health and Environment (CDPHE) until its expected renewal in 2024.

On November 23, 2016, OSMI filed a Termination Application with WQCD for Outfall-001A. This termination followed OSMI's implementation of DRMS Permit TR-08 which requested the transfer of discharge to a bio-reactive treatment system with groundwater infiltration (effective September 8, 2016). This action eliminated the need for Outfall-001A. In June 2017, the WQCD denied the Termination Application and CDPHE and OSMI entered into a Compliance Order on Consent (COC) to resolve the matter. As part of the COC, CDPHE requested OSMI submit a Permit Modification application for Permit No CO-0000003 to modify certain aspects of the permit, including construction of an expanded five-stage passive water treatment system and addition of Outfall-002A. OSMI completed construction of the system modifications in May 2021. The treatment system achieved CDPS permit limits in November 2021 and in February 2022 CDPHE confirmed OSMI's performance under and closure of the COC.

The mine also maintains a CDPS General Permit for stormwater discharge (Certification No. COR-040289, former Permit No. CO-R040273). This permit requires a Storm Water Management Plan (SWMP) and routine inspections and annual reporting. OSMI updated the SWMP in November 2021.

The current reclamation bond for the Project is US\$517,219. All bonds are held by a fully funded certificate of deposit.

1.11 Capital and Operating Costs

The capital cost estimate is broken down by area including mining, processing plant, surface mobile equipment, infrastructure and engineering and construction contracts. Capital costs were developed by OSMI and Barr Engineering Co. (Barr) (process plant only). SRK reviewed the capital cost buildup and OSMI updated budgets. The capital costs are inclusive of applicable indirect costs. Contingency has not been included in the estimate due to the operational nature of the ongoing work.

Capitalized preproduction costs, including owner’s costs during the construction period, are included as operating and general and administrative (G&A) costs from the start of construction through the end of the three month ramp up period. The capital estimate is currently at a ±15% accuracy which is appropriate for a feasibility-level estimate. Costs are reflective of Q4 2021 and are US\$ based so foreign exchange conversion is not required.

The capital cost estimates are based primarily on quotations by vendors on materials, supplies, equipment, and installation. First principal buildups make up the remaining estimates. Current labor rates and inflationary impacts have been built into the OSMI budgets. Escalation has not been included in the estimate. Table 1-4 is a summary of the overall Project capital.

Table 1-4: Capital Cost Summary (US\$000’s)

Description	Pre-Production	Ramp Up	Total Initial Capital	Sustaining Capital	Total Capital
Revenue Mine	(\$608)	\$0	(\$608)	\$0	(\$608)
Revenue Mill	(\$152)	(\$524)	(\$676)	(\$625)	(\$1,301)
Surface	\$0	(\$280)	(\$280)	\$0	(\$280)
Site Infrastructure	(\$250)	(\$1,500)	(\$1,750)	\$0	(\$1,750)
Engineering & Construction Contracts	(\$1,669)	(\$1,200)	(\$2,869)	(\$2,800)	(\$5,669)
Subtotal	(\$2,678)	(\$3,504)	(\$6,183)	(\$3,425)	(\$9,608)
Pre-Production Costs ⁽¹⁾	(\$11,381)	\$0	(\$11,381)	\$0	(\$11,381)
Subtotal	(\$14,059)	(\$3,504)	(\$17,563)	(\$3,425)	(\$20,988)
Contingency	\$0	\$0	\$0	\$0	\$0
Total Capital	(\$14,059)	(\$3,504)	(\$17,563)	(\$3,425)	(\$20,988)
Operating Costs During Ramp Up		(\$7,933)	(\$7,933)		
Net Revenue During Ramp Up		\$5,770	\$5,770		
Total Net Capital and Start Up Costs	(\$14,059)	(\$5,667)	(\$19,725)		

Source: OSMI, 2021

The operating cost estimate is broken down by area including mining, processing, G&A, and surface operating costs. Operating costs were developed by OSMI based on previous FS parameters and updated with current pricing and information gained during the recent preproduction period. Labor rates represent the rates that OSMI paid to retain a quality work force. SRK reviewed the operating cost build up and basis of estimates for all areas. Contingency has not been included in the operating

cost estimate. The estimate is based on Q4 2021 pricing. The operating costs are in US\$ and no foreign currency conversion is required. No escalation has been included in the operating costs. The overall accuracy of the operating cost estimate is $\pm 15\%$ which is appropriate for a feasibility-level estimate.

The Project operating cost summary is presented in Table 1-5 and amounts to US\$251/st ore during the LoM.

Table 1-5: Operating Cost Summary

Revenue Mine Operating Costs	LoM		First 5 Years	
	US\$000s	US\$/t-RoM	US\$000s	US\$/t-RoM
Revenue Mining	\$100,799	\$175	\$88,450	\$187
Revenue Milling	\$34,653	\$60	\$28,392	\$60
Maintenance	\$13,130	\$23	\$11,199	\$24
G & A	\$50,621	\$88	\$38,365	\$81
Surface Operating Costs	\$20,220	\$35	\$16,816	\$36
Total Operating Costs	\$219,424	\$380	\$183,223	\$388

Source: OSML, 2018

1.12 Economic Analysis

The Project, as designed, will ship 41.1 kst of Pb concentrate and 16.7 kst of zinc concentrates over the current 75-month (approximately 6.25 years) reserve life. Production is forecast to be sold either to a trader or directly to a smelter, with multiple options available based on concentrate quality and volumes. The operation will produce recovered metal of 13.9 million ounces (Moz) silver, 23.1 thousand ounces (koz) gold, 2.5 million pounds of copper, 54 million pounds of lead and 23 million pounds of zinc.

With total capital expenditure over the life of the current reserve of US\$9.6 million and operating costs of US\$457.6/st ore, the Project will generate after-tax free cash flow of US\$126.3 million over its current 75-month reserve life, based on the flat commodity prices assumed herein. This results in an 8-month payback period, an after-tax net present value (NPV) 5% of US\$108.8 million and an after-tax internal rate of return (IRR) of 179%. Total production costs (inclusive of sustaining capital) are forecast to be US\$20.89/oz payable silver, excluding by-product credits. The NSR from Au, Cu, Pb, and Zn result in a by-product credit of US\$8.34/oz of payable silver, reducing the total production cost estimate to US\$12.55 per oz payable silver, on a byproduct basis. When calculated based on silver equivalent production, the total production cost is US\$15.48 per oz payable silver equivalent. Pre-tax and after-tax economic metrics are presented in Table 1-6.

Table 1-6: Pre-Tax and After-Tax Indicative Economic Results (US\$000's)

Revenue Allocation				
Payable Gross Revenue by Metal	Value	% of Gross		Wtd. Average Prices
Silver	312,223	74%	23.84	US\$/ozAg
Gold	36,662	9%	1,720	US\$/ozAu
Copper	2,414	1%	0.98	US\$/lbCu
Lead	49,471	12%	0.98	US\$/lbPb
Zinc	20,646	5%	1.34	US\$/lbZn
Total	421,417	100%		
Estimate of Cash Flow				
	Value	% of G.Rev.		
Total Gross Revenue	421,417	100%		
Smelting / Refining	(24,069)	-6%		
Freight / Insurance	(12,849)	-3%		
NSR Pre Royalty	384,500	91%		
Royalties	(7,690)	-2%		
Total Net Revenue	376,810	89%		
Total Operating Cost	(219,424)	-52%		
Operating Profit (EBITDA) Pre-tax Cash Flow	157,386	37%		
Total Tax	(10,063)	-2%		
After Tax Cash Flow	147,323	35%		
LoM Capital	(9,608)	-2%		
Pre-tax Undiscounted Free Cash Flow (US\$000)	136,398	32%		
After-tax Undiscounted Free Cash Flow (US\$000)	126,335	30%		
Discounted Cash Flow and Returns				
	After-Tax			
Undiscounted Free Cash Flow (US\$000)	\$126,335			
NPV US\$000 @ 5.0%	\$108,755			
IRR	178.72%			
Break Even Months	8			

Source: OSMI, 2022

1.13 Project Implementation

OSMI will be completing the remaining portion of the recent preproduction efforts to complete surface and underground projects to move the Project to full production. OSMI will self-perform the majority of all work identified and use the existing team and processes to complete the work. Engineering is already complete on the majority of the remaining tasks. The planned work will require eight months of preproduction effort with another three months of ramp up to production.

The program will include small projects on surface facilities, minor processing plant modifications, and a major effort in the underground mine. The key construction activities are as follows:

- Alimak #1 hoist installation including iron works. (UG)
- Development of the mining areas on the 1800, 1500, and 900 levels (UG)
- Miscellaneous surface projects as discussed in Chapter 18
- Additional Mill Upgrades and optimization

Plant commissioning has been done in multiple phases and additional commissioning and tuning will be required once the additional work is completed. Commissioning will be completed by OSMI employees with mechanical, electrical and instrumentation support from the contractors that installed the equipment. Vendor support will be arranged if necessary.

The plan details the steps to be taken in the recruiting and training process as well as the time frame associated with each. The objective of this plan is to ensure OSMI is hiring qualified candidates and that those candidates are properly trained for their specific job requirements, thereby ensuring a safe working environment and enhancing employee retention.

OSMI currently has a staff of 17 people and will ramp to 140 by month nine of the preproduction period of the Project. OSMI will add staff over the following eight months to reach full staffing of 150 employees. The 150-employee staffing will be maintained for the life of the mine under the current mine plan.

1.14 Conclusions and Recommendations

1.14.1 Property Description and Ownership

The Project is located in southwestern Colorado about 5.5 miles southwest of the town of Ouray. All of the mining claims are located in Township 43 North, Range 8 West, New Mexico Prime Meridian (NMPM), Ouray and San Miguel Counties, Colorado, and are held in the name of OSMI.

SRK have reviewed the current licenses in relation to the geological model and Mineral Resource, which SRK considers sufficient to cover the current estimated Mineral Resources.

1.14.2 Geology and Mineralization

SRK considers the current geological model to be reasonably well understood. Historical economic mining supports the potential for economic extraction. OSMI has completed sufficient geological work, both from historical logs and via underground mapping, drilling and sampling to have a detailed understanding of the current geological model.

During mining, understanding local variations will be important as the veins can show features relating to variable geometry, and erratic grade distribution (nugget effect), plus variations in internal architecture. Clear and accurate mapping of the local variations of mineralization features is essential. These features can include variations in dip, strike and width, late-stage faulting/shearing effects and vein continuity and type. Variations generally require close geological understanding to ensure optimum grade, minimal dilution and maximum mining recovery.

1.14.3 Status of Exploration, Development and Operations

In 2016 the Company has completed an additional 42 diamond core holes from underground within the northern portion of the Virginus Vein, as well as completed approximately 30 channel samples.

Drilling and channel sampling completed by OSMI during 2016 has been logged and sampled by senior OSMI geological staff. All samples have been submitted to Skyline labs for preparation and analysis using both fire assay and ICP methods. OSMI has included a Quality Assurance/Quality Control (QA/QC) program as part of the 2016 drilling campaign. While the dataset is limited in terms of population size, SRK considers the results to be within a reasonable level of error, and therefore acceptable for use in the MRE.

OSMI has also completed a validation study of the historical database, which included translating the historical descriptive drilling logs into a series of logging codes in the current database. The validation work has been extended to both diamond drilling and underground channel sampling.

SRK comments that the drilling below the 2000 level conducted by prior owners was conducted using AQ sized core which was the standard practice at that time. This may not be considered best practice under guidelines today. These areas are currently not accessible, but once open follow-up drilling to validate existing results should be completed.

Since 2016 the only additional drilling has focused on the northwest extension of the Virginius extensions to the northwest into the newly acquired license (Blue Grass), with limited underground exploration. In addition to the drilling OSMI completed a series of production samples during 2021 to support the initial production.

SRK reviewed the sampling information collected since the last 2017 model and noted the following in relation to the samples.

- There is a lack of independent QA/QC included in the current sampling protocols.
- The production sampling has been used to compare the performance of the 2017 model but has not been used in the current estimates due to the lack of QA/QC.
- Exploration drilling has been focused on the Blue Grass license to the northwest of the current operation, with initial intersections confirming the presence of the vein. Initial drilling results were not conclusive and follow up drilling will be done in the future. No mineral resources have yet been defined in this area.
- Based on this analysis SRK has elected to use the 2017 database and geological model for the basis of the current estimates, with a revised NSR (based on the latest assumptions), and depletions accounted for.

1.14.4 Mineral Resource Estimate

SRK has undertaken geological modelling to construct updated mineralization wireframes for the Virginius Vein system, Terrible Vein and the Yellow Rose Vein systems. SRK used the 3D solids created in Leapfrog to code the drillholes to differentiate between mineralization and waste and undertook statistical and geostatistical analyses on the composited data, as constrained by the modelled wireframes.

The Virginius Vein mineralization is typically associated with a dike unit and historically was coded as three separate vein codes. The revised interpretation simplifies the interpretation a single grade bearing structure and there remains opportunity that additional mineralization may exist to limited degrees where parallel structures are mineralized. It is SRK's opinion, this additional tonnage would have limited lateral and vertical extent, but good geological mapping and grade control sampling will improve the knowledge of continuity in these structures or minor splays of the main vein.

SRK has produced grade estimates using an ID2 algorithm, using a combined drilling and channel sampling database. To reduce the potential impact of localized high grades overly influencing the estimates, SRK has declustered the channel samples to 50 ft x 50 ft x 50 ft panels prior to estimation.

The classification is based on standards as defined by the CIM Definition Standards - For Mineral Resources and Mineral Reserves, prepared by the CIM Standing Committee on Reserve Definitions and adopted by CIM Council on May 14, 2014.

The Resources at the Project have been classified as Measured, Indicated and Inferred at Yellow Rose and Virginius Veins. The Terrible Vein has been limited to Indicated and Inferred, whereby

Indicated material is focused on diamond drilling completed by previous owners from surface. The current proposed mining method for the Project will result in all material within an established stope being mined, and therefore the direct application of a CoG on a block-by-block basis is not considered appropriate for the Project. SRK has accounted for the CoG during the classification of Indicated material, by working with OSMI staff on potential mining areas. Once an area has been identified SRK has analyzed the blocks based on the confidence criteria laid out in Section 14.9, and coding the model with the NSR value. Each area has then been evaluated to ensure the defined areas remain above the NSR CoG.

1.14.5 Recovery Methods

The following recommendations are made by Barr based on their experience with rod/ball mill circuits depending upon the results of initial operations, should issues arise:

- Evaluate media size for the rod mill, as different rod sizes could improve grinding efficiency (depending on feed size to the rod mill)
- Evaluate the opportunity to prescreen rod mill feed to bypass the fines to the 2nd stage of grinding to increase capacity of the rod mill

The following recommendations are made by SRK based on their December 2021 site visit during plant commissioning:

- OSMI should hire an experienced metallurgical engineer to provide technical and operational oversight of the concentrator.
- The deficiencies that have been identified in the concentrator should be corrected and the plant should be commissioned with demonstration that process design parameters can be fully achieved prior to initiation of commercial production. As part of this effort, the recommendations presented in Section 17-7 of this report should be implemented.

1.14.6 Project Infrastructure

The primary risks to the Project related to infrastructure include:

- Weather related issues including access and avalanche impact
- Power reliability that has been addressed by adding backup generation capacity
- Access to the emergency hoist at the surface for maintenance and upkeep has been addressed by changing the type of system and allowing access through the mine versus the access by mountain road to the previous system
- Water quality issues that have been addressed by the addition of water treatment facilities
- The access road is narrow and steep and winter conditions can impact access at times. The Project includes a budget for avalanche mitigation measures and a snow removal contract. Procedures are developed and in place to address these risks

The major infrastructure related items have been addressed. SRK makes no additional recommendations for additional work.

2 Introduction

2.1 Terms of Reference and Purpose of the Report

This report is prepared as a Technical Report for Ouray Silver Mines, Inc. (OSMI or Company) and Aurcana Silver Corporation (Aurcana) by SRK Consulting (U.S.), Inc. (SRK) and is based on a 2022 Revenue-Virginius Mine (the Project) FS.

This report is intended for use by OSMI and Aurcana subject to the terms and conditions of OSMI's contract with SRK. Any other uses of this report by any third party are at that party's sole risk. The responsibility for this disclosure remains with OSMI and/or Aurcana, as applicable.

The quality of information, conclusions and estimates contained herein is consistent with the level of effort involved in SRK's services, based on: i) information available at the time of preparation, ii) data supplied by outside sources, and iii) the assumptions, conditions, and qualifications set forth in this report.

This report provides Mineral Resource and Mineral Reserve estimates, and a classification of resources and reserves prepared in accordance with the Canadian Institute of Mining, Metallurgy and Petroleum Standards on Mineral Resources and Reserves: Definitions and Guidelines, May 10, 2014 (CIM, 2014).

2.2 Qualifications of Consultants

The Consultants preparing this technical report are specialists in the fields of geology, exploration, Mineral Resource and Mineral Reserve estimation and classification, underground mining, geotechnical, environmental, permitting, metallurgical testing, mineral processing, processing design, capital and operating cost estimation, and mineral economics.

None of the Consultants or any associates employed in the preparation of this report has any beneficial interest in OSMI or Aurcana. The Consultants are not insiders, associates, or affiliates of OSMI or Aurcana. The results of this Technical Report are not dependent upon any prior agreements concerning the conclusions to be reached, nor are there any undisclosed understandings concerning any future business dealings between OSMI and the Consultants nor Aurcana and the Consultants. The Consultants are being paid a fee for their work in accordance with normal professional consulting practice.

The following individuals, by virtue of their education, experience and professional association, are considered Qualified Persons (QP) as defined in the NI 43-101 standard, for this report, and are members in good standing of appropriate professional institutions. The QP's are responsible for specific sections as follows:

- Ben Parsons, MSc, MAusIMM (CP), Principal Consultant (Resource Geologist) is the QP responsible for Sections 4 through 12 and Section 14, 23, and portions of Sections 1, 25 and 26 summarized therefrom, of this Technical Report.
- Eric J. Olin, MSc Metallurgy, MBA, SME-RM, MAusIMM, SRK Principal Consultant (Metallurgy) is the QP responsible for Section 13, 17, 21.1.3, 21.2.4 and portions of Sections 1, 25 and 26 summarized therefrom, of this Technical Report.

- John Tinucci, PhD, PE, SRK Principal Consultant (Geotechnical Engineer) is the QP responsible for Section 16.2 and Section 18.3, and portions of Sections 1, 25 and 26 summarized therefrom, of this Technical Report.
- Jeff Osborn, BEng Mining, MMSAQP, SRK Principal Consultant (Mining Engineer) is the QP responsible Sections 2, 3, 16.5, 16.6, 16.8, 18 with the exception of 18.3, 19, 21 with the exception of 21.1.3 and 21.1.4, 22, 23, and 24 and portions of Sections 1, 25 and 26 summarized therefrom, of this Technical Report.
- Brian Prosser, PE, SRK Principal Consultant (Ventilation) is the QP responsible for Section 16.7, and portions of Sections 1, 25 and 26 summarized therefrom, of this Technical Report.
- Joanna Poeck, BEng Mining, SME-RM, MMSAQP, SRK Senior Consultant (Mining Engineer) is the QP responsible Sections 15 and Sections 16.1, 16.3 and 16.4, and portions of Sections 1, 25 and 26 summarized therefrom, of this Technical Report.
- Terry Braun, MSc, PE, Practice Leader/Principal Consultant (Civil Engineer) is the QP responsible for Environmental Studies, Permitting and Social/Community Impact Section 20, and portions of Sections 1, 25 and 26 summarized therefrom, of this Technical Report.

2.3 Details of Inspection

Details of site visits are shown in Table 2-1.

Table 2-1: Site Visit Participants

Personnel	Company	Expertise	Date(s) of Visit	Details of Inspection
Jeff Osborn	SRK	Mining	May 16, 2014 August 24, 2015 May 5, 2016 May 15, 2017 June 15, 2018 December 15, 2021	Each trip included an underground inspection and tour of surface facilities. The 8/24/2016 visit included inspection of surface emergency hoist.
Eric Olin	SRK	Metallurgy/Process	December 15, 2021	Tour of processing plant and surface facilities
John Tinucci	SRK	Geotechnical	May 16, 2014 August 24, 2015 December 15, 2021	Underground inspection and tour of surface facilities. Specific review of #1 shaft area.
Ben Parsons	SRK	Geology	August 24, 2015 October 19, 2015 June 20 to 22, 2016 February 21 to 24, 2017	Trip included Underground inspection, review drilling core, review historical records and database validation
Brian Prosser, PE	SRK	Ventilation	September 30 to October 1, 2015	Walked the entire mine (areas safe for access), measured airway resistances, examined the existing main fan, and developed a basic ventilation model

Source: SRK, 2021

2.4 Sources of Information

This report is based in part on internal OSMI technical reports, previous feasibility studies, maps, published government reports, company letters and memoranda, and public information as cited throughout this report and listed in the References Section 27.

2.5 Effective Date

The effective date of this report is December 31, 2021, which is the basis date for the update.

2.6 Units of Measure

The US System for weights and units has been used throughout this report except where noted. Tons are reported in short tons (st) of 2,000 lb except where noted as metric tonnes (mt) of 1,000 kilograms (kg). All currency is in U.S. dollars (US\$) unless otherwise stated.

3 Reliance on Other Experts

The Consultant's opinion contained herein is based on information provided to the Consultants by OSMI throughout the course of the investigations. SRK has relied upon information provided by OSM on their legal, environmental, and tax situations in the Project areas in support of this Technical Report.

SRK used their experience to determine if the information from previous reports was suitable for inclusion in this technical report and adjusted information that required amending. This report includes technical information, which required subsequent calculations to derive subtotals, totals and weighted averages. Such calculations inherently involve a degree of rounding and consequently introduce a margin of error. Where these occur, SRK does not consider them to be material.

These items have not been independently reviewed by SRK and SRK did not see an independent legal opinion of these items.

SRK

- SRK has not performed an independent verification of land title and tenure as summarized in Section 4 of this report. SRK did not verify the legality of any underlying agreements that may exist concerning the permits or other agreement between third parties but have fully relied on OSMI and its legal advisor for land title issues.
- SRK was informed by OSMI that there are no known litigations potentially affecting the Project.

4 Property Description and Location

4.1 Property Location

The Project is in southwestern Colorado approximately 5.5 mi southwest of the town of Ouray. The Revenue Tunnel, the site of the current surface activity, is located at longitude 107.750° W, latitude 37.974° N (mine grid coordinates of 100,630 ft E, 99,100 ft N). The majority of the historical underground work occurred approximately 1.2 mi to the southwest centered at approximately 107.773° W., latitude 37.967° N (mine grid coordinates of 97,790 ft E, 95,070 ft N). Figure 4-1 presents the location of the Project.

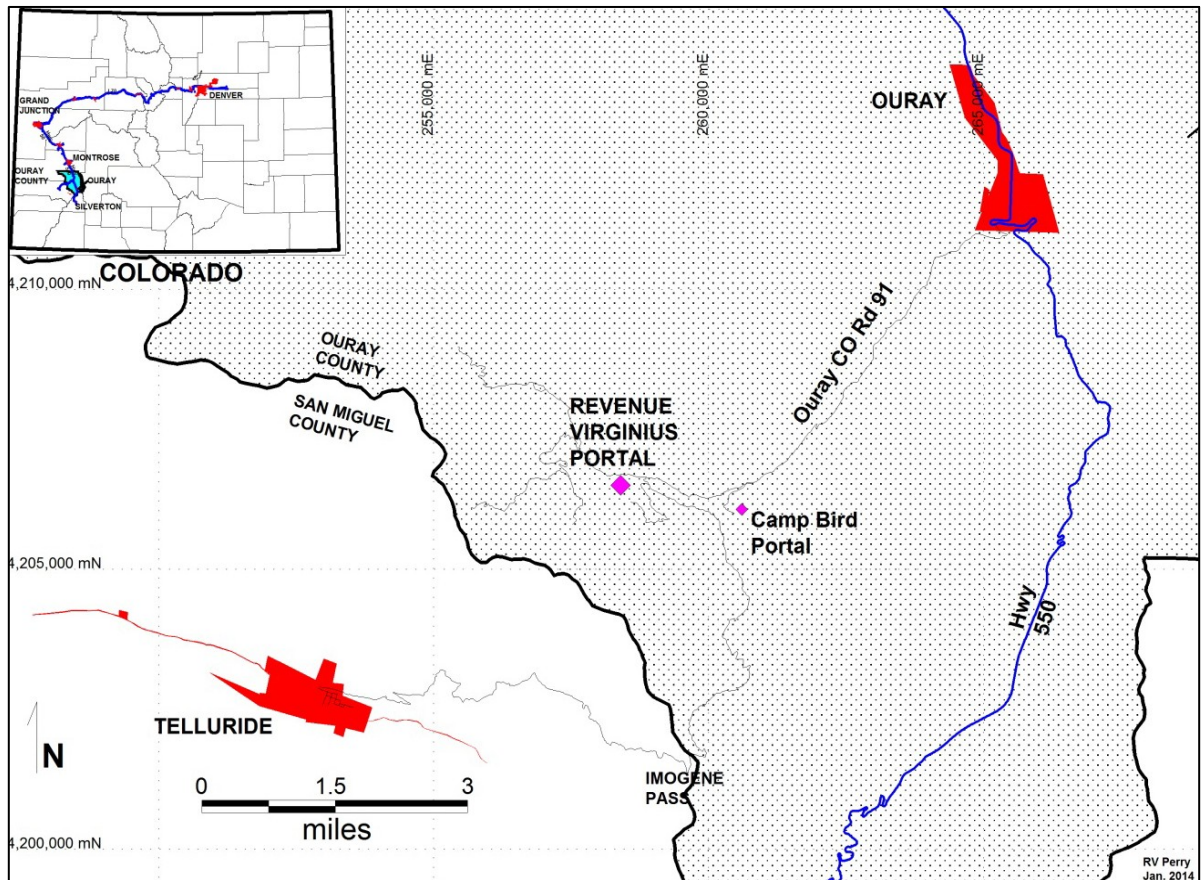

Source: Star Mines, 2013

Figure 4-1: Location Map

Figure 4-2 shows a generalized location map with drainage basins labeled, which are used as locators throughout this report.

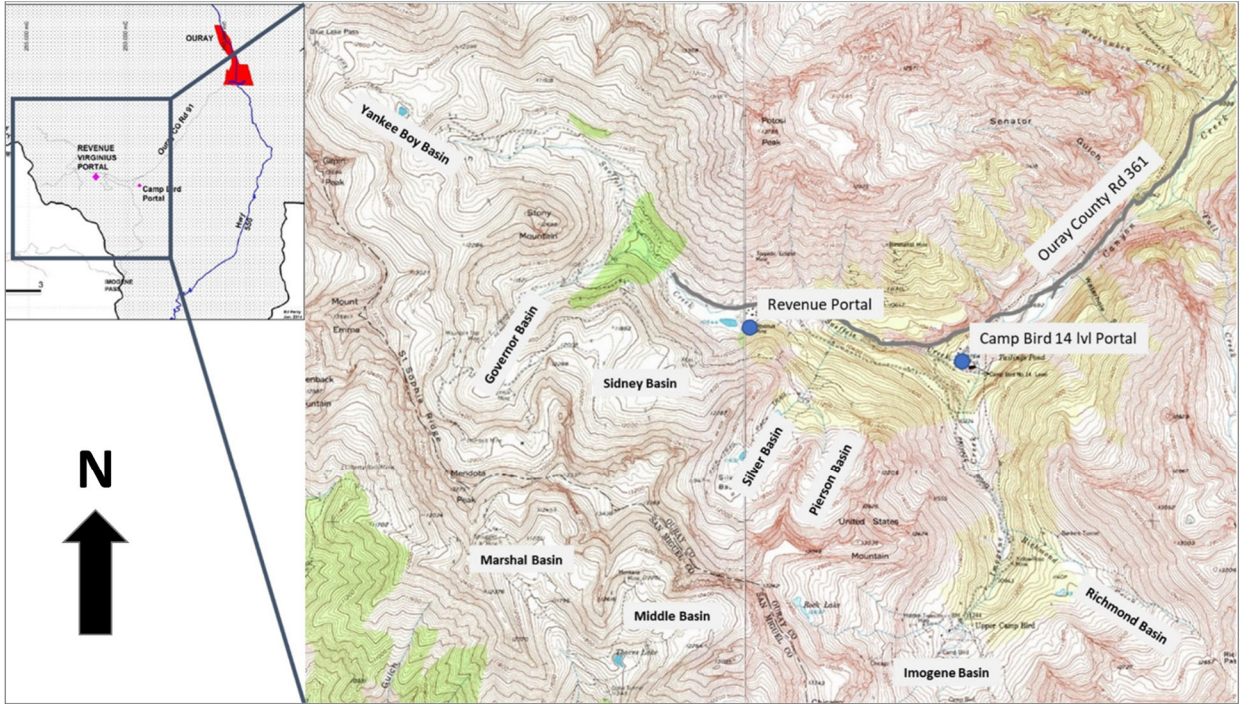

Source: OSMI, 2018

Figure 4-2: Location Map Showing Drainage Basins

4.2 Mineral Titles

Steven Lappin, Consulting Landman and Surveyor was contracted to compile the claim ownership in the vicinity of OSMI’s holdings in 2012 to 2014 under the previous (Star Mines) ownership. Since the inception of OSMI, holdings from previous owners have been merged into one land package. During 2015, as part of the assumption of ownership by LRC-FRSM II of OSMI, additional title work was completed by the law firm of Davis, Graham and Stubbs of Denver confirming existing patented and unpatented claim ownership.

OSMI currently contracts with Wolcott, a land services company, for digital storage, title work and evaluation of title of attractive target properties. In addition, OSMI continues to survey and replace claim corners on the ground each field season under contract with Monadnock Mineral Services which is a Registered Land Surveying Company. All claims controlling the apex of veins with Mineral Resources underlying them have been surveyed by a Registered Land Surveyor. Apex law is in effect in the State of Colorado.

In 2018 the property consisted of both patented and unpatented mining claims. There were 105 patented mining claims covering 768.69 net acres and 37 unpatented mining claims covering 342.98 net acres. Figure 4-3 shows OSMI’s current land package simplified for ease of viewing in this document. Table 4-1 and Table 4-2 show a detailed listing of the claims and includes the ownership interest in each claim.

On March 2, 2020, the Company announced the acquisition of the Blue Grass claim which lies along the strike extension of the Virginius North vein, adjacent to the Monongahela license. The Blue Grass claim has approximately 1,500 ft (457 m) of strike length of the high grade Virginius Vein mapped on

surface. In addition to the strike length contained in the Blue Grass, the Company's ownership of this important claim also provides access to on-vein development (underground) to over 6,000 feet (1,829 meters) of additional contiguous Virginius Vein strike length to the Northwest on claims already owned or controlled by the Company.

Source: OSMI, 2022

Figure 4-3: OSMI Claim Ownership

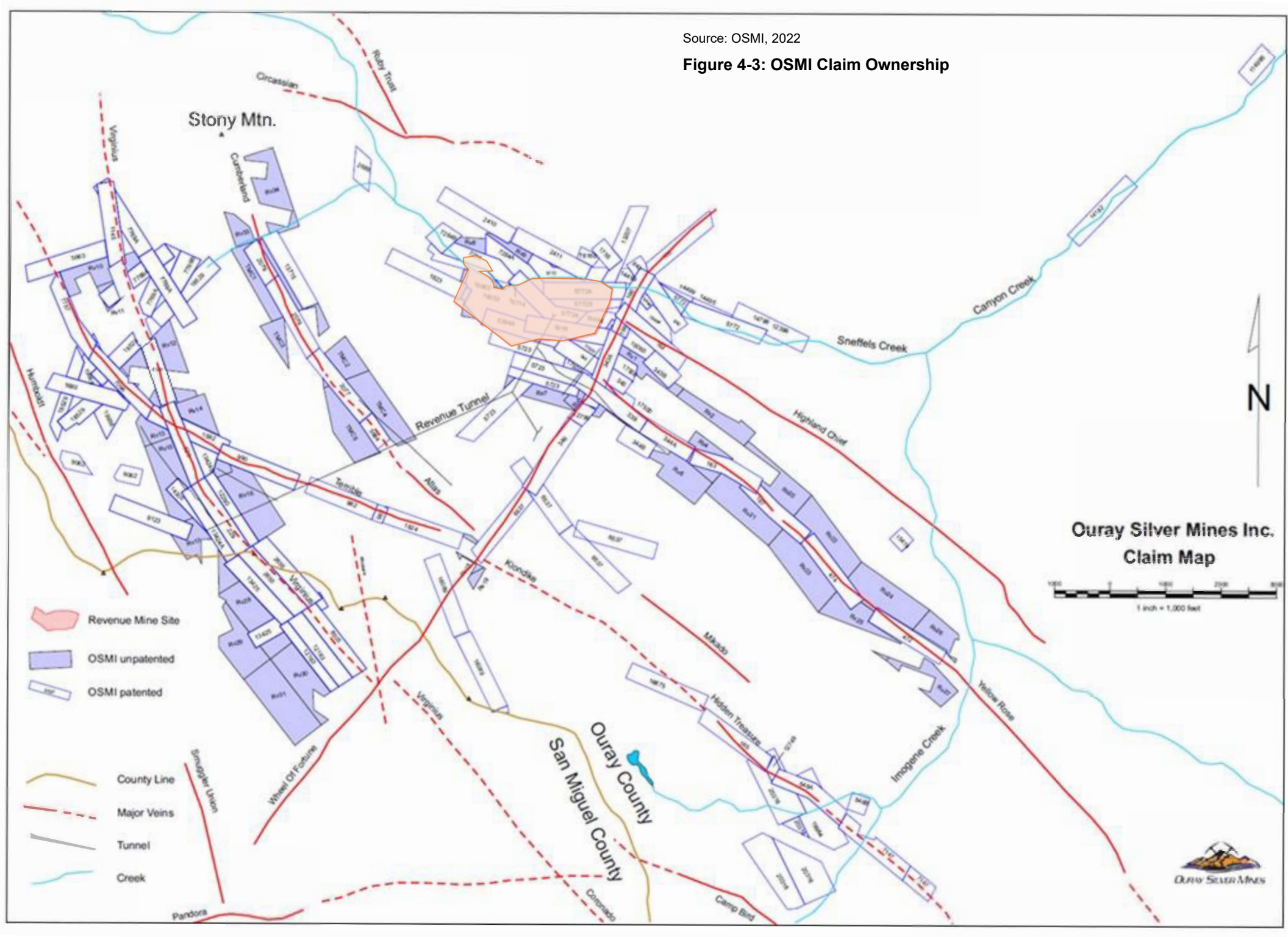

Table 4-1: Mining Claims Owned by OSMI

Patented Claim Name	Survey#	Date	Serial#	Acres	Interest	Vein Apex	County	Area/Basin	Royalty
Anglo Saxon	5723	10/29/1896	27539	3.89	100%		Ouray	Revenue	RVM Holdings
Atlas Ext.	5684	6/4/1895	25685	3.89	100%	Atlas - Cumberland	Ouray	Sidney	RVM Holdings
Banner	2079	6/3/1887	12114	5.11	100%	Atlas - Cumberland	Ouray	Governor	RVM Holdings
Bismark	2410	11/19/1889	15359	10.33	100%		Ouray	Revenue	RVM Holdings
Black	12290	5/28/1906	43625	6.40	100%		Ouray	Governor	RVM Holdings
Black Hawk	5723	10/29/1896	27539	8.93	100%		Ouray	Revenue	RVM Holdings
Blackstone	5019	4/20/1891	17668	10.29	100%		Ouray	Revenue	RVM Holdings
Blaine	5772 A	6/18/1894	24478	9.41	100%		Ouray	Revenue	RVM Holdings
Blank	17500	10/20/1906	44556	7.03	100%		Ouray	Revenue	RVM Holdings
Blank Millsite	14495	4/17/1902	35357	5.00	100%		Ouray	Revenue	RVM Holdings
Blazer	16494	11/6/1905	41106	5.77	100%		Ouray	Revenue	RVM Holdings
Blazer Millsite	14499	4/17/1902	35358	0.86	100%		Ouray	Revenue	RVM Holdings
Block	12163	2/1/1899	30502	10.33	100%		San Miguel	Governor	RVM Holdings
Blue Grass	459			8.23	100%		Ouray	Governor	
Blythe Lode	18529	7/8/1909	71065	6.71	93.75%		Ouray	Governor	
Boojum	16089	6/8/1907	44192	7.76	100%		Ouray	Silver	RVM Holdings
Caribou	163	1/14/1879	3032	9.10	100%	Yellow Rose	Ouray	Revenue	RVM Holdings
Chief Deposit	167	1/14/1879	TBD	10.07	100%	Yellow Rose	Ouray	Revenue	
Chip	12163	2/1/1899	30502	5.62	100%		San Miguel	Governor	RVM Holdings
Clara Belle	6537	4/23/1892	20807	8.27	100%	WOF	Ouray	Silver	RVM Holdings
Clipper #2 Lode	7769 A	10/17/1893	23467	6.71	93.75%		Ouray	Governor	
Col. Porter	5772 A	6/18/1894	24478	4.29	100%		Ouray	Revenue	RVM Holdings
Cruller	12163			10.33					
Cumberland	2077	2/25/1887	11594	10.33	100%	Atlas - Cumberland	Ouray	Sidney	RVM Holdings
Doughtnut	12163			5.62					
Eclipse Millsite	7816 B	12/4/1893	23690	2.25	100%		Ouray	Revenue	RVM Holdings
Egypt Placer	16053	7/21/1904	39362	17.84	100%		Ouray	Revenue	RVM Holdings
Eliza Pinkstone	12799	2/6/1900	32135	2.61	100%	WOF	Ouray	Revenue	RVM Holdings
Engle	8505	7/5/1894	24552	10.31	100%	Virginius	San Miguel	Governor	RVM Holdings
Fargo Lode	18529	7/8/1909	71065	5.41	93.75%		Ouray	Governor	
Grand Trunk	339	3/17/1884	8927	7.88	100%	WOF / Yellow Rose	Ouray	Revenue	RVM Holdings
Grant	7284 A	12/4/1893	23689	7.41	100%		Ouray	Revenue	RVM Holdings
Gray Eagle Lode	5663	8/10/1891	18413	10.19	93.75%	Terrible	Ouray	Governor	
Ground Hog	16675	7/21/1906	TBD	10.31	49.58%	Hidden Treasure	Ouray	Imogene	
Hard Cash	5394 A	7/3/1896	27239	7.69	100%		Ouray	Revenue	RVM Holdings
Hendricks Lode	7769 A	10/17/1893	23467	6.15	93.75%		Ouray	Governor	
Highland Lassie	162	1/14/1879	3030	10.22	100%	WOF / Highland Chief	Ouray	Revenue	RVM Holdings
Hill Top	13424 A	6/2/1904	38905	1.97	100%		Ouray	Governor	RVM Holdings
Hill Top Millsite	13424 B	6/2/1904	38905	3.77	100%		Ouray	Governor	RVM Holdings
Last Chance Millsite	11499	11/16/1898	30063	0.00	0%		Ouray	Misc.	
Lincoln	7284 A	12/4/1893	23689	7.36	100%		Ouray	Revenue	RVM Holdings
Lincoln Millsite	7284 B	12/4/1893	23689	4.22	100%		Ouray	Revenue	RVM Holdings
Link	11535			8.73	873%				
Little Annie Lode	2688	11/19/1890	16810	3.49	93.75%		Ouray	Misc.	
Little Chief	840	6/15/1883	7783	8.35	100%		Ouray	Revenue	RVM Holdings
Lizard	2655	4/8/1890	15976	10.19	100%		Ouray + San Miguel	Governor	RVM Holdings
Mark Twain	344 A	7/30/1881	4870	6.83	100%	Yellow Rose	Ouray	Revenue	RVM Holdings
Mark Twain Millsite	344 B	7/30/1881	4870	5.00	100%		Ouray	Revenue	RVM Holdings
Mikado	6537	4/23/1892	20807	10.20	100%		Ouray	Silver	RVM Holdings
Millionaire	472	10/31/1882	TBD	10.09	80.00%	Yellow Rose	Ouray	Revenue	
Moltke	2411	6/19/1889	15052	10.30	100%		Ouray	Revenue	RVM Holdings
Monarch	990	5/31/1883	7766	10.02	100%	Terrible	Ouray	Governor	RVM Holdings
Monetizer	346	7/30/1881	4872	10.33	100%	WOF	Ouray	Silver	RVM Holdings
Monongahela	523	5/12/1884	9218	10.03	100%	Virginius	Ouray	Governor	RVM Holdings
Mountain Queen Lode	7757	10/17/1893	23466	7.95	93.75%	Terrible	Ouray	Governor	
Mountain Top	13425	6/2/1904	34291	9.38	100%		San Miguel	Governor	RVM Holdings
Muldoon	14798	7/1/1903	36783	9.08	100%		Ouray	Revenue	RVM Holdings
Myrtle	5723	10/29/1896	27539	5.26	100%		Ouray	Revenue	RVM Holdings
Nada	2655	4/8/1890	15976	10.19	100%	Virginius	Ouray + San Miguel	Governor	RVM Holdings
Nashville	2078	2/25/1887	11595	10.18	100%	Atlas - Cumberland	Ouray	Governor	RVM Holdings
Nuada Lode	18529	7/8/1909	71065	2.41	93.75%		Ouray	Governor	
Old Trail Lode	7769 A	10/17/1893	23467	5.10	93.75%		Ouray	Governor	
Ottawa	5772 A	6/18/1894	24478	7.29	100%		Ouray	Revenue	RVM Holdings
Pocahontas	165	1/14/1879	TBD	10.09	16.50%	Hidden Treasure	Ouray	Imogene	RVM Holdings
Potosi	168	1/14/1879	3037	8.93	100%	WOF	Ouray	Revenue	RVM Holdings
Protector	16494	11/6/1905	41106	5.04	100%		Ouray	Revenue	RVM Holdings
Ptarmigan	12749	4/20/1901	TBD	1.36	62.08%	Hidden Treasure	Ouray	Imogene	
Queenie	1824	8/9/1887	12378	9.90	100%	Terrible	Ouray	Silver	RVM Holdings
Rene Lode	18529	7/8/1909	71065	5.81	93.75%	Virginius	Ouray	Governor	
Revenue	5723	10/29/1896	27539	8.60	100%		Ouray	Revenue	RVM Holdings
Revenue Millsite	16714	5/16/1905	41995	0.05	100%		Ouray	Revenue	RVM Holdings
Saracen NW 300'	15474	4/9/1904	TBD	2.06	80.00%		Ouray	Imogene	
Sarah Bernhardt	6537	4/23/1892	20807	9.94	100%	WOF	Ouray	Silver	RVM Holdings
Seven Thirty	166	1/14/1879	3035	6.50	100%	WOF	Ouray	Revenue	RVM Holdings
Shamrock Lode	1145	6/4/1889	14995	10.11	93.75%	Virginius	Ouray	Governor	RVM Holdings
Sidney (E 200 ft.)	982	10/4/1883	8250	1.38	100%	Terrible	Ouray	Sidney	RVM Holdings
Sidney (W portion)	982	10/4/1883	8250	8.95	100%		Ouray	Sidney	
Silver Dollar Lode	13715	2/18/1904	38033	10.19	93.75%		Ouray	Governor	
Silver Queen	345	7/30/1881	4873	8.22	100%		Ouray	Revenue	RVM Holdings
SiWash Millsite	16965	4/3/1905	41996	0.40	100%		Ouray	Revenue	RVM Holdings
Slide	14182	1/16/1902	34898	10.33	100%		Ouray	Misc.	
Snark	16089	6/8/1907	44192	5.46	100%	WOF	Ouray	Silver	RVM Holdings
Stonewall Jackson	5772 A	6/18/1894	24478	10.16	100%		Ouray	Revenue	RVM Holdings
Stonewall Jackson MS	5772 B	6/18/1894	24478	5.00	100%		Ouray	Revenue	RVM Holdings
Summit	13207	4/20/1901	33766	6.77	100%		Ouray	Misc.	RVM Holdings
Terrible	1592	12/9/1886	11299	7.37	100%	Terrible	Ouray	Governor	RVM Holdings
Terrible #2 Lode	7096	8/3/1892	21721	9.12	93.75%	Terrible	Ouray	Governor	
Thomas J. Regan Lode	19958	1/8/1921	13484	6.74	93.75%		Ouray	Governor	
Tip Top	9062	7/8/1895	25817	7.96	100%		Ouray	Governor	
Tip Top	13425	8/2/1901	34291	10.33	100%	Virginius	San Miguel	Marshall	RVM Holdings

Patented Claim Name	Survey#	Date	Serial#	Acres	Interest	Vein Apex	County	Area/Basin	Royalty
Tornado Lode	1680	10/23/1886	11092	10.13	93.75%		Ouray	Governor	
Torpedo (SE 500 ft)	1755	4/8/1887	11813	3.44	33.00%		Ouray	Misc.	RVM Holdings
Two Step	17500	10/20/1906	44556	5.05	100%		Ouray	Revenue	RVM Holdings
US Depository	474	7/18/1889	TBD	10.28	80.00%	Yellow Rose	Ouray	Revenue	
Valkyrie	14305	6/20/1904	TBD	8.01	90.00%		Ouray	Governor	
Valley View	1823	5/7/1894	24291	10.33	100%		Ouray	Revenue	RVM Holdings
Victor	6537	4/23/1892	20807	9.86	100%		Ouray	Silver	RVM Holdings
Virginius Lode	229	5/12/1880	3956	10.33	100%	Virginius	Ouray	Governor	RVM Holdings
Volta	5772 A	6/18/1894	24478	6.25	100%		Ouray	Revenue	RVM Holdings
Walrus	16089	6/8/1907	44192	1.11	100%		Ouray	Misc.	RVM Holdings
Wheel of Fortune	343 A	7/30/1881	4871	9.68	100%	WOF	Ouray	Revenue	RVM Holdings
Wheel of Fortune MS	343 B	7/30/1881	4871	4.10	100%		Ouray	Revenue	RVM Holdings
White Pine	9123	8/19/1896	25890	10.33	100%		Ouray	Governor	
Ymir	16494	11/6/1905	41106	1.42	100%		Ouray	Revenue	RVM Holdings
Zig Zag Lode	7769 A	10/17/1893	23467	10.33	93.75%		Ouray	Governor	
Zig Zag Millsite	7769 B	10/17/1893	23467	5.00	93.75%		Ouray	Governor	
Total Acres				768.69					

Source: OSMI, 2022

Table 4-2: Unpatented Mining Claims

Claim Name	BLM Serial #	Location Date	Gross Acres	Section	Net Acres	County
T.M.C. No 1	CMC281857	9/2/2011	20.42	20	10.67	Ouray
T.M.C. No 2	CMC281858	9/2/2011	20.42	20	9.14	Ouray
T.M.C. No 3	CMC281859	9/2/2011	20.42	20	5.06	Ouray
T.M.C. No 4	CMC281860	9/2/2011	20.42	20, 21	13.74	Ouray
T.M.C. No 5	CMC281861	9/2/2011	20.42	20, 21	12.95	Ouray
RV 1	CMC282292	10/4/2011	20.66	21, 22	4.31	Ouray
RV 2	CMC282293	10/4/2011	20.66	21, 22	8.56	Ouray
RV 4	CMC284135	7/13/2012	20.66	21, 22	4.69	Ouray
RV 5	CMC282295	10/5/2011	20.66	21	2.89	Ouray
RV 6	CMC282296	10/5/2011	20.66	21, 22	12.46	Ouray
RV 7	CMC282297	10/5/2011	20.66	21	5.07	Ouray
RV 8	CMC284136	7/14/2012	20.66	21	2.56	Ouray
RV 9	CMC284137	7/13/2012	20.66	21	3.02	Ouray
RV 10	CMC284138	7/17/2012	20.66	19,20	8.80	Ouray
RV 11	CMC284139	7/17/2012	20.66	20	1.88	Ouray
RV 12	CMC284140	7/17/2012	20.66	20	8.82	Ouray
RV 13	CMC284141	7/17/2012	20.66	20	6.56	Ouray
RV 14	CMC284142	7/17/2012	20.66	20	8.36	Ouray
RV 15	CMC284143	7/17/2012	20.66	20,29	13.24	Ouray
RV 16	CMC284144	7/18/2012	20.66	20,29	17.23	Ouray
RV 17	CMC284145	7/18/2012	20.66	20,29	8.52	San Miguel
RV 18	CMC284146	7/21/2012	20.66	21,28	1.37	Ouray
RV 19	CMC284147	7/22/2012	11.02	28	1.18	Ouray
RV 20	CMC284148	8/1/2012	20.66	22,27	9.87	Ouray
RV 21	CMC284149	7/30/2012	20.66	22,27	15.10	Ouray
RV 22	CMC284150	7/29/2012	20.15	22,27	13.80	Ouray
RV 23	CMC284151	7/29/2012	20.15	27	16.41	Ouray
RV 24	CMC284152	7/30/2012	20.58	27	17.37	Ouray
RV 25	CMC284153	7/30/2012	20.58	27	9.05	Ouray
RV 26	CMC284154	7/30/2012	20.66	26,27	7.58	Ouray
RV 27	CMC284155	7/30/2012	20.66	26,27	7.14	Ouray
RV 28	CMC284156	8/2/2012	20.66	29	12.72	San Miguel
RV 29	CMC284157	8/2/2012	20.66	29	12.87	San Miguel
RV 30	CMC284158	8/2/2012	20.66	29	13.02	San Miguel
RV 31	CMC284159	8/2/2012	20.66	29	20.66	San Miguel
RV 33	CMC285304	7/2/2013	20.66	17,20	3.60	Ouray
RV 34	CMC285305	7/2/2013	20.66	17,20	12.71	Ouray
Total Acres					342.98	

Source: OSMI, 2022

4.2.1 Nature and Extent of Issuer’s Interest

The mining claims, Revenue Tunnel, all mining equipment, surface equipment and buildings, milling equipment and operations located on these claims are owned and controlled by OSMI. As part of Colorado state laws for any mining claim application, a company is required to supply a large-scale claim map, in addition to a sketch or narrative describing the claim boundaries and the relationships to neighboring claims or landmarks, which effectively defines whether a claim is considered the senior claim or a junior claim. This can be explained in more detail by assuming two adjacent claims with intersecting veins. The Senior claim has rights to follow the extension of the main structure (vein) being mined on its own claim into a neighbor’s claim, and vice versa for any minor veins being mined on the junior claim. In a situation where at the intersections of the veins there is significant mineralization, then it is the Senior Claims right to mine that area, even if located on the juniors claim.

Patented claims grant both fee simple ownership of the surface of the land and all underlying minerals. Unpatented mining claims grant ownership to the underlying minerals and permit use of the surface for activities and infrastructure required to exploit the underlying minerals.

Owners of patented mining claims are required to pay annual county property taxes to hold the land and beyond payment of taxes, ownership is in perpetuity. Unpatented mining claims grant provisional ownership of the underlying minerals and to maintain this ownership annual fees of US\$155 per claim are due the U.S. Bureau of Land Management (BLM) by September 1st of each year. OSMI records an affidavit of payment of the BLM claim fee with the Clerk and Records office of Ouray County and has done so since 2017, and the next payment is due in Q3 2022. This is not a legal requirement, but the fee for recording is US\$6 for the first page, US\$5 for each additional page and US\$0.25 for each claim name paid to Ouray County.

4.2.2 Claim Location and Access

The claims covering the Yellow Rose Vein zone are accessible on surface from County Road 26C (Silver Basin Road). Surface accesses to the claims covering the Virginus and Terrible Veins are along County Roads 26A, X, W and V (Governor Basin Road).

The Revenue Tunnel is a historical access tunnel with a deeded tunnel easement that passes through OSMI claims as well as other claims held by private/corporate ownership and the U.S. Forest Service (USFS). The USFS manages surface activities on unpatented claims and not mineral rights.

4.3 Royalties

A royalty on approximately 79 claims was established in the Stock Purchase agreement between RVM Holdings and Silver Star Resources on September 21, 2011. The royalty applies to production from certain patented claims of the property. The agreement covenants that the owner of the property is not obligated to explore, develop, or produce from the property, all decisions regarding the property are in the sole discretion of the owner, and no interest shall be due on the royalty. There are no other obligations of the owner related to the royalty.

The agreement calls for a 2% NSR royalty up to a total payment of US\$9 million paid out of production. After the US\$9 million for royalty has been paid, and if the price of silver is greater than US\$60/oz, a NSR royalty of 1% will be due on continuing production up to a total payout of a second US\$9 million. Table 4-1 shows the claims for which this RVM Holdings production royalty is payable.

4.4 Environmental Liabilities and Permitting

4.4.1 Environmental Liabilities

The current environmental liabilities include reclamation and closure of the existing surface infrastructure (e.g., buildings, portal, surface water management), waste rock stockpiles the Atlas TSF, and Revenue Pond TSF. The current reclamation bond required by DRMS is US\$517,219. Three additional bonds are also required for current operations with the first for US\$7,826.61 with DRMS for drilling under a Notice of Intent to Explore. The second from DRMS for drilling in Governor Basin for US\$3,526. The third bond for US\$5,000 is required by Ouray County for winter maintenance activities conducted by OSMI on County Road 361. All bonds are held by a fully funded certificate of deposit. The Atlas TSF is also an ongoing liability.

4.4.2 Required Permits and Status

OSMI maintains the required environmental permits for re-start of mine and milling operations. Plans for re-start involve Amendment 02 to the primary mining permit (No. M2012032) administered by the DRMS. Amendment 02 served to increase the permit boundary as well as incorporate obligations made up through Technical Revision 16. Section 20.1 provides a summary of the required permits and current status for re-start of operations.

5 Accessibility, Climate, Local Resources, Infrastructure and Physiography

5.1 Topography, Elevation and Vegetation

The Project is in southwestern Colorado near the town of Ouray, in Ouray County. Ouray is approximately 335 highway mi or approximately 5.5 hours by road southwest of Denver via Interstate 70 and US Highways 50, 550 and 285.

The San Juan Mountains in general, and the Project area in particular, are rugged young volcanic mountains with steep topography. Glacial valleys form the broadest areas of relatively flat ground but are typically surrounded by steep walls. Within the Project area, elevations range from about 10,000 ft to nearly 13,500 ft.

The Revenue portal site is developed on a large flat area of broken waste rock from the construction of the Revenue Tunnel. The surface buildings and infrastructure are located at the mouth of the Revenue Tunnel. A dry stack tailing facility (DSTF) and a further expansion is co-located with the other surface facilities. The mill is located underground near the Revenue portal area and is connected to the Revenue Tunnel via underground workings.

Vegetation on the property is typical of Sub-alpine areas of the southern Rocky Mountains. North facing slopes are typically covered by evergreen trees while south facing slopes are drier and have plants requiring less moisture.

5.2 Accessibility and Transportation to the Property

To access the property from Ouray, follow County Road (CR) 361 southwest up Canyon Creek past the Camp Bird Mine. The portal of the Revenue Tunnel is 6.7 mi from the beginning of CR 361 on the south side of Sneffels Creek. Current surface activity is at the Revenue portal (Figure 4-1). Additional property access information can be found in Section 18.

During the summer months, the property is accessible by high clearance two-wheel-drive vehicles. During the winter, four-wheel-drive vehicles are required since the road is snow covered.

5.3 Climate

There are no officially published weather/climate records for the Project. The nearest information is for Ouray located at an elevation of approximately 7,800 ft, which is about 2,860 ft lower than the Revenue portal at 10,660 ft. The Köppen Climate Classification subtype for Ouray is "Dfb - "Warm Summer Continental Climate". The average temperature for the year in Ouray is 44.3°F. The warmest month, on average, is July with an average temperature of 64.7°F. The coolest month, on average, is January with an average temperature of 25.8°F. The highest recorded temperature in Ouray is 96.0°F in June and the lowest recorded temperature was -22.0°F in January.

Average annual precipitation for Ouray is 23.1 inches. March is the wettest month with 2.3 inches of precipitation falling as snow while June is the driest with 1.1 inches of precipitation. Average annual snowfall is 140.2 inches.

The portal area and mine surface infrastructure are located at an elevation of 10,660 ft. The portal and surface facilities lie just below a north facing slope at the base of Sydney Basin and on the south side

of Sneffels Creek in a steep-walled valley approximately 1,000 ft below timberline. The area near the portal is classified as Sub-alpine, but the higher elevation of the property are in the Alpine climate zone. The Project area experiences broad temperature swings both within and between seasons. During winter months, temperatures hover near freezing on warmer days to well below 0°F on cold days and nights. During summer, temperatures vary from the 50's°F to modestly below freezing on cooler nights to the upper 70's°F and low 80's°F on very warm days. Anecdotal information suggests that the average temperature at the portal is typically 15°F cooler and winter snowfall perhaps double that falling in Ouray.

The Project is accessible year-around although heavy winter snow in the area requires plowing from about November through May along with avalanche mitigation to maintain year-round mining operations. The road up to the Revenue portal is maintained by OSMI year-round under permit with Ouray County and the US Forest Service. During winter months, OSMI is permitted to close the road to all but emergency traffic at Senator Gulch which is located approximately halfway to the mine on County Road 361. During summer months the mine maintains the road along with the County. The Project has avalanche controls in place during the winter months and currently contracts with Helitrax, a local avalanche forecasting, and mitigation company based in Telluride. During the summer months, thunderstorms are frequent and can be severe with lightning and heavy rainfall that can cause flash flooding in the streams.

5.4 Sufficiency of Surface Rights

Since the area is located on patented mining claims owned and controlled by OSMI, certain permitting activities are simplified. The mineral deposits are located at variable distances to the southeast of the portal and accessed from the Revenue Tunnel.

5.5 Infrastructure Availability and Sources

The Project was operated previously and has well developed power, water supply and access to skilled miners. The site has a developed tailings storage area and plant site as well as developed access. The details of the infrastructure are discussed in Sections 17 and 18.

OSMI owns, operates and maintains the following water and land rights for the Revenue-Virginus Mine:

- Revenue-Virginus Mine Works, 3.34 cfs (1,500 gpm)
- Lake Reservoir, 27.74 acre-feet of water

The original decree for the Revenue-Virginus Mine Works was issued on June 26, 1979, by the Colorado State District Court Water Division No. 4, Case No. W-2993. The point of diversion is located within the NE ¼ SE ¼ of Section 21, Township 43 North, Range 8 West of the NMPM. The source of the water rights is located within Sneffels Creek, a tributary of the Uncompahgre River. The Revenue-Virginus Mine Works for mining, milling and industrial purposes has a recorded appropriation date of 1934. Commercial, piscatorial, recreational, fire protection and domestic purposes were decreed as of December 30, 1976. The decreed municipal rights were cancelled on December 8, 1987, in Case No. 87CW110.

The original decree for Lake Reservoir was issued on April 10, 1979, by the Colorado State District Court Water Division No. 4, Case No. W-2991. This is an absolute decree. The water rights equal 27.74-acre feet of water for storage. Lake Reservoir is described as being located in accordance with

a map and statements No. 5049 filed with the State Engineer on August 20, 1908. Point of discharge is located at a point whence Corner Number 3 of Survey Number 1318B, Mt. Sneffels Mill Site bears North 57° East, 295 ft in Section 21, Township 43 North, Range 8 West of the NMPM. The Lake Reservoir for water storage right for domestic, fire protection, mining, milling and power purposes has a recorded appropriation date of 1905.

6 History

6.1 Prior Ownership and Ownership Changes

The following text and Table 6-1 summarize the history of the Project and, unless otherwise noted, is taken substantially from an internal report by Steve Zahony (2013) and from an internal memorandum written by Sunshine Mining and Refining Company (Sunshine) on the property dated January 12, 2001.

The history of the Project is well documented by past reports and historical essays and books. Table 6-1 is a summary outline of the property's mining history and lists key individuals involved at various times. The property has had two owners from 1886 until the purchase by FRSM. A.E. Reynolds was the principal owner of the Caroline Mining Co. and its successor companies, and his heirs remained the owners of the property until its purchase by Star Mines in 2011 (Zahony, 2013).

After the outcrop discovery of the Virginius Vein in 1876 and its near-surface development, the property was purchased in 1880 and developed by the Caroline Mining Company under the direction of A. E. Reynolds. The earliest work occurred at high elevations in Governor Basin and mostly from the 3rd Level portal. The 3rd Level became the primary access to the vein and development of the mine progressed downward through a 1,100 ft internal shaft from the 3rd Level to the 14th Level (Zahony, 2013).

When logistics and costs became too challenging to continue mining from the 3rd Level and Virginius Shaft, the Revenue Tunnel was driven between 1888 and 1893 to access the Virginius Vein at depth. The Revenue Tunnel Company spent nearly five years driving the Revenue Tunnel. The Tunnel intersected several veins en route to the Virginius Vein and these became targets for varying levels of exploration and production. Among these was the Cumberland-Atlas Vein system, which was mined during this period. When miners reached the Virginius structure in the Revenue Tunnel, they encountered a strong eastern or footwall structure of the vein, and later a western or main structure. They drifted on the main structure to the southeast for over 5,000 ft, to beyond where the Virginius Vein intersected the Montana Vein system (Zahony, 2013).

Caroline Mines operated the mine for its most productive period from 1880 to 1901. Several setbacks resulted in limited production beyond 1901. In 1906, a fire in the upper workings caused electrical damage and failure resulting in flooding on levels below the Revenue Level. The following year the Revenue mill burned. Production after the mill fire was limited to small scale mining and some exploration (Zahony, 2013).

After A. E. Reynolds' death in 1921, the property was managed by his daughter and son-in-law. Work during this period included modest development work over the next several years including the construction of a small 10 st/d ball mill and limited stoping (Zahony, 2013).

In 1923, the northwest extension drift on the Terrible Vein was channel sampled along its length on approximately 6 ft centers. The average sample width was thought to be 2 ft. No economic mineralization was located at that time, but the results showed silver values of ranging from <1 oz/st and up to 50 oz/st and variable gold values ranging from 0.01 to 0.76 oz/st and averaging in the range of 0.05 to 0.06 oz/st Au. No distinct shoots of higher-grade vein material were identified on the main level and these grades have not been confirmed through modern sampling. Other work included the development of an approximate 200 ft raise and limited drifting along vein at the top of the raise. Channel sampling the raise and associated levels near the end of the northwest-trending drift above

the Revenue Level did not identify economic mineralization at the time but higher grades than those found on the tunnel level were reported.

In 1938, the family of A.E. Reynolds contracted geologist George Garrey to direct development of the Project. Garrey assumed management of the family's mining assets including the Project. He wrote multiple reports on the Project's veins and their exploration potential. These reports formed the basis for the modern exploration of the Revenue property by Camp Bird Colorado, Inc. (Federal Resources), Ranchers Exploration and Development Corp. (Ranchers), and Sunshine.

According to Garrey (1947), pre-1922 production from the Cumberland was US\$153,590, with an additional US\$16,862 having been mined by lessees from 1922 to 1926. Of the 12,000 st mined before 1922, 4,200 st were hand-cobbed and shipped, averaging 0.136 oz/st Au, 28.5 oz/st Ag, and 25.5% Pb.

Between 1948 and 1953, there was work on the Wheel of Fortune Vein. The Wheel of Fortune Vein was intersected by several long drifts that followed veins crossing the Revenue Tunnel to the southeast. Intersections between the Yellow Rose, Anglo-Saxon, Cumberland, and Virginus Veins failed to find economic mineralization within the Wheel of Fortune structure at the Revenue Tunnel Level, and the Wheel of Fortune was not historically mined in these areas (Zahony, 2013).

Production from Wheel of Fortune Vein was limited but reportedly "high grade", most of it coming from a single mineralized shoot that was mined on three levels over a vertical extent of 400 ft immediately above the main adit level. This principal level consists of a drift along the Wheel of Fortune Vein with a portal on the southwest slope of Sneffels Creek's valley at an elevation of 10,680 ft. The drift is 1,730 ft long, following the vein in a southwesterly direction extending through its intersection with the Yellow Rose Vein and beyond for another 450 ft from that intersection. The single mineralized shoot on the Wheel of Fortune claim was discovered cropping out at the surface and was worked down following the northeasterly rake of the shoot to just above the long main drift level that was driven below the stope. Production from the shoot was high in silver but the shoot narrowed with depth. The long drift encountered no economic mineralization though several shallow experimental stopes were attempted. Towards the northeast from the portal, in the opposite direction from the drift and across Sneffels Creek, the trace of the Wheel of Fortune Vein is followed by the Potosi patented claim. Beyond the Potosi claim, the Wheel of Fortune structure appears to continue further to the northeast with the rising surface slope to the Bimetallic Mine, whose portal is at an elevation of 11,475 ft. Production at this mine was high grade silver-gold mineralized material, but the Bimetallic Mine is outside the present Project boundaries.

Federal Resources leased the property in 1960 and in their five-year lease period drove over 3,440 ft of headings, mostly to the north of the Virginus Shaft No.1 on both the Revenue Tunnel and the 210 Levels. This also included work in the Cumberland Vein workings and the Belcoe Raise. Camp Bird work included channel sampling, experimental mining and test milling at the Camp Bird milling facility.

The most complete and usable exploration and development information on the Project was generated by Ranchers between 1980 and 1984 when Ranchers spent US\$8.5 million in exploration and was committed to take the property to production. However, Ranchers' hard-rock mining assets were purchased by Hecla Mining in mid-1984 and Hecla shut down the Revenue Project.

Sunshine leased the Project in 1994 and between that date and the termination of its lease in 2001, spent an additional US\$1.2 million in its study of the Virginus and Yellow Rose Veins, rehabilitation of

the portal, and in exploratory surface drilling of other veins. Sunshine built on earlier Ranchers' work to construct a modern digital database of all previous channel sampling and drilling and created a 3D digital model of the underground workings. They also expended considerable effort toward estimating and frequently updating "reserves" on the property (Zahony, 2013).

Star Mines acquired the Project in 2011 from RV through a combination of a stock purchases of the RV dated September 21, 2011, and closed June 25, 2012. Star Mines expanded the Project with further land acquisitions. Star Mines conducted exploration including drilling and channel sampling in both the Virginus and the Yellow Rose between 2012 and 2013. This work in part supports the resource estimates reported in this Technical Report and are discussed in Sections 9 and 10 of this report.

On May 8, 2014, Fortune Revenue obtained a 12% interest in the Project and operating authority for the mine, mill and surface operations via its wholly owned subsidiary FRSM. On October 1, 2014, FRSM acquired the balance of 100% ownership of the mine through an asset purchase agreement supported by senior secured financing (the "PFA") from Lascaux Resource Capital Fund I LP (LRC) via LRC-FRSM, LLC (LRC-FRSM). FML was the guarantor on the PFA. After default on the PFA, on July 17, 2015, FML and LRC-FRSM, LLC entered a Master Restructuring Agreement. As part of the MRA, 100% ownership of FRSM transferred to LRC-FRSM II, LLC, also held 100% by LRC. On July 21, 2015, FRSM changed its name to OSMI. OSMI currently owns and operates the site.

On December 27, 2018, Aurcana completed a reverse takeover transaction pursuant to a plan of arrangement under the CBCA (the "Arrangement") with OSMI, which holds the "Revenue-Virginus Mine" located in Colorado, pursuant to an arrangement agreement dated September 20, 2018, between the Company and LRC-FRSM LLC and LRC-FRSM II LLC (collectively, the "LRC Group"). Under the Arrangement, Aurcana acquired all of the issued and outstanding shares of common stock of OSMI from the LRC Group on a debt free basis in exchange for newly issued common shares of Aurcana.

On March 31, 2020, pursuant to a definitive agreement between OSMI and Caldera Mineral Resources ("Caldera"), the Company closed the acquisition of the Blue Grass claim located on the Virginus Vein contiguous to the Revenue-Virginus Mine. In return, Caldera received certain non-core claims of the Revenue-Virginus Mine from OSMI. The swap of mineral properties has been considered a non-monetary transaction for which the fair value of the asset received was not reliably measurable. As a result, the original carrying value of the properties given up by the Company has been allocated to the Blue Grass claim acquired from Caldera. Upon the completion of the swap, Blue Grass claim became a part of the Revenue-Virginus Mine.

A summary of the history is shown in Table 6-1.

Table 6-1: Ownership and Exploration History of the Virginus Vein and the Revenue Tunnel

Date	Ownership	Company	Activity	Persons Involved	Core Holes
1876 to 1880	Family of A.E Reynolds	Individuals	Virginus Vein discovered at 12,700 ft, accessed via upper two levels.	WB Feland, Alvord & Chase	
1880		Caroline Mining Co	Virginus claims purchased by AE Reynolds.	AE Reynolds	
1880 to 1906		Caroline Mining Co and Glacier Mining Co	3rd Level driven at 12,420 ft elevation and Virginus UG Shaft sunk from 3rd level to 14th Level. Vein stoped 14 th Level to 3 rd level.	AE Reynolds	
1888 to 1893		Revenue Tunnel Co	Drive the 8 ft x9 ft Revenue Tunnel for 7,500 ft	AE Reynolds	
1894 to 1906		Revenue Tunnel Co and Caroline Mining Co	Production from above the Revenue Tunnel Level and below the Tunnel Level down to the 350 Level. New stamp mill at the portal in 1895.	AE Reynolds, HW Reed manager 1880-1901, EH Platt	
1906		Revenue Tunnel Co	Fire in upper workings caused electrical failure and subsequent flooding of all levels below the Revenue Level.	AE Reynolds, H Krumb, PG Caetani, EH Platt, AG Suydam	
1907 to 1922		Lessee	Revenue mill burns 1912, H Krumb takes 228 channel samples of Virginus Vein on the Tunnel Level.		
1916 to 1918		Revenue Tunnel Co	Drifting on 14 th level of Virginus Vein exposes +650 ft of milling mineralized material but no mill available.		
1921			AE Reynolds dies. Daughter Ann R Morse and husband Bradish Morse take control.	Morse and Morse	
1922 to 1923		Sneffels Leasing Co	Stoping on Cumberland Vein under Atlas Extension patented claim on Revenue Level.	JW Clamp, TH Woods	
1932		Lessee	Build 10 st/d ball mill and gravity table.	WB Rogers	
1934 to 1938		Revenue Development Co	Rehab work, develop Belcoe Raise up 200 ft on Cumberland Vein from Revenue Level, milled some Cumberland dump at 0.04 oz/st Au, 4.6 oz/st Ag, 5% Pb.	JW Belcoe, GA Franz	
1943 to 1945		King Lease	Drift 150 ft on +200 level of Cumberland Vein, sink Cutler winze 100 ft, and repair Revenue Tunnel.	LK Requa, RG Lee, RS Dunn	
1946 to 1948		Virginus Mines Co	Rehab Virginus Vein drift and Revenue Tunnel. Recondition Shaft No 1 to -350 level, 210 level extended SE 146', Cutler winze on Cumberland deepened to 146'.	DC McNaughton, WSJ	
1948 to 1953		Revenue Mines	Atlas drift extended 1,428 ft from Revenue Tunnel, two fatalities in Atlas drift, work on Wheel of Fortune Vein.	MC Dann	
1960 to 1970		Camp Bird (Federal Resources)	Drove NW and test mined the Monongahela section of the Revenue Vein on the Revenue Level and drove 116 ft NW on the -210 level. Most underground work completed in 1966.	CP Tremlet, JDS	DDH-1 to DDH-6, DDH-M-1 to DDEH-m-6
1966		Revenue Virginus Mines Co	Progress report by C Melbye to JH Tippit - RV Mining Co.	C Melbye, JH Tippit	
1947 to 1976		Revenue Virginus Mines Co	Project summary and projected operation report by CP Tremlet.		
1980 to 1984		Ranchers Exploration and Development Corp	Rehab Revenue Tunnel, rehab Shaft No. 1 to 700 level, drift south along vein on 550 level, UG drilling from 550 level on Virginus Vein and on Yellow Rose Vein, experimental stoping up from 210 level to the Revenue Level.	RA Larson, Project Mgr, JR Trujillo, Geologist, DJ Fitch, RE Lyons	RV-1 to RV-85, FF-1 to FF-152, YR-1 to YR-36, Y-1 to Y-24, T-1, TT-1 to TT-43, TF-1 to TF-9, BG-1 to BG-2,

Date	Ownership	Company	Activity	Persons Involved	Core Holes
					M-1 to M-2, HC-1 to HC-5
1984 to 1985		Hecla Mining Co	Hecla purchased mining assets of Ranchers, reviewed the RV project and elected to drop it.		
1994-2001		Sunshine Mining and Refining Co	Explored project, drilled underground, enhanced the digital database including the 3D digital model, and calculated a reserve.	Alan Young, VP, JR Trujillo, Geologist	MK-1, MK-2, SQ-1, SQ-2, T-2, T-3, YR37 to YR-46, WF-1 to WF-3
2011	Star	Star Mine Operations LLC	Property is purchased by Star Mining Operations from Virginius Mines Corporation owned by the heirs of A.E. Reynolds.	Rory Williams, JR Trujillo, Jim Williams	
2012 to May 8, 2014		Star Mine Operations LLC	Star buys project, drills on Virginius and Yellow Rose Veins, builds 300 st/d underground mill, and develops veins for production.	Rory Williams Jim Williams	YR-47 to YR-66, Y-25 to Y-50, WOF-1 to WOF-7, TR-1 to TR-16, MT-1 to MT-10
May 2014 to July 17, 2015	Fortune Revenue	Fortune Revenue Silver Mines Inc.	FRSM obtains a 12% interest in the Project as well as operating authority for the mine, mill and surface operations. FRSM completes 100% acquisition of the assets and commences production targeting 400 st/d mill throughput.	Robin Goad CEO Mike Romaniuk COO	
July 17, 2015 to December 27, 2018	OSMI	OSMI	OSMI takes ownership of 100% of the Project. It retrenches operations, revises the operating strategy and completes a PFS in 2016 and FS in 2017 including drilling, metallurgy and process design. In 2018 the FS is updated to refresh capital and operating cost estimates to current bids. On December 27, 2018, Aurcana completed a reverse takeover transaction pursuant to a plan of arrangement under the CBCA (the "Arrangement") with OSMI	Brian Briggs CEO	OSM-001-OSM-042
December 27, 2018 to Present	OSMI	Aurcana	Aurcana continued pre-production activities, raises debt and equity financing and restarts operations.	Kevin Drover CEO	

Source: Zahony, 2013; Modified by SRK, 2014; Modified by OSMI, 2022

6.2 Exploration and Development Results of Previous Owners

The exploration completed by previous owners is detailed in Section 9 of this report.

6.3 Historic Production

Historical production records by Perry (2013) showed varying detail in historical recordkeeping. The majority of the production from the mine occurred between its discovery in 1876 and the flooding and fires that occurred in 1906 and 1912. Specific production records for the period 1876 to 1895 are not available. A. E. Reynolds' heirs believe that many of these early records had been stored at the mill and were destroyed in the 1912 fire. However, this was a very productive period in the mine's history and involved all or most of the production from the surface to the 14 Level of the mine. The longitudinal sections of the Revenue Vein show the major extent of this productive period.

In 1976, Tremlett compiled production records from 1895 to 1906. His records begin roughly when the Revenue Tunnel would have reached the Virginus Vein and probably represent production between the Revenue Tunnel and the 14 Level and from the Revenue Tunnel level down to the 550 Level. Table 6-2 is modified from Tremlett (1976). It is a summary of production for the 12-year period between 1895 and 1906 and documents approximately 10.1 Moz of silver production. It is estimated that approximately 204,000 st were milled. Between 1901 and 1906, the average grade of the product sold was 14.89 oz/st Ag, 0.083 oz/st Au and 4.38% Pb. The 10.1 Moz of silver reported by Tremlett (1976) does not include pre-1895 production or the more modest production from 1907 through about 1920.

Table 6-2: Historical Production from the Project as Reported by Tremlett in 1976 modified by R. Perry (2013)

Year	Tons Mined (st)	Tons Milled (st)	Tons Shipped Crude + Conc.	Tonnes of Total Conc. Sold	Ag oz Sold	Au oz Sold	Pb lb Sold
1895 to 1900							
1895			5,556		751,823	2,419	3,176,000
1896			9,346		1,167,657	2,613	4,914,400
1897			11,992		1,685,916	3,181	6,565,600
1898			11,452		1,676,371	4,952	6,799,200
1899			10,663		1,477,502	5,399	5,659,600
1900			8,254		1,174,668	6,466	4,984,800
Totals 1895 to 1900		203,778	57,263		7,933,937	25,030	32,099,600
1901 to 1906							
1901	62,008	60,095	1,313	4,933	889,378	5,846	3,871,303
1902	44,347	Incomplete records					
1903	33,382	Incomplete records					
1904	8,506	8,344	162	1,175	111,788	774	956,721
1905	33,665	32,539	1,126	4,364	533,295	2,318	3,824,784
1906	42,336	39,693	2,643	4,352	647,903	3,160	4,170,616
Totals 1901 to 1906	162,236	141,271	5,244 (20,068 reported)	14,824	2,182,344	12,098	12,823,424
Total 1907 to 1912	unknown	unknown	122,223		14,529,368	123,515	63,320,823
Totals 1895 to 1912			199,553		24,645,639	159,642	108,243,847

Source: Tremlett (1976) modified by OSMI (2017)

7 Geological Setting and Mineralization

7.1 Regional Geology

The San Juan Mountains are the erosional remnants of a large Tertiary volcanic field covering roughly 9,500 square miles (mi²) in southwestern Colorado. The volcanic field is reported to contain fifteen defined and two buried calderas (Steven and Lipman, 1976). The older pre-caldera volcanic rocks, thought to have formed 35 to 30 Ma ago, consisted of intermediate, predominantly andesitic, flows and flow breccias. About 30 Ma ago, the eruptive character became more explosive, depositing rocks of intermediate to more felsic composition. The character of the volcanism changed again at about 28 Ma to a bi-modal suite of basaltic and rhyolitic rocks with the largest volume of felsic rocks consisting of the Sapinero Mesa Tuff, which was erupted from the San Juan and Uncompahgre calderas.

Most relevant to the Project are the nearby San Juan-Uncompahgre, Silverton and Lake City Calderas shown in Figure 7-1. These lie to the east of the Project. The San Juan-Uncompahgre Caldera is a large northeast-aligned volcanic depression consisting of the earlier Uncompahgre and San Juan Calderas, which in turn host the younger Lake City Caldera in its northeast portion and the Silverton Caldera at its southwestern segment. Steven and Lipman (1976) are of the opinion that the Silverton/San Juan/Lake City/Uncompahgre Caldera system is unique in the San Juan Mountains in that it displays the best-developed radial/concentric fracture system of any of the calderas in the San Juan Mountains. Steven and Lipman (1976) speculate that this complex and strong faulting are likely the control for the vein systems in the San Juan Mountains.

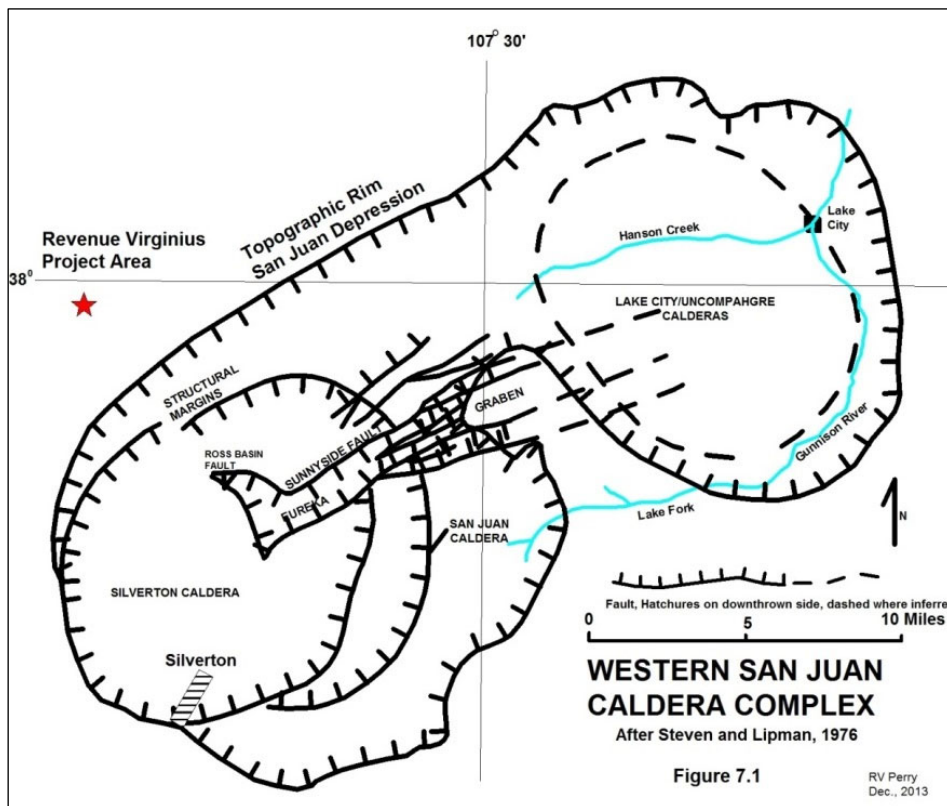

Source: Perry, 2013; modified from Steven and Lipman, 1976

Figure 7-1: Western San Juan Caldera Complex

7.2 Local Geology

The dominant rock formation in the Project area is the 35 to 30 Ma andesitic San Juan Formation. This is a thick package of mostly water-lain volcanoclastic rocks with minor lava flows. These rocks are in turn overlain by younger (30 to 28 Ma) ash flows of the Ute Ridge and Blue Mesa Tuffs. Volcanism in the Project area is interpreted to have begun approximately 28.4 to 26.37 Ma ago related to eruptions in the Uncompahgre and San Juan Calderas. This resulted in the deposition of the Dillon Mesa and Sapinero Mesa Tuffs. Subsequent doming and collapse resulted in the development of the Silverton Caldera and in deposition of the Crystal Lake Tuff approximately 26.7 Ma.

Based on stratigraphic relations, Burbank and Luedke (1966) believe that the Stony Mountain/Sneffels intrusive complex was forming contemporaneously with collapse of the Silverton caldera although K-Ar age dating by Lipman and others (1976) yields ages for these intrusives of about 32 Ma, indicating they had been active for some time prior to development of the Silverton Caldera.

The veins of the Sneffels district seem to occupy structures that were genetically related to the San Juan and Silverton Calderas, they are radial and concentric structures extending for several miles northwest of the actual caldera margin. These structures were apparently influenced by the contemporaneous emplacement of the Stony Mountain Stock as evidenced by their propensity to merge with the radial pattern of faulting surrounding the Stony Mountain Stock (Figure 7-2).

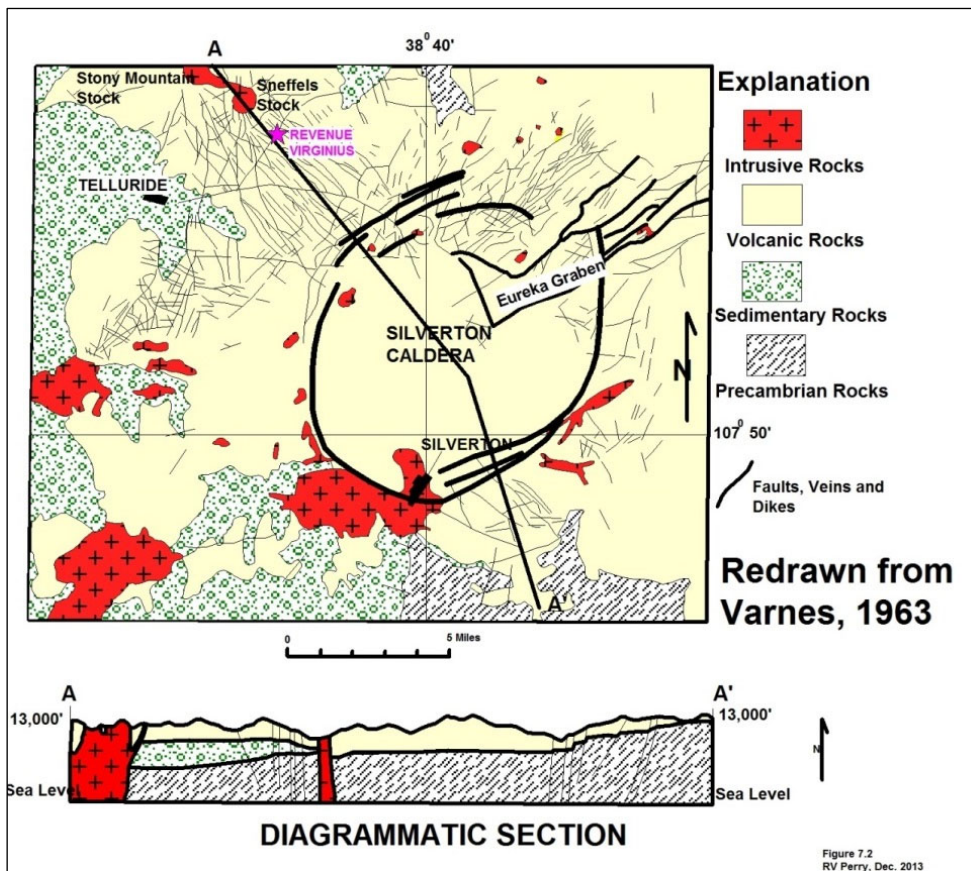

Source: Perry, 2013; modified from Varnes, 1963

Figure 7-2: Generalized Geologic Map of the Silverton / Ouray / Telluride Area

7.3 Project Geology

There are several formations exposed within the Project area but not all are exposed in the underground workings of the mine. Table 7-1 is a summary of the rock units, which, within the area of the mine, span a vertical thickness of nearly 3,500 ft.

Table 7-1: Stratigraphic Column for Rocks Exposed in the Project Area

Series	Formation	Description
Oligocene	Gilpin Peak Tuff (Tertiary Paleogene [Tpg]) (4 mebers) 28.4 Ma	Tpg-5 (Dillon Mesa tuff), 80'
		Tpg-4, 32'
		Tpg-3, (Blue Mesa Tuff) 325'
		Tpg-1 (Ute Ridge Tuff), 490'
	Burns Formation	Dark, massive flows, flow breccias, and tuffs of predominantly rhyodacitic composition 0 to 230 ft thick
Eureka Member, Sapinero Mesa Tuff	Medium to dark, rhyodacitic to quartz-latite, welded ash-flow tuff with abundant lithic inclusions, 0 to 200 ft thick	
Picayune Formation	Dark, porphyritic and amygdaloidal flows, breccias and tuffs of andesitic to rhyodacitic composition 50 to 100 ft thick	
San Juan Formation 35 to 30 Ma	Primarily andesite to rhyodacite mudflow breccias with sparse interbedded andesite flows, 2,000 to 2,600 ft thick	
Eocene	Telluride Conglomerate	Reddish-gray to red-brown conglomerate with interbedded sandstone, siltstone and shale, 0 to 520 ft thick

Source: Burbank and Luedke, 1966 and Lipman, et al., 1973

Although extensively exposed at surface in the area, the Burns Formation is not recognized within the workings of the Project. It is believed that the unit pinches out short of its intersection with the workings. Below is a discussion of each of the formations, oldest to youngest, found in the Project.

Telluride Conglomerate

The Eocene Telluride Conglomerate is located in the Project area and while not actually exposed in the current mine, it has been identified in drilling completed by Ranchers approximately 100 ft below the bottom of the No 1 Shaft (700 Level) at about 800 ft below the Revenue Level.

The Telluride Conglomerate lies unconformably on an erosional platform consisting of rocks from Precambrian to Cretaceous in age. It is an arkosic conglomerate with rounded to sub-angular clasts of Precambrian quartz and lesser amounts of granitic, sedimentary and volcanic fragments ranging in size from pebbles to boulders more than 3 ft in diameter. The larger clasts lie in a matrix of ferruginous calcite-cemented, fine-grained quartz, feldspars and mica. The Telluride Conglomerate is exposed in red to grey cliffs below the Project’s facilities in the Sneffels Creek Valley. The unit pinches and swells and contains discontinuous lenses of sandstone and siltstone. The Telluride Conglomerate hosted significant base-metal replacement bodies in the nearby Idarado and Camp Bird mines where veins intersected lenses of porous and reactive host carbonate. Because of this, the Telluride Conglomerate is considered an economically important rock unit in the district. Further drilling will be required to test for potential economic viability in the area below the Revenue Vein mining area.

San Juan Formation

The San Juan Formation is the most extensively exposed rock unit in the vicinity of the Project. Within the mine workings it is exposed over more than 2,000 vertical feet from the 8th Level down to the lowermost -700 Level of the mine. It is the host for the majority of the mineralization.

The unit is grey to maroon and is made up of heterogeneous, intermediate composition volcanic fragments. Clasts range in composition from andesite to quartz latite and some clasts are porphyritic within a very fine-grained groundmass. Like many of the volcanic units in the western San Juan Mountains, it is composed of mud flows, pyroclastic breccias, and water-lain tuffs. The unit was likely deposited upon partially dissected flanks of active volcanoes (Lipman et al., 1973). Lipman et al. (1973) dated material from a flow breccia at 32.1 Ma.

Mapping in the district by Burbank and Luedke (1964, 1966) and Luedke and Burbank (1962) shows the unit to be 2,000 to 2,600 ft thick, similar to its thickness in the mine. Depending on the particular facies, the unit is fairly resistant and tends to form steep slopes and cliffs.

Picayune Formation

Near the mine, the Picayune Formation occurs as a 50 to 100 ft thick lava flow resting unconformably on the San Juan Formation. It is generally a dark amygdaloidal porphyritic andesite to rhyodacite with 2-to-3-millimeter (mm) gray to white subhedral oligoclase laths. Burbank and Luedke (1966) interpret the unit to be the lowermost member of the Silverton Volcanic Group, but Lipman et al. (1973) interpret the unit to be a “down faulted vent-facies accumulation forming the cores of early central volcanoes that were the source of the mudflow breccias in the San Juan Formation”. However, Coxe (1985) disputes that interpretation noting that near the Project the Picayune Formation occurs as a relatively thin and continuous flow overlying more than 2,000 ft of San Juan tuff and deems it to be geologically improbable as an adequate source unit. Coxe (1985) also notes that the unit is altered and most of the original dark minerals are no longer identifiable and exist as some mix of chlorite, quartz and iron-titanium oxides.

Eureka Tuff

The Eureka Tuff is a medium to dark colored rhyodacitic to quartz latitic welded ash flow tuff with abundant lithic fragments derived from similar composition lava (Burbank and Luedke, 1966). In the Project area the unit is discontinuous, lying unconformably on the irregular surface of the Picayune Formation, which had been thinned by erosion. Where present, the Eureka Formation can be up to 200 ft thick.

Lipman et al (1973) reinterpreted the unit as part of the Sapinero Mesa Tuff. However, since the Eureka tuff occurs nearly 1,000 ft stratigraphically below the Sapinero Mesa Tuff in the Revenue Mine area, Coxe (1985) is of the opinion that the Eureka Tuff represents more locally derived material from one of the earlier intermediate composition eruptions from the nearby San Juan caldera and is not part of the Sapinero Mesa Tuff.

Burns Formation

The Burns Formation (a 0 to 230 ft-thick discontinuous unit) is best developed as an intra-caldera volcanic unit with complex facies that include lava flows, mud flows, breccias and tuffs. The unit is thought to have been deposited from several local sources in a topographically complex environment. The eruptive facies of the unit in particular extend beyond the rim of the Silverton Caldera and at least

as far north as the Camp Bird Mine. The Burns Formation crops out in the area but is interpreted to pinch out short of where it would be expected to intersect the Project workings.

Gilpin Peak Tuff

The Gilpin Peak Tuff represents a collection of separate units, and these are the highest units exposed in the Project area. The Gilpin Peak Tuff consists of several mapped units with four of these units outcropping in the high peaks near the Project. The base of the Gilpin Peak group (considered the lowermost group) occurs at about 12,400 ft elevation and all of the remaining units occur above this topographic level (Coxe, 1985).

Dikes

Regionally, dikes are abundant and crosscut all of the volcanic units. The dikes range in thickness from 2 to 20 ft, are mostly northwest trending and typically dip at 65° or steeper. These dikes vary from dense aphanitic to porphyritic andesites containing up to 20% phenocrysts (Coxe, 1985). Burbank (1941) notes that “some veins that follow dike walls are mineralized for horizontal stretches of 25,000 ft or more, though not retaining commercial grade throughout.”

Northwest trending andesite dikes are common within the Project area. The Virginius Vein lies within or along the contact of an andesite dike (Virginius dike). For most of its mined extent to date, the dike occurs as the host rock, and other times as the hanging or footwall contact (Figure 7-3), to the vein. SRK considers the location of the dike to be important in defining the geological setting within the Virginius system. This is important due to the relatively thin nature of the vein itself to assist in guiding exploration both during the current and future phases of exploration. This dike likely plays some role in the mineralizing process, even if only to mark a structurally weak pathway for later solutions to follow.

The Virginius dike is an aphanitic to slightly porphyritic andesite that averages about 8 ft in thickness. It is easily recognized because it forms a blocky pattern along the mine’s ribs where it is exposed (Coxe, 1985). The dike’s aphanitic groundmass is chloritized with some small (0.2 mm) plagioclase microlites. Coxe (1985) says that up to 10% of the rock consists of 1 to 2 mm andesine feldspar phenocrysts but otherwise hydrothermal alteration has destroyed the primary mineralogy.

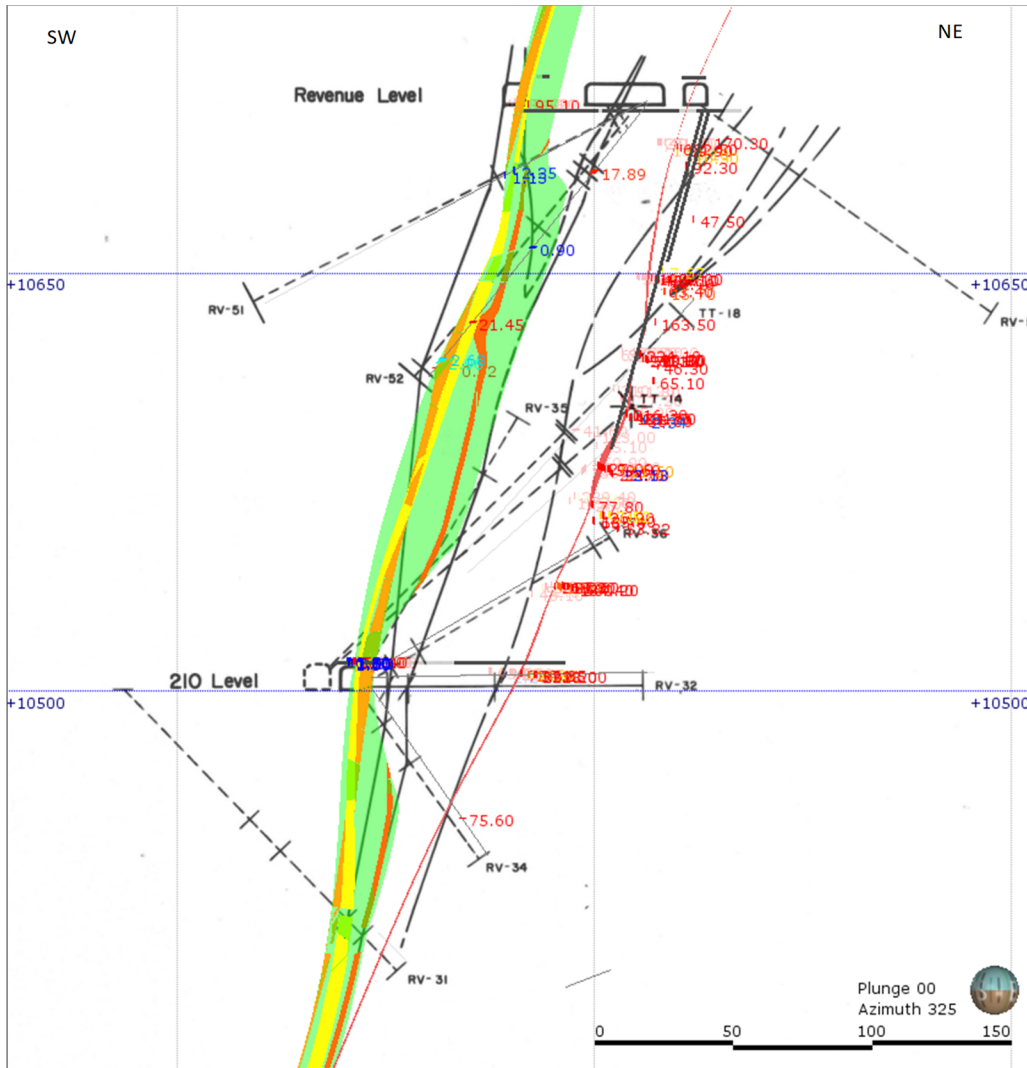

Source: SRK - geological revision, 2017

Figure 7-3: Example of the Role of Dikes in the Geological Model, Completed During Initial Geological Review by SRK During 2015 (Section viewing NW)

Structure

Pre-Tertiary structural events are evident in the deeply eroded Uncompahgre Gorge south of Ouray. Precambrian through Cretaceous rocks are exposed and display several episodes of intense deformation. Overlying these rocks are moderately folded and faulted Paleozoic to Mesozoic units. During the Laramide orogeny this package of rocks was domed, and earlier faulting was reactivated. A later period of movement along these faults can be seen where they offset the overlying San Juan Formation. This is likely the earliest structural event that may be directly relevant to the structural and mineralization history of the Revenue Mine area (Luedke and Burbank, 1962; Burbank and Luedke, 1964).

Virtually all of the structural developments relevant to mineralization are related to the several major caldera events in the region, particularly the Silverton, San Juan and Uncompahgre Calderas that are to the east of the Project and to the caldera-concurrent emplacement of the Stony Mountain Stock.

These calderas cover an area approximately 15 mi x 30 mi in extent (Figure 7-4) and include four nested calderas within a larger collapse feature. The initial doming and subsequent collapse of these calderas formed a very complex pattern of concentric and radial fractures that control most of the veins and dikes in the region, and although somewhat obscured by deposition and erosion, still are recognizable in the topography today. The Stony Mountain Stock, which lies some five to six miles northwest of the rim of the Silverton Caldera, seems to be structurally connected to the Silverton Caldera by a very prominent fault-vein-dike swarm called the Sneffels Axis. Near the caldera rim the concentric and radial faults seem to have been developing at the same time as they truncate and/or offset each other.

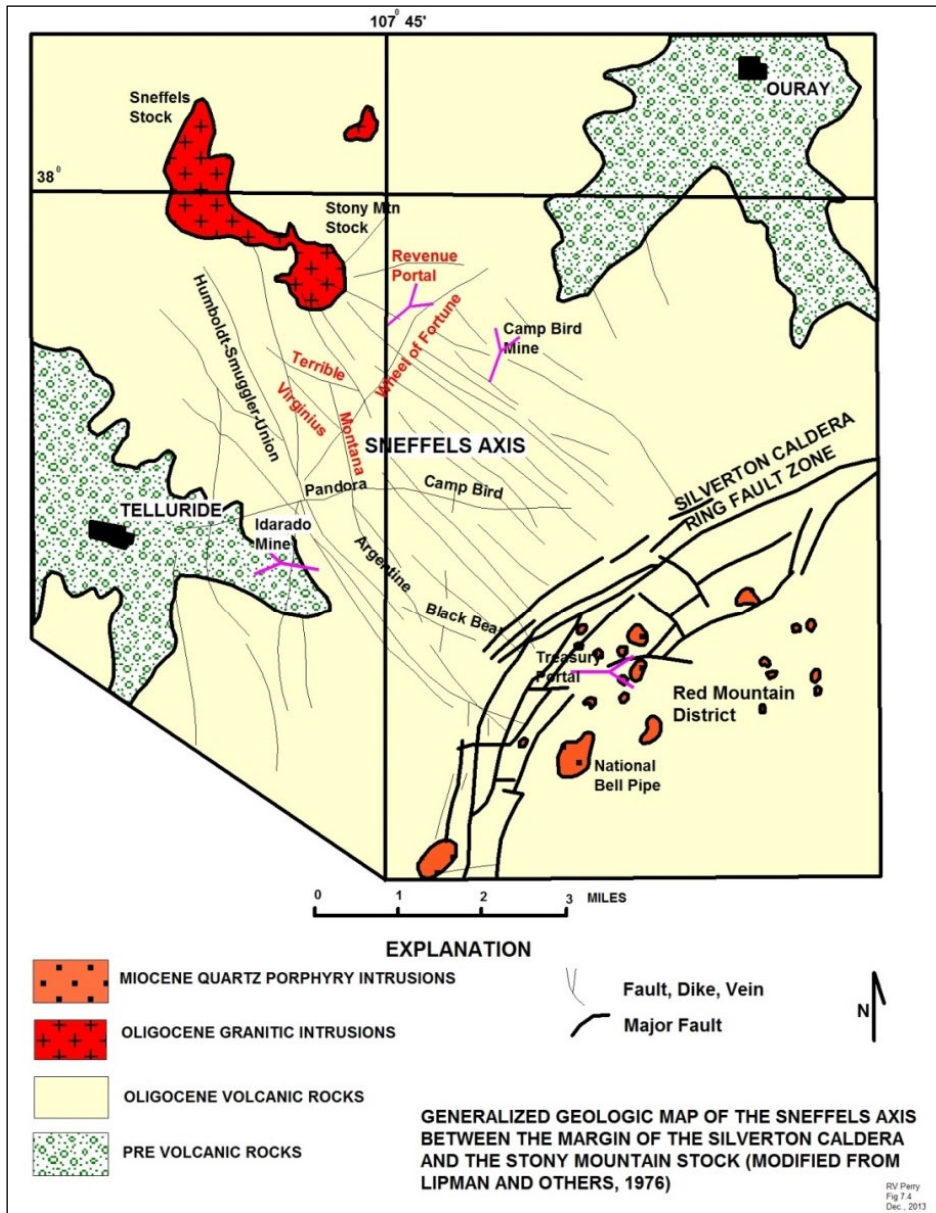

Source: Modified from Lipman et al, 1976

Figure 7-4: Important Structural Features and Principal Veins in the Project Area

According to Burbank (1941), dikes fill many of the radial structures near the Stony Mountain Stock, but further to the southeast along the Sneffels Axis, the proportion of dike-filled structures significantly decreases. The central portion of the Sneffels Axis reaches roughly six mi in width. Across the axis, the structures change from southwest dipping on the southwest side to steeply northeast dipping on the northeast side. Burbank (1941) cites this as evidence that these normal faults formed largely in response to a down, rather than up, warping of the crust along the axis. Total vertical sagging across the axis is estimated to be 200 to 500 ft and Burbank (1941) states that the axis developed late, at least post Picayune Formation deposition, since the thickness of the Picayune Formation stays constant across the axis rather than thickening due to ponding in the middle if it had been deposited into an existing depression. The Virginius, Yellow Rose and Terrible Veins are all part of the Sneffels Axis group of structures and are situated in the central portion of the axis.

Alteration

Much of the volcanic pile throughout the western San Juan Mountains was subjected to mild to strong propylitic alteration resulting in pervasive chlorite and calcite alteration with more intensely altered areas also displaying epidote and pyrite. Coxe (1985) states that the type of wall rock along the Virginius Vein determined the nature of the alteration.

The Virginius andesite dike displays only minor alteration consisting of chlorite or calcite replacement of the mafic minerals and plagioclase. The adjacent San Juan Formation shows stronger propylitic alteration. Microscopically, the primary minerals have been replaced with sericite, chlorite, hematite and other oxides. Higher in the section the Gilpin Peak ash flow layers display similar alteration to the San Juan Formation (Coxe, 1985).

Mineralizing fluids further altered the rocks adjacent to the veins but typically over shorter distances of about 2 ft in the San Juan Formation and 7 ft in the overlying Gilpin Peak units (Coxe, 1985). Coxe (1985) observed that more distal, vein-related alteration was dominated by chlorite while sericite was dominant nearer the vein and tends to impart a bleached look to the rocks. Concentrations of pyrite, siderite and quartz increase to within 2 to 9 inches of the vein where Coxe (1985) states that quartz and sericite replace all of the siderite and calcite. Although there are mineralogical changes in the altered zone adjacent to the veins, primary breccia textures almost completely survive the alteration process (Coxe, 1985).

7.4 Significant Mineralized Zones

Mineralization in the District is found primarily in sub-vertical fissure veins and is classified as a telescoped epithermal quartz vein type deposit. The veins are characterized by somewhat constrained vertical extents (generally less than 1,000 ft) and a vertical zoning that favors precious metals in the upper levels grading into more base-metal rich mineralization with depth.

The mineralogy found at the Project is consistent with this type of mineralization and includes galena, sphalerite, tetrahedrite, polybasite, chalcopyrite, pyrite, arsenopyrite, marcasite as well as ferroan rhodonite, calcian-ferroan rhodochrosite, quartz and chlorite.

There is also potential, based on production from the Campbird and Idarado Mines which are contiguous with the OSMI property, for replacement mineralization within the calcareous Telluride Conglomerate with up to 80% massive sulfide. Replacement mineralization has not been fully identified in the Project to date, but three drill holes were drilled into the Telluride Conglomerate during exploration by Ranchers and one intersection pierced the vein inside the Telluride Conglomerate with

high-grade mineralization reported. Further exploration will be required to determine the potential, and there is no guarantee that future exploration will yield positive results. The Telluride Conglomerate remains a significant exploration target once suitable drilling locations from lower levels of the mine can be achieved.

Lipman et al. (1976) made a comprehensive effort to age date material from numerous mines in the western San Juan Mountains. They identified mineralization dating from as early as 29.6 Ma southeast of the Uncompahgre Caldera to as young as 10.2 Ma for mineralization at Camp Bird Mine in the District. The more significant deposits tend to date in a narrower range of 22.5 to 16 Ma. Table 7-2 summarizes some of the important dates in the district.

Table 7-2: Age Dates of Mineralization from the Northwestern San Juan Mountains

Area or Deposit	Age Date	Comment
SE of Uncompahgre Caldera	29.6 Ma	Disseminated mineralization in the core of a strato-volcano
Capitol City District Veins, 9 miles west of Lake City	Around 26.7 Ma	Likely coeval with development of Silverton/Uncompahgre Calderas
Chimney type deposits in the Red Mountain District	22.5 Ma	Contemporaneous with Lake City Caldera
Replacement mineralization in the Argentine Vein	*17.0 Ma and 13.1 Ma	*This is the more reliable of the two dates and is derived from K-feldspar
Shenandoah-Dives Vein from southeast of Silverton	16 to 17 Ma	Roughly equivalent to age of veins northwest of the Silverton caldera
Sunnyside Vein north of Silverton in the Eureka Graben	Between 13.0 and 16.6 Ma	Age date from Casadevall and Ohmoto, 1977
Camp Bird Vein	10.5 Ma and 10.2 Ma	The young age is just one of several ways this vein is distinct from most in the area

Source: Lipman et al. (1976); Casadevall and Ohmoto (1977)

The following discussion of the important veins within the Project area is taken in part from a Star Mines' internal report written by Stephen Zahony (Zahony, 2013B). Figure 7-5 shows the relation between the Yellow Rose, Virginus and Terrible Veins as well as additional veins that are exploration targets for OSMI along the trace of the Revenue Tunnel.

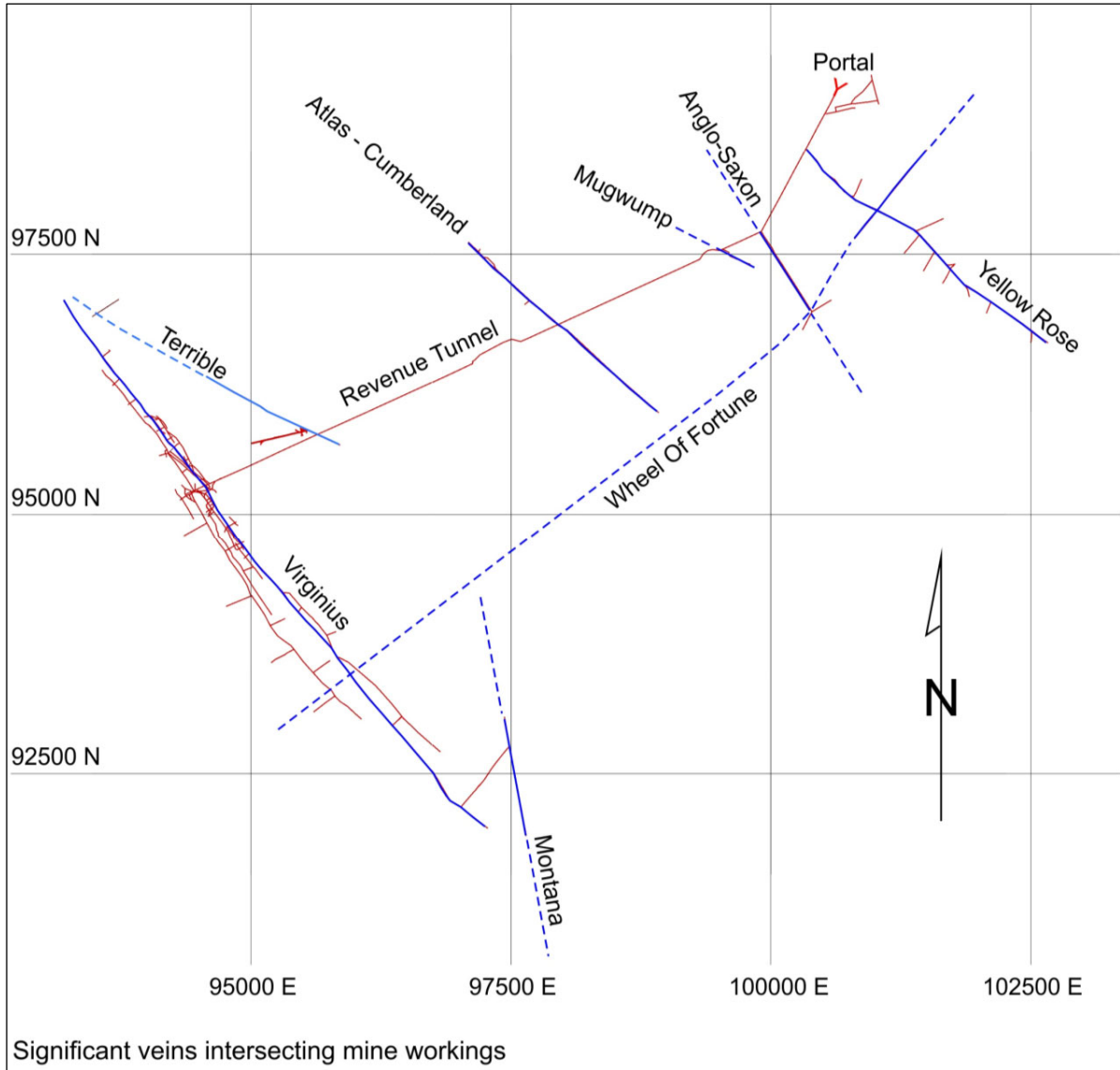

Source: OSMI, 2017

Figure 7-5: Revenue Tunnel and the Yellow Rose, Terrible and Virginius Veins

Virginius Vein System

The most historically productive vein system at the Project is the Virginius and its northern extension, which is sometimes referred to as the Monongahela Vein. Reference to the Virginius Vein in this report will include the Monongahela. Between 1875 and 1906, this vein system is estimated to have produced over 15 Moz of silver with “significant lead and gold credits”.

Rather than being a single continuous vein, the vein occurs as an intermittently stacked/anastomosing system of one to three sub parallel veins separated by up to 100 ft. Frequent reference is made to the “hangingwall”, “footwall” and “main” vein and all have been productive in different parts of the mine. Sunshine subdivided the Virginius into six sub-veins as listed below:

- FW for the footwall vein
- HW for the hanging wall vein
- V1 for the vein within the Virginius dike
- V2 for the vein on the footwall of the Virginius dike
- V3 for the vein on the hanging wall of the Virginius dike
- UK and QM for two minor veins between the footwall vein and the dike

Given these several parallel vein strands, questions remain if in all cases where stoping has followed the main vein or one of the several splits during mining.

The Virginius Vein in the north-northwest heading from the Revenue Tunnel is continuous over long strike (11,700 ft based on mapping) and dip distances and historic stoping occurs extensively within a zone 3,600 ft along strike and 2,500 vertical ft. The vein is typically averages about 1.5 ft or less in width although it can be as thick as 3 ft. The largest intercept on the vein recorded in the database was approximately 7 ft. It is reported to be a galena bearing vein, with perhaps 2 ft of altered and weakly mineralized rock on either side. Wallrock beyond that total width is weakly altered to unaltered and makes for relatively stable walls for mining purposes. More recent exposure by OSMI shows the vein widths can be more variable and reach widths of over 2 ft to 3 ft on a local scale in exposures during test stopes mined in 2016. The average width of the vein within the current Mineral Resources is estimated at approximately 1.3 ft.

The vein strikes from N45°W (near the 3rd Level portal) to N25°W in the northwest part of the mine (Coxe, 1985). In the upper workings, the vein is nearly vertical or even steeply northeast dipping in places. The vein is reported to outcrop at surface but is difficult to trace with confidence due to the rugged nature of the topography, snow cover and talus. An interpreted trace of the vein at surface has been used by SRK during the geological modelling stage. An inflection occurs at approximately the 6th level where the vein establishes a southwest dip that persists to the lowest workings, varying from 45° to 75° but typically dipping 65° to 75° southwest.

In the mine, the vein tends to follow the Virginius andesite dike and can occur as the hanging wall, footwall or interior to the dike although close proximity is almost always the case. The dike is strongly altered with much of the original mineralogy and texture destroyed or replaced. It does not appear that the vein is genetically related to the dike but may rather simply follow the same zone of weakness that the dike exploited.

The vein tends to be narrow but continuous and typically consists of quartz with variable amounts of galena, tetrahedrite, polybasite, sphalerite, chalcopyrite and pyrite. The mineralogy of the vein is remarkably constant over the very large vertical and horizontal span, although the silver grade is variable (Benham, 1980). Tetrahedrite and polybasite are the principal silver minerals in the mine and can reach concentrations of 15% silver by weight.

Yellow Rose Vein

Development of the Revenue Tunnel provided deep access to several veins in the District including the Yellow Rose Vein. The Yellow Rose is a northwest trending vein sub-parallel to the Virginius located more than 5,000 ft to the northeast. The Yellow Rose was mined to a minor extent in the early years following development of the Revenue Tunnel and was explored by Ranchers, Sunshine and Star Mines over a length of approximately 3,800 ft and a down dip extension of approximately 550 ft. The vein zone has been mapped over 16,000 ft at surface. Like the Virginius, the Yellow Rose Vein

dips steeply to the southwest and consists of several anastomosing veins within a broader structural zone. The mineralogy of the Yellow Rose is similar to the Virginus, but in general it is a wider vein averaging approximately 3 ft. The widest vein intercept sampled is approximately 10 ft with the smallest intercept at 0.1 ft. The Yellow Rose is considered to be a lower grade target than Virginus. Unlike the Virginus, the Yellow Rose does not follow a dike, which may result in more difficult mining conditions due to hangingwall and footwall conditions.

Terrible Vein System

The Terrible Vein has an overall N60°W strike with a steep southwesterly dip. Historical production came from workings with portals on three levels spaced at about 100 vertical feet with adits along the south slopes of Governor Basin ranging in elevation from 12,050 to 12,270 ft. A 4th and 5th Level were reached by means of internal shafts but stoping only occurred above the 4th Level or above 11,950 ft elevation. The Terrible Vein system is intersected by the Revenue Tunnel and followed by a drift to the northwest of the tunnel for 1,202 ft and to the southeast for 850 ft. The vein tends to be narrow but continuous and typically consists of quartz with variable amounts of galena, tetrahedrite, polybasite, sphalerite, chalcopyrite and pyrite, similarly to the Virginus Vein and other veins in the vicinity.

The intersection of the Terrible Vein with the Virginus Vein system was identified as an exploration target by Ranchers who drilled one core hole from the surface. Sunshine drilled two holes in this region in 1995, and Star Mines drilled an additional 30 surface core holes into this target. Due to the extreme topography, some of the drilling is highly oblique to the vein orientation and in some cases, did not intersect the vein. The results from this drilling where the vein has been intersected show a sufficient degree of continuity at the northern end, contributing to the current Mineral Resource estimate.

The lower levels of the vein have been intersected from a raise at the northern end of the Terrible drift, located on the Revenue tunnel level. All material within the region of the Terrible drift is considered to be below the economic cut-off based on the current sampling. These samples are in general low-grade but have been used to confirm the orientation of the vein in the current model.

8 Deposit Type

8.1 Mineral Deposit

The Project's vein deposits and the several associated veins within the mine are classified as volcanic-hosted epithermal base and precious metal vein type deposits. These deposits are sometimes referred to as intermediate sulfidation epithermal deposits typically characterized as high in silver and gold with or without base metals, associated with andesite volcanism and structurally controlled.

At Virginius, chalcedonic quartz and cockscomb textures have been observed and late euhedral calcite is found in places. Fluid inclusion studies suggest that boiling did not occur in the system. However, the presence of breccia in places indicates that at least some boiling occurred (Sunshine, 2001; Coxe, 1985).

SRK is of the opinion that the Company is applying an appropriate deposit model to the Project for use in exploration.

9 Exploration

9.1 Relevant Exploration Work

The majority of exploration and underground sampling on the Project (namely on the Virginius, Terrible, and Yellow Rose Veins), were completed by previous operators. Limited documented information is available on the exploration methods and techniques used prior to the Star Mines exploration programs, which were documented in previous technical reports. SRK reviewed the information as part of previous commissions and the following provides a brief summary of the work.

9.2 Sampling Methods and Sample Quality

Prior to Star Mines, the available exploration records started with Camp Bird's in 1966 and continued with Ranchers and then Sunshine's work on the Project.

Table 9-1 shows exploration work completed during the period of 1966 to 2001 in the Project area. The number of drillholes reflects all drillholes drilled at the Project and includes targets outside the Yellow Rose, Virginius and Terrible Veins (Figure 9-1).

Table 9-1: Exploration Work Completed Between 1966 and 2001

Historical Sampling 1966 to 2001	# of Completed Work
Surface Exploration Rockchip Samples	9
Surface Samples of Dumps and Tailings	0
Underground Channel Samples	1,286
Surface Core Holes	161
Underground Core Holes	309

Source: Star Mines, 2013

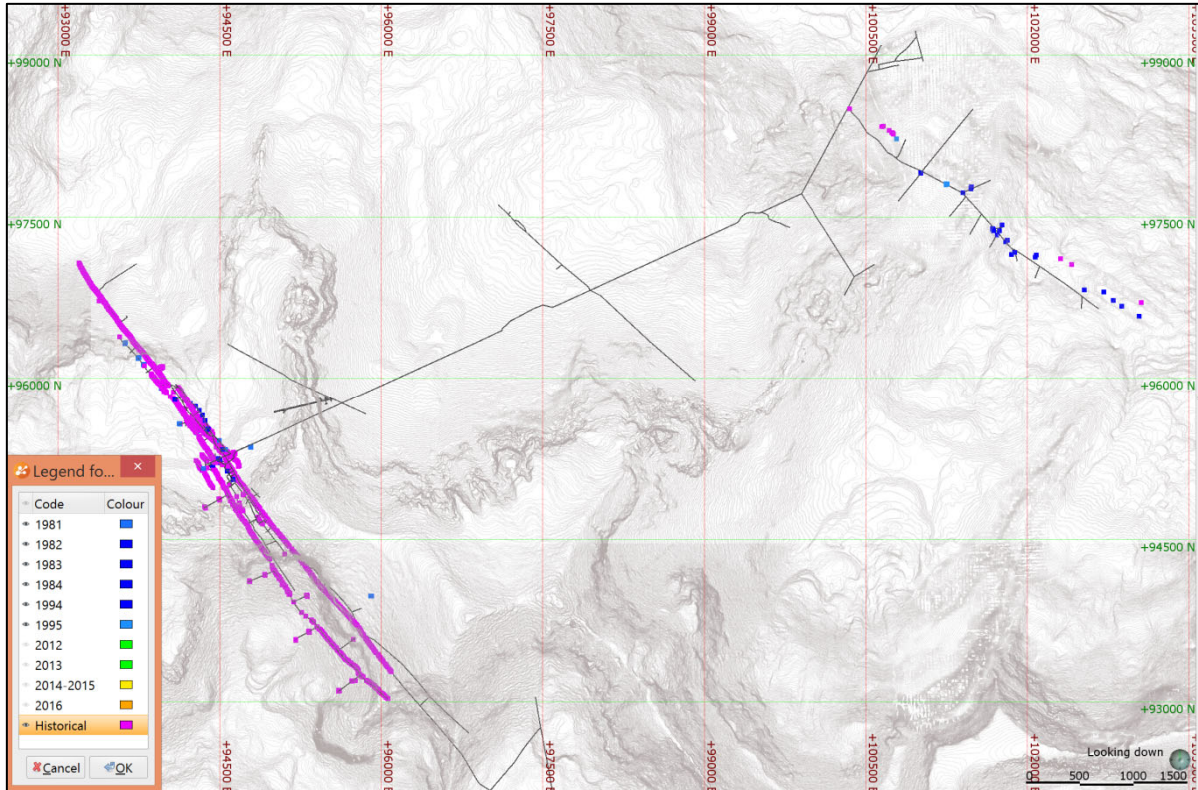

Source: SRK: 2016

Figure 9-1: Historical Underground Samples

The channel sampling programs typically focused on particular sections of various veins. Samples were collected on 6 to 10 ft centers along the vein with samples taken across the vein width and typically in the range of 0.5 to 2 ft. Samples were collected using a hammer and chisel and were a continuous, chip channel sample. The samples were reported to be collected to be as continuous as possible using the available equipment (Figure 9-2).

Camp Bird, Ranchers and Sunshine were successful underground mining companies and the work completed by these companies was considered industry standard for the period when the work was completed.

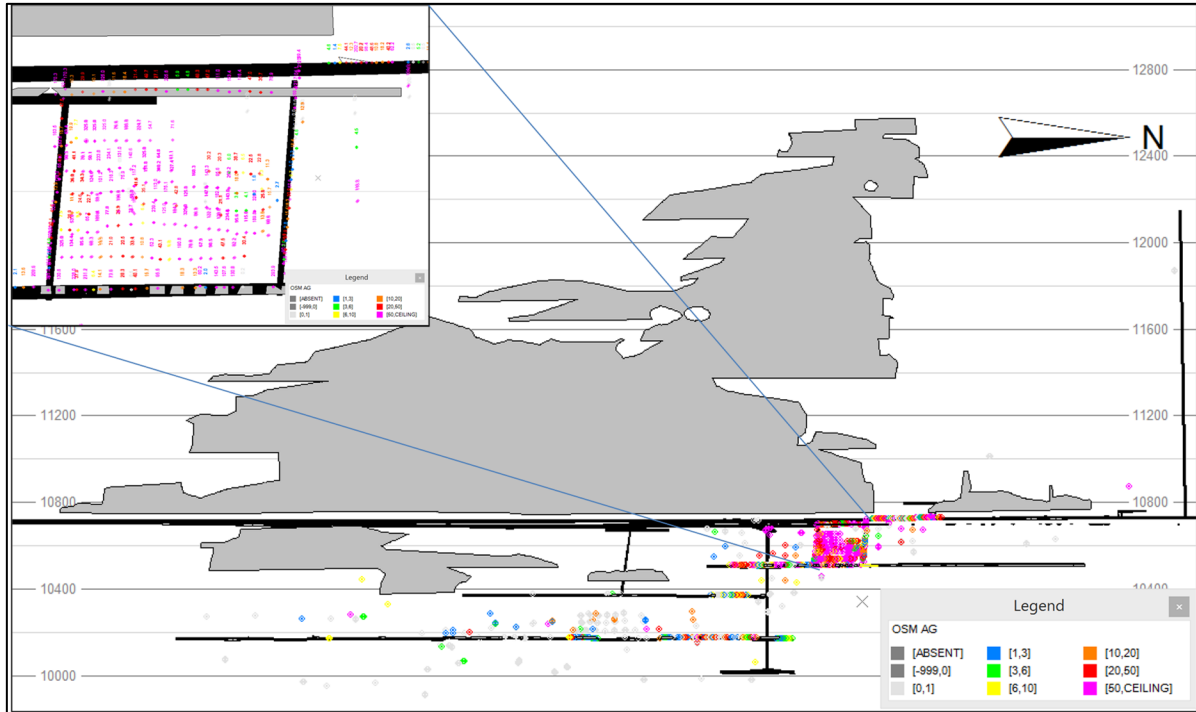

Source: SRK, 2016

Figure 9-2: Historical Sampling within F9 Stope

9.2.1 2011 - 2013 Star Mines

During this period, the mine was under ownership of Star Mines. Star Mine’s exploration efforts began in 2012, continued through 2013 and included surface and underground sampling as well as surface and underground drilling. Principal exploration effort has been a combination of surface and underground core drilling in the Virginius, Terrible, Wheel of Fortune and Yellow Rose Veins and exploration and development drifting in the Yellow Rose Vein. Star Mines also collected exploration samples from outcropping veins, systematically sampled mine dumps and collected channel samples in the Yellow Rose Vein from underground. A summary of the completed exploration work by Star Mines is shown in Table 9-2.

Table 9-2: Exploration Work Completed between 2012 and 2013

Star Mines Sampling 2012 to 2013	Star Mines 2012	Star Mines 2013
Chip Samples of Outcrops	0	818
Underground Channel Samples	0	201
Surface Core Holes	39	33
Underground Core Holes	33	0

Source: Star Mines, 2013

Star Mines used the same channel sampling techniques as Ranchers. The channel sampling programs were completed on 6 to 10 ft centers along the vein with samples taken across the vein width. Samples were collected using a hammer and chisel and were a continuous, chip channel sample. The samples were collected to be as continuous as possible using the available equipment.

Star Mines investigated the possibility of processing material from the Atlas Tailings and Virginius mine dump. As part of this, Star Mines sampled the Atlas historic tailings, which are located northwest of the Revenue Portal. Star Mines collected 269 samples on a nominal grid of 35 ft x 35 ft. The Virginius mine dump located at the 3-Level in Governor Basin was sampled on a 5 ft x 25 ft grid by digging 1 ft deep pits. There were 542 samples collected from this site. Preliminary results indicated that there is the possibility of processing the Atlas tails and Virginius dump material, but additional evaluation is required for both targets, which has not been completed at this time (Figure 9-3).

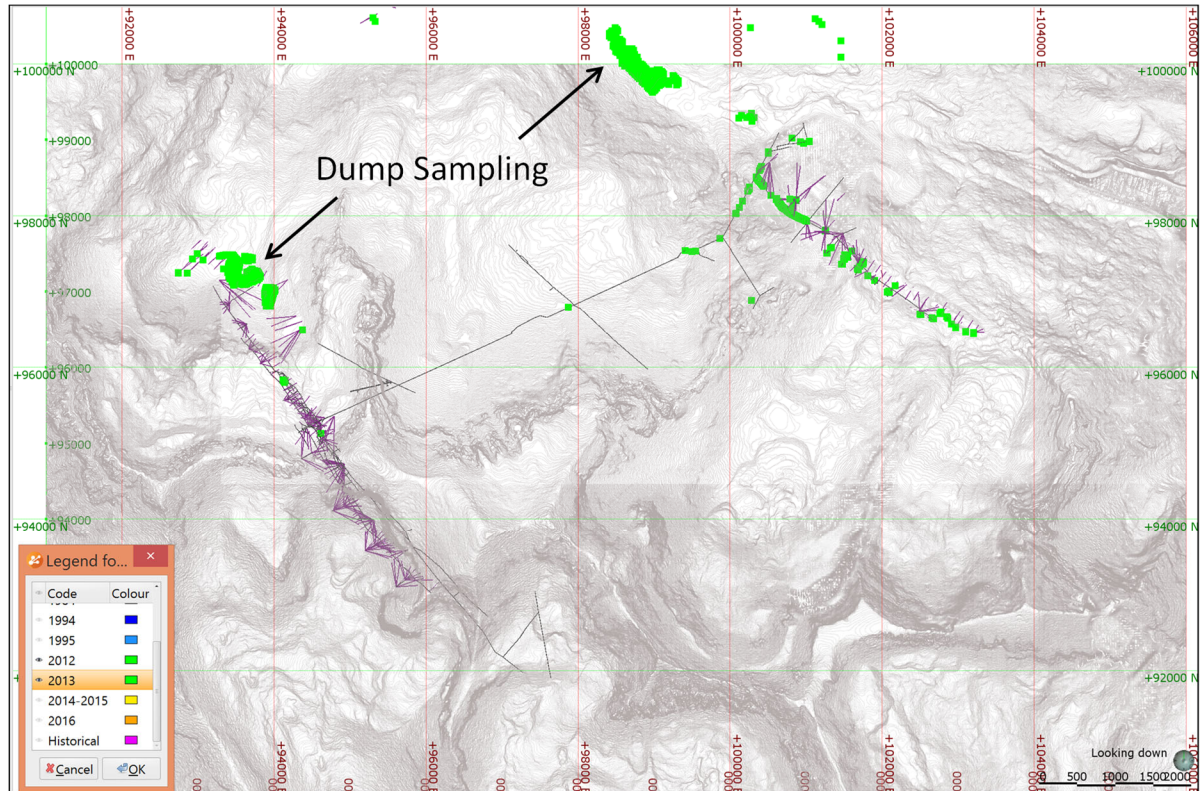

Source: SRK, 2016

Figure 9-3: Collar Plot Showing Sampling and Drilling Collar Locations - 2012 to 2013

9.2.2 FRSM and OSMI Exploration

Between 2014 and 2015, the mine remained in operation during this period, routine mine sampling was completed using the same continuous chip sampling procedure. A total of 608 channel samples were taken between 2014 and 2015 from with the Yellow Rose Vein, and the Monongahela and Virginius Veins (Figure 9-4).

OSMI has completed an initial phase of underground drilling and limited channel sampling on the Virginius Vein; no additional work has been completed on the Yellow Rose Vein.

The focus of OSMI’s 2016 exploration program was to complete a series of underground drillholes along Virginius Vein at the northern end of the Revenue level of the mine, which is discussed in more detail in Section 10 of this report.

In addition to the underground drilling programs, OSMI has conducted a series of channel sampling from relevant vein exposures, where access remains available, for example, within a test resue stope in this same area and more recently within the scam drive below an area of the mine known as the Federal stope.

In 2016 OSMI used the same channel sampling techniques as the previous explorers. The channel sampling programs were completed on 6 to 10 ft centers along the vein with samples taken across the vein width. Samples were collected using a hammer and chisel and were a continuous, chip channel sample. The samples were collected to be as continuous as possible using the available equipment.

A total of 23 samples were taken in 2016 as part of the resue stoping test. Further sampling of the resue test stope occurred earlier in 2017, which returned grades ranging from 0.8 to 30.0 oz/t Ag, with an average grade of 5.0 oz/t Ag. The initial five samples out of 23 averaged 10.0 oz/t Ag within the stope. Note that the location selected for the test stope was in an easily accessible lower grade area.

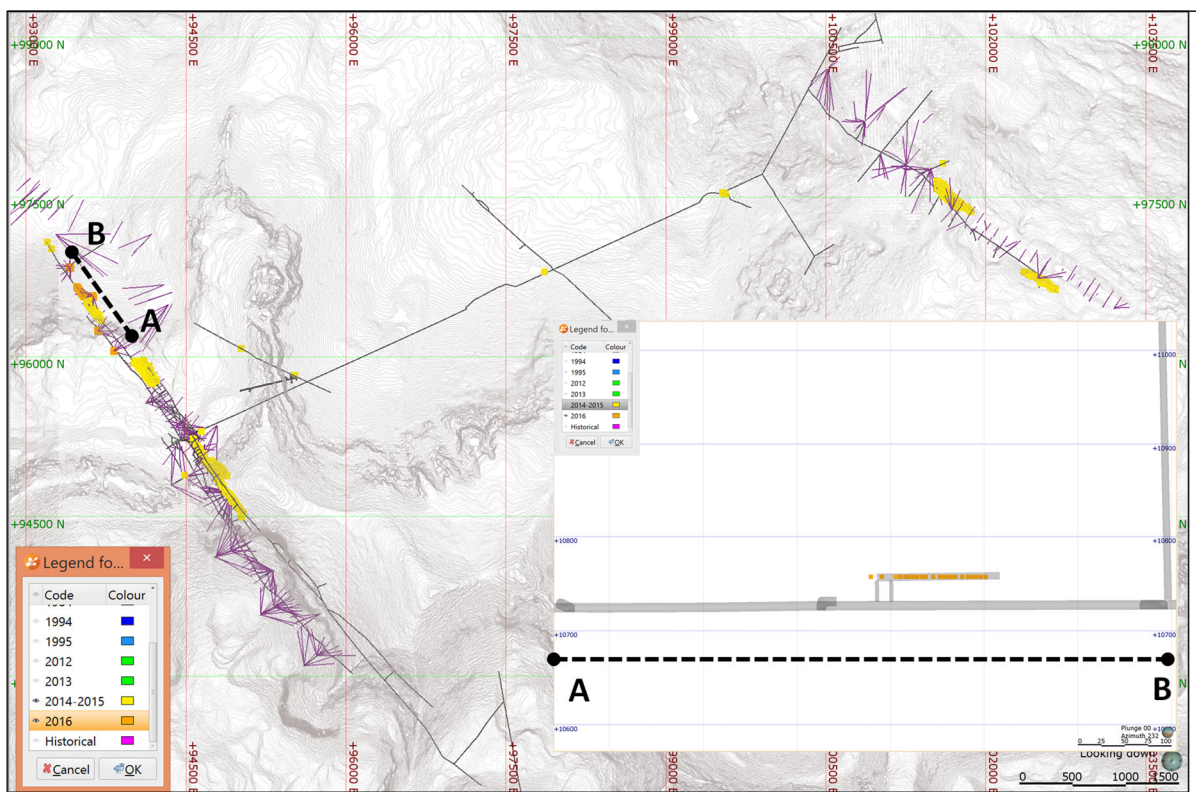

Source: SRK, 2017

Figure 9-4: OSMI Sampling Locations

9.2.3 Production Sampling

Between 2020 and In 2021 OSMI took a total of 407 samples which are described as production samples taken as part of the routine mining advance. These samples were taken from the advance face of the exposed vein, with the contacts marked up and chip samples taken in a predefined pattern within the vein. Face samples of entire vertical face were taken on 6'-12' linear intervals from hanging wall to foot wall contacts. Samples were taken from both development advance faces and stope backs. SRK has been provided with the underground procedures which have been reviewed. In

summary the processes are similar but differ related to the added safety risks of sampling overhead. In both cases mapping was completed prior to sampling. In the face the exposed vein was split into four channels, with the vein width recorded. Sampling was completed using a continuous chipping method from left to right (hangingwall to footwall) and were taken perpendicularly across the width of the vein. Samples were initially caught on a tarp, and then transferred to a sample bag until a minimum weight was achieved. Each sample bag was labelled with the advance shot number for future reference.

The database provided includes details on the geological coding, vein width and assays for Au, Ag, Pb, Zn and Cu. No QA/QC samples were included in the submission of the production samples, which were submitted to Hazen laboratory in Colorado for analysis. Hazen holds analytical certifications from state regulatory agencies and from the US Environmental Protection Agency (EPA). Hazen maintains a large stock of standard reference materials from the National Institute of Standards and Technology (NIST), the Canada Centre for Mineral and Energy Technology (CANMET), the EPA, and other sources.

SRK notes the underground production samples have been stored in the database as linear samples along the strike of the vein to represent each advance. OSMI currently is using underground mapping on a round by round basis to define the contact points for local assessment, which are reconciled to underground survey points. Until additional QA/QC steps are taken, this limits the use of the production samples for estimation purposes

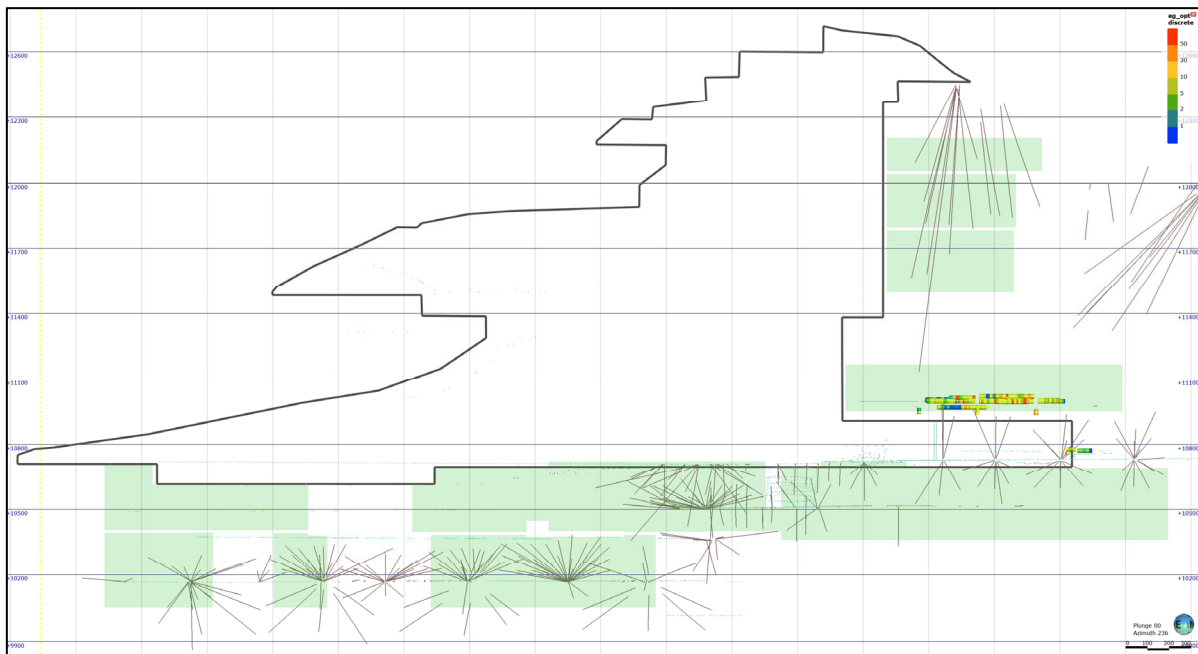

Source: SRK, 2022

Figure 9-5: Location of OSMI Production Sampling

9.3 Significant Results and Interpretation

A total of 2,331 underground channel samples and 811 waste dump samples have been collected to date and incorporated into the current model update. The focus of the most recent sampling has been

within the northwest of the Virginius Vein (Monongahela) and south of the Revenue Tunnel where the vein has been accessed via a hangingwall ramp.

Figure 9-6 shows the locations of the channel sampling relative to the underground development. To date, the work has focused on the two main veins, and some historical sampling information exists for additional veins, which if captured, may aid in assessing the potential for these structures.

The production sampling is considered a continuous chip sample and is consistent with procedures used within the USA. To increase the confidence in the sampling process SRK recommends that OSMI consider using diamond saws to cut representative channels across the full width of the vein prior to sampling campaigns, to ensure more consistent sample volumes are achieved. Sampling has been completed across the width of the vein within the face during advance and is therefore assumed to be representative.

SRK accepted the underground sampling within the current estimates but has not used surface sampling during the geological modelling or estimation process.

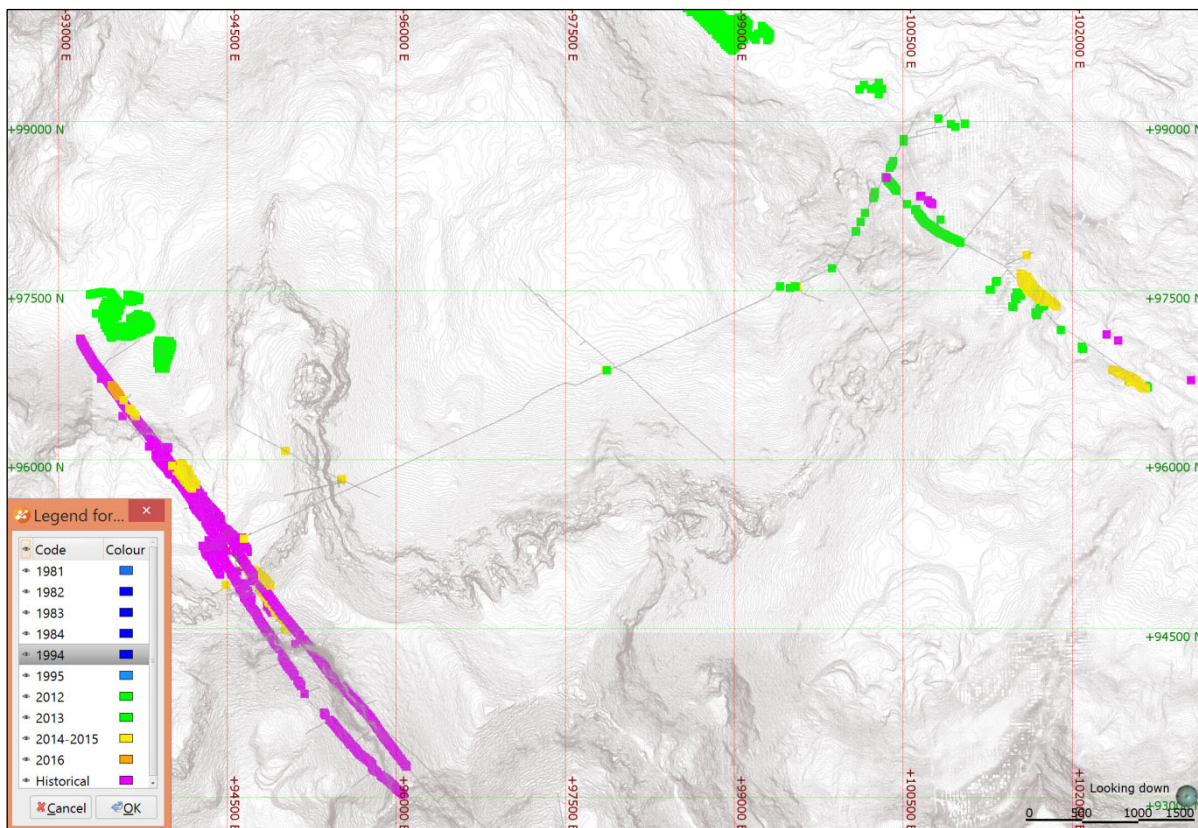

Source: SRK, 2017

Figure 9-6: Summary of Exploration Sampling by Year

10 Drilling

10.1 Type and Extent

Prior to 1966, the Project was explored and developed by conventional underground drifting and shaft sinking. Given the continuity along strike and dip of the mineralization, this technique was cost effective for the earlier operators. There are no records of these early operators having completed any drilling on the Project.

The first modern exploration and development drilling occurred in 1966 when Federal Resources, explored the Project as a way to expand operations at the Camp Bird Mine. The Camp Bird Mine is a gold mine while the Project is a past silver producer.

- Camp Bird reopened some of the workings on the Virginius Vein below the Revenue Tunnel level and drilled seven core holes from the 350 Level totaling 1,140 ft of AQ (1.062 inches diameter)
- In 1968, Federal Resources expanded their efforts to include surface exploration and drilled six NX (2.155 inches diameter) sized core holes on the Monongahela claim to explore the northern extension of the Virginius Vein. This surface drilling totaled 5,255 ft
- In 1980, Ranchers acquired control of the property. Ranchers drilled a total of 84,729 ft of core including 12,967 ft from the surface and 71,762 ft from underground. Ranchers' work included both surface and underground drilling, targeting the Virginius, Terrible and Yellow Rose Veins and other veins in the claim block, including the Banner-Governor and Highland Chief
- In 1994, Sunshine took control of the Project and mapped most of the accessible workings off the Revenue Level. Sunshine drilled 6,567 ft of NX core to explore several surface targets including the Yellow Rose, Wheel of Fortune, Mikado, Silver Queen and Terrible Veins
- Star Mines purchased the Project in 2011 and initiated a drilling program in 2012. Star Mine's target in 2012 was the Yellow Rose Vein. The Company drilled NQ core (1.875 inches diameter) completing 9,681 ft of drilling underground and 9,456 ft of drilling at the surface. Star Mines also drilled 8,540 ft of NQ core from surface on the Monongahela claim to explore the northern extension of the Virginius Vein. Additionally, Star Mines completed 2,516 ft of underground core drilling to explore the Wheel of Fortune Vein at the end of 2012
- In 2013, Star Mines drilled 20 NQ core holes from the surface in Governor Basin to explore the Terrible and Virginius Veins completing 11,868 ft
- In 2016, OSMI drilled 42 NQ core holes from underground in the northern portion of the Virginius Vein using an underground drilling rig with access from four crosscuts (two in the hangingwall and two in the footwall of the vein)

It is reported that the combined drilling on the Project since Federal Resources early efforts totals 147,481 ft of core including 92,829 ft from underground and 54,653 ft from the surface.

A portion of the historical core was retained in a warehouse on site at the Revenue Tunnel portal. This warehouse was broken into and vandalized under prior ownership sometime during 2001-2011. Pieces of core were stolen from core boxes and approximately 30% of the core was dumped. The core from drilling prior to Star Mine's ownership of the property that was not vandalized is stored in OSMI's core facility in Ouray, Colorado. All of the core from Star Mines' 2012 and 2013 drilling is also stored at this core facility. Core from the OSMI 2016 drilling program has been stored for short term near the Revenue Tunnel portal, for geological logging, with final storage at the Ouray warehouse.

Table 10-1 summarizes the drilling at the Project. Figure 10-1 and Figure 10-2 show the drillholes at the Yellow Rose, Virginus and Terrible, respectively. Most drilling has been completed from underground using fan drilling. In general, the angle of the vein to drilling is reasonable (Figure 10-3). In some cases, especially at lower levels of the mine, the angles are a little more oblique and may result in less ideal intersection angles. SRK recommends that the drilling intersection angles should be considered for any new drilling programs.

A small amount of drillholes (approximately 12) were not drilled into the current resource targets (Virginus, Terrible and Yellow Rose). The drill holes that are excluded were targeted on the Wheel of Fortune and Silver Queen Veins. However, the bulk of the drilling which included a total of 489 holes for 145,907 ft are currently in the database supplied to SRK.

Table 10-1: Total Core Drilling on the Project

Hole Nos.	Date	Company	Location	Core	Number of Surface Holes	Number of UG Holes	Surface (ft)	UG (ft)
DDH-1 to DDH-7	1966	Federal Resources	350 Level	AQ	7			1,140
DDH-M-1 to DH-M-6	1968	Federal Resources	Monongahela surface	NX		5	5,255	
Federal Resources				Total	7	5	5,255	1,140
BG-1 to BG-2	1981	Ranchers	Banner-Governor surface	NX	2		786	
M-1 to M-2	1981	Ranchers	Monongahela surface (Virginius Vein)	NX	2		1,690	
T-1	1981	Ranchers	Terrible Vein surface	NX	1		896	
HC-1	1981	Ranchers	Highland Chief surface	NX	1		405	
Y-1 to Y-24	1984	Ranchers	Yellow Rose Rev. L.	AQ & AW	24			7,557
YR-1 to YR-7	1981	Ranchers	Yellow Rose surface	NX	7		2,221	
YR-8 to YR-17	1982	Ranchers	Yellow Rose surface	NX	10		1,695	
YR-18 to YR-28	1983	Ranchers	Yellow Rose surface	NX	11		2,912	
YR-29 to YR 36	1984	Ranchers	Yellow Rose surface	NX	8		2,362	
RV-1 to RV-6	1981	Ranchers	Revenue Level	AX		6		2,953
RV-7 to RV-40	1981	Ranchers	Revenue Level	AQ		34		4,883
RV-50 to RV-53	1983	Ranchers	Revenue Level	AQ		4		553
RV-63 to RV-79	1983	Ranchers	Revenue Level	AQ		17		3,009
RV-80 to RV-85	1984	Ranchers	Revenue Level	AQ		6		1,246
TT-1 to TT-18	1983	Ranchers	210 Level	AQ		18		3,371
TT-19 to TT 43	1984	Ranchers	210 Level	AQ		25		5,655
TF-1 to TF-9	1982	Ranchers	350 level	AQ		9		1,927
FF-1 to FF-100	1983	Ranchers	550 Level	AQ		100		29,544
FF-101 to FF-152	1984	Ranchers	550 Level	AQ		52		11,065
Ranchers				Total	66	271	12,967	71,762
YR-37 to YR-43	1994	Sunshine	Yellow Rose surface	NX	7		2,820	
YR-44 to YR-46	1995	Sunshine	Yellow Rose surface	NX	3		1,177	
WF-2 to WF-3	1995	Sunshine	Wheel of Fortune surface	NX	2		455	
MK-1 to MK-2	1995	Sunshine	Mikado Vein surface	NX	2		660	
SQ-1 to SQ-2	1995	Sunshine	Silver Queen surface	NX	2		572	
T-2 to T-3	1995	Sunshine	Terrible Vein surface	NX	2		883	
Sunshine				Total	18		6,567	0
Y-25 to Y-50	2012	Star Mines	Yellow Rose	NQ		33		9,681
YR-47 to YR-66 (-75)	2012	Star Mines	Yellow Rose surface	NQ	31		9,456	
WOF-1 to WOF-7	2012	Star Mines	Wheel of Fortune	NQ	7			2,516
MT-1 to MT-13	2012	Star Mines	Monongahela surface (Virginius Vein)	NQ	13		8,540	
MT-14, MT-16, MT-17	2013	Star Mines	Monongahela surface (Virginius Vein)	NQ	2		2,772	
TR-1 to TR-17	2013	Star Mines	Terrible Vein surface	NQ	17		9,096	
Star				Total	70	33	29,864	12,197
OSM001 - OSM042	2016	OSMI	Monongahela Underground (Virginius Vein)			42		7,730

Hole Nos.	Date	Company	Location	Core	Number of Surface Holes	Number of UG Holes	Surface (ft)	UG (ft)
OSM043 - OSM052	2020	OSMI	Blue Grass Claim			10		8,161
OSMI				Total		52		15,840
Total by Drilling Type (Surface or Underground)				Total	161	351	54,653	100,990
Total Drilling				Total		512		155,643

Source: SRK based on OSMI information, 2021

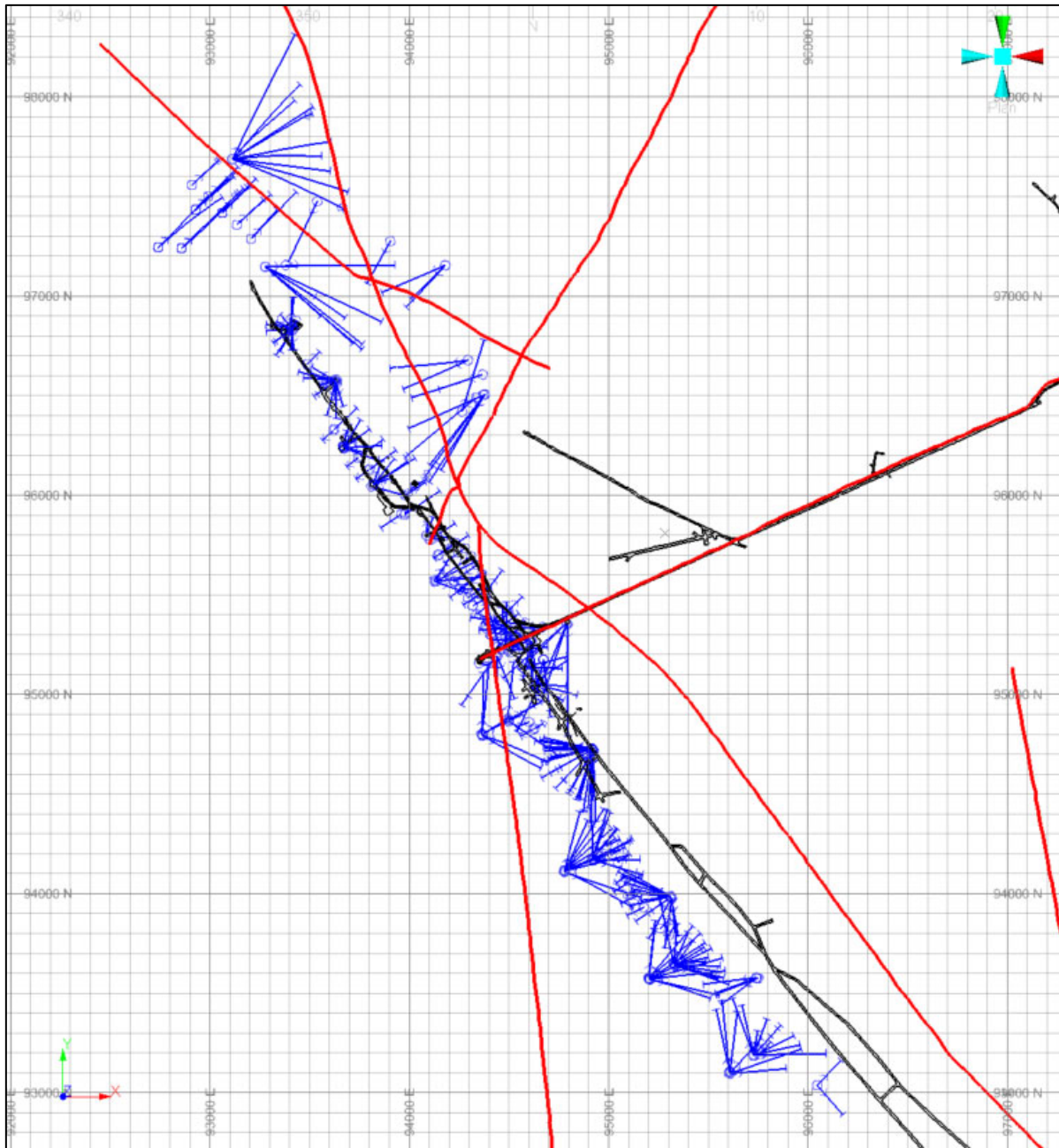

Source: SRK, 2017

Figure 10-1: Drillhole Traces (blue) Covering the Virginius, Footwall and Terrible Veins, Plotted Against Surface Trace of Veins (Red)

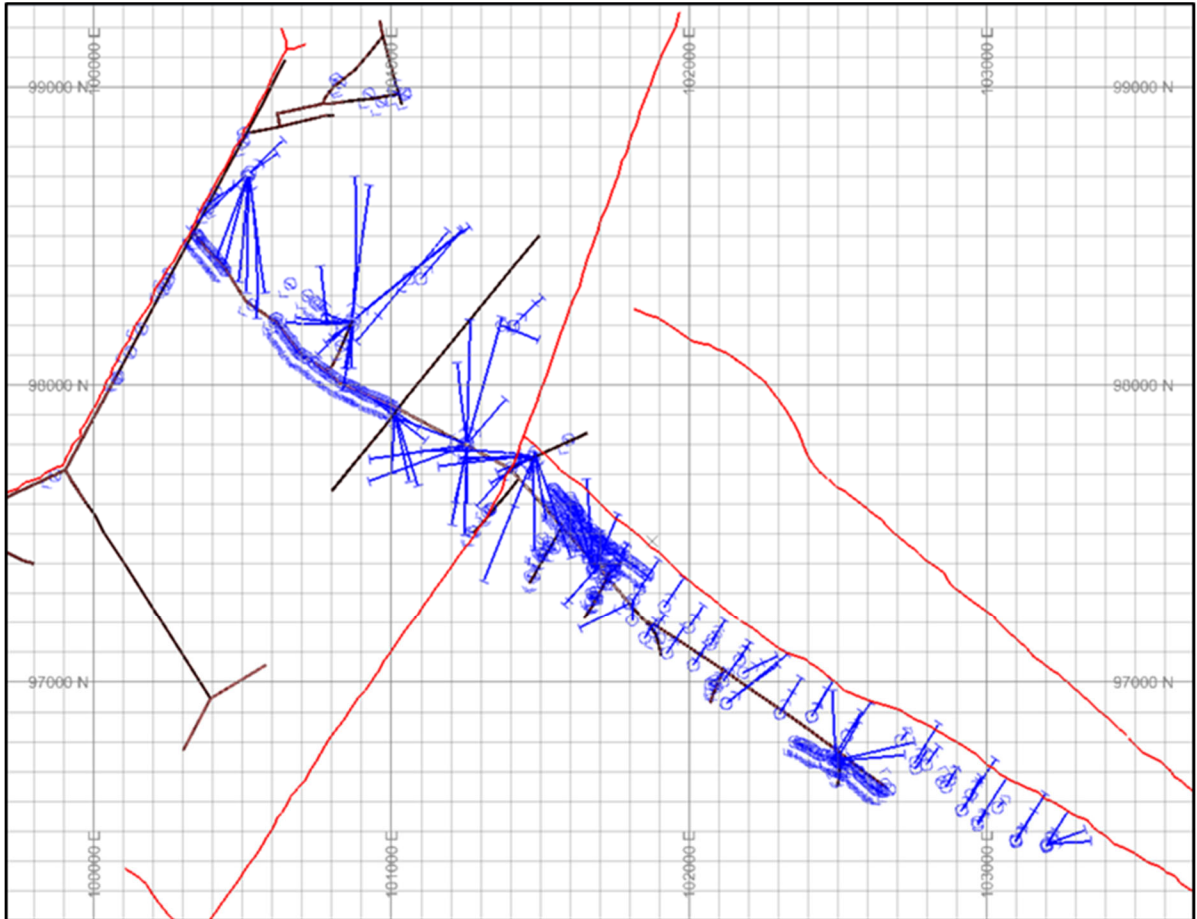

Source: SRK, 2017

Figure 10-2: Drillhole Traces (Blue) Covering the Yellow Rose Veins (Red)

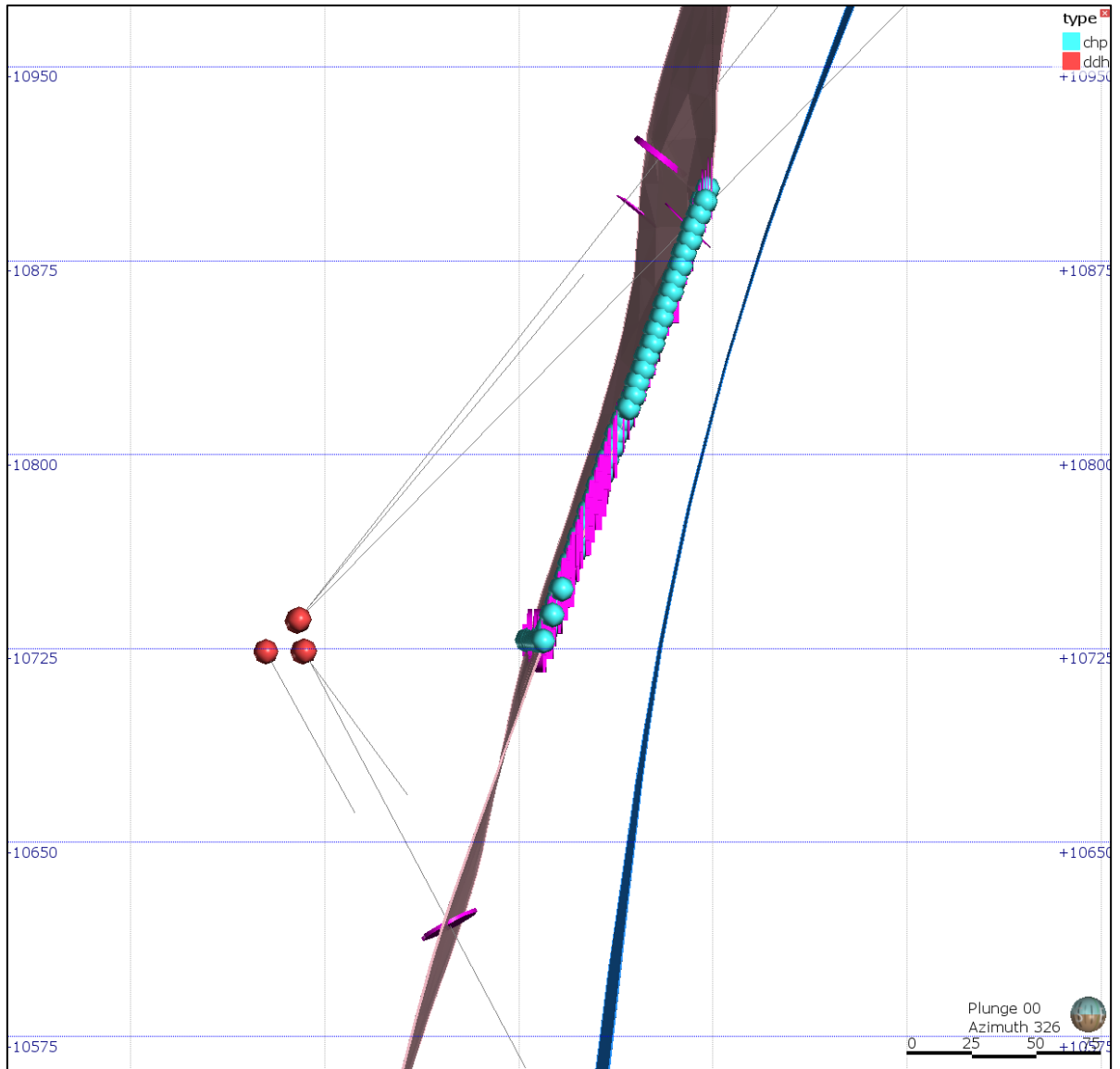

Source: SRK, 2017

Figure 10-3: Example of Cross Section Showing Interaction of Vein to Drilling Intersection

10.2 Procedures

10.2.1 Historic

Limited knowledge of the historical drilling and sampling procedures is known with the exception of information captured in the drilling logs (Figure 10-4), which included hole ID, hole location (XYZ), Bearing, Inclination, Depth, Hole Size, Driller, logger, and date. SRK has initially been supplied with scans of the historical logs, which have in turn been verified against the original logging sheets located at the mine. In general, the geological logs are informative, but contain most geological information in the form of detailed written descriptions, which makes use in an electronic database difficult. SRK has produced a series of quick logs of the data for the current estimation to utilize the geological information, but SRK recommends that work be completed to produce a complete geological database

including information on major geological units, minor geological units, evidence of geological structure, and core loss. No estimate of core recovery exists in the historical logging and, therefore, cannot be assessed.

RANCHERS EXPLORATION AND DEVELOPMENT CORPORATION

DRILL LOG *Hole Specimenized 4' every 4' sheet 1 of 2*

HOLE NO <i>RV-52</i>		PROJECT <i>75ft. W. in Thompson Ave Drift NW. below Revenue</i>		SEC. T. R.	COUNTY <i>Duray</i> STATE <i>Co.</i>	
DEPTH <i>126'</i>	BEARING <i>S 58° W</i>	INCLINATION <i>-52°</i>	COORDINATES <i>95,521.5' N. 94,386' E.</i>		ELEVATION <i>10,711'</i>	
HOLE SIZE <i>AGWL</i>		DRILLER <i>Thompson - Cannon</i>	Date Started <i>2-2-83</i>	Date Completed <i>2-3-83</i>	LOGGED BY <i>JRT</i>	DATE <i>2-3-83</i>

From-Ft	To-Ft	ALTERATION							Log	DESCRIPTION	Sample Number	From	To	Length	ASSAY DATA							
		% Fe	Ch	Ep	Rm	Py	Cy	Other							OZ Au	OZ Ag	% Pb	% Cu	% Zn	Other		
<i>0.0'</i>	<i>3.0'</i>									<i>Hole plugged N.P.C.</i>												
<i>3.0'</i>										<i>Sand - Juvial breccia mostly white to grey in color mostly med. broken core to 6" even likely broken throughout occasionally a hairline fract. ang. 45° - gty. fill</i>												
	<i>27.25'</i>									<i>26.6' - 27.85' med. chlorite alt. Dis. Fcs 27.5' - 27.85'</i>												
<i>27.85'</i>									<i>F.W.</i>	<i>Verm brecciated gty. with Py blocks of Phs. 45° H. Py Fcs</i>	<i>808</i>	<i>27.85'</i>	<i>28.2'</i>	<i>0.35'</i>	<i>.014</i>	<i>32.02</i>	<i>37.0</i>	<i>.31</i>	<i>.16</i>			
<i>28.2'</i>										<i>Tsj. form. breccia med. chlorite alt. & med. breaching likely fract'd</i>	<i>809</i>	<i>28.2'</i>	<i>30.55'</i>	<i>2.35'</i>	<i>.009</i>	<i>.64</i>	<i>.19</i>	<i>.08</i>	<i>.06</i>			
<i>30.55'</i>										<i>Dike + Verm</i>	<i>810</i>	<i>30.55'</i>	<i>32.4'</i>	<i>1.85'</i>	<i>.17</i>	<i>17.89</i>	<i>6.2</i>	<i>.27</i>	<i>.71</i>			
										<i>31.0' - 32.4' Verm 10' mostly gty. brecciated with w/ S2 au' gty. with heavy Sulfides Phs-Fcs and visible native silite 45°</i>												
	<i>33.0'</i>									<i>32.4' - 33.0' highly bleached and pyritized dike</i>												
<i>33.0'</i>										<i>Sand Juvial breccia bleached and chloritized occasional Ameline to 216" gty. str. 40°-50°</i>												
<i>55.7'</i>										<i>Dike typical grey-green 25° mostly likely fract'd - locally med. to h.gly broken as noted</i>												

Source: OSMI, 2015

Figure 10-4: Example of Historical Logging Sheets by Ranchers (1983)

10.2.2 Star Mines

All Star Mines drillhole collars were surveyed by Merritt Surveying, a local surveying firm. Any historical drillhole collars that could be positively identified have been surveyed. Holes that predate 2012 that cannot be located may vary from a few feet to 30 ft above or below the surface. These older holes were registered to the topography for modeling and resource estimation and showed acceptable correlation with Star Mines data. SRK previously recommended a focused effort to identify historical holes and check their collar elevations and survey locations. This effort was substantially completed by OSMI prior to this report in areas deemed crucial to the resource estimated and is ongoing for the remainder of the drillhole database. Further clarification of collar locations will be completed by OSMI once levels below the 2000 level are accessed.

Downhole surveys were completed by the drilling company using a REFLEX EZ SHOT tool provided by Core One. This is a magnetic downhole survey instrument. There are trace amounts of magnetite in the mineralization at a microscopic level. According to Star Mines, the amount of magnetite present has not affected the use of Brunton compasses or other magnetic instruments underground and there

have been no observed issues with using magnetic downhole survey instruments. The drillholes were surveyed at varying intervals along the hole and at the bottom of the hole.

Drill core was placed into waxed cardboard boxes directly from the core tube at the drill site. A wooden run-block was marked with the hole depth in feet and was placed in the core box upon completion of each drill run. The core was drilled with 10 ft tools for surface drilling and 5 ft for underground drilling. Core recovery was generally very good, and 100% core recovery is common. The core boxes were covered with a cardboard lid and then transported to the core logging facilities in Ouray. Core was typically delivered at the end of each shift, depending on productivity and weather conditions. Core was transported from the drill rig to the Revenue Portal by the drilling contractor.

After drilling, underground drillhole collars drilled by Star Mines were surveyed by site personnel and later checked by Merritt. Merritt set the surface control points for the Project, surveyed all surface drillholes drilled by Star Mines and locatable surface drillholes from previous operators. Merritt also surveyed accessible underground workings and drillholes that could be located on the Revenue Tunnel level.

10.2.3 OSMI

Drilling was completed in 2016 via existing exploration drives using a fan drilling pattern. SRK worked with OSMI in locating the holes and defining the drilling orientations to try to maximize the drilling coverage from the available locations. Figure 10-5 shows an example section through one of the drilling fans (looking northwest), which demonstrates the typical intersection angles achieved. SRK considers the current drilling is representative of the vein locations, with efforts made to avoid shallow intersection angles where possible.

All 2016 drillhole collars were surveyed by an OSMI surveyor. Downhole surveys were completed on the majority of drillholes by the drilling company using a REFLEX EZ SHOT tool. The Reflex EZ SHOT is a magnetic downhole survey instrument. There are trace amounts of magnetite in the mineralization, but not in significant quantities to interfere with surveying instruments. Downhole surveys were not completed in some of the drillholes due to tool availability and safety concerns with use of survey equipment in steep up-holes. The drillholes were surveyed at varying intervals along the hole and at the bottom of the hole. The drillholes which did receive downhole surveys did not show significant deviation from planned orientations.

Drill core was placed into waxed cardboard boxes directly from core barrel at the drill site. A wooden run-block was marked with the hole depth in feet and was placed in the core box upon completion of each drill run. The core was drilled with 5 ft intervals using triple tubes to minimize core loss. Core recovery was generally very good, and 100% core recovery is common, in some areas of broken ground core recovery was less but noted accordingly in the logging sheets. The core boxes were covered with a cardboard lid and then transported to the core logging facility on the surface by the drilling contractor. Core was typically delivered at the end of each shift, depending on productivity and rail access.

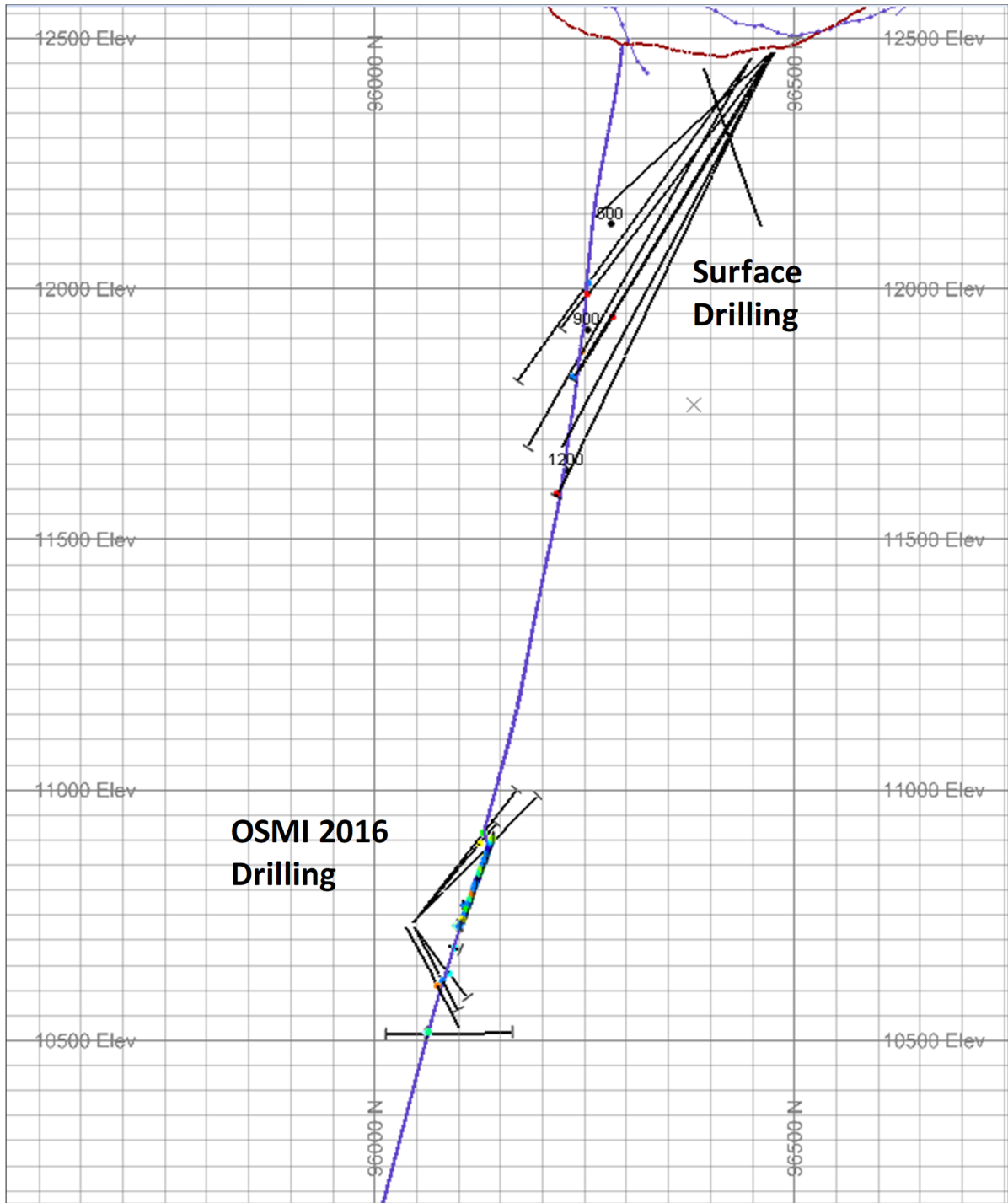

Source: SRK, 2018

Figure 10-5: Cross Section showing Example of OSMI Drilling Sections Relative to Vein

In July 2020 OMSI commenced initial exploration on the newly acquired Blue Grass Permit. The program consisted of 10 holes drilled from the hanging wall into the proposed extension of the Virginius vein northwest of the existing operating mine. The exploration procedures used the same process as the 2016 programs with the exception of the inclusion of independent QA/QC processes. A collar plot

of the 2020 drilling as reported by Aurcana is shown in Figure 10-6. The drilling targeted a drill spacing of approximately 150 ft in the upper portion, with spacing extending to 300 ft at depth.

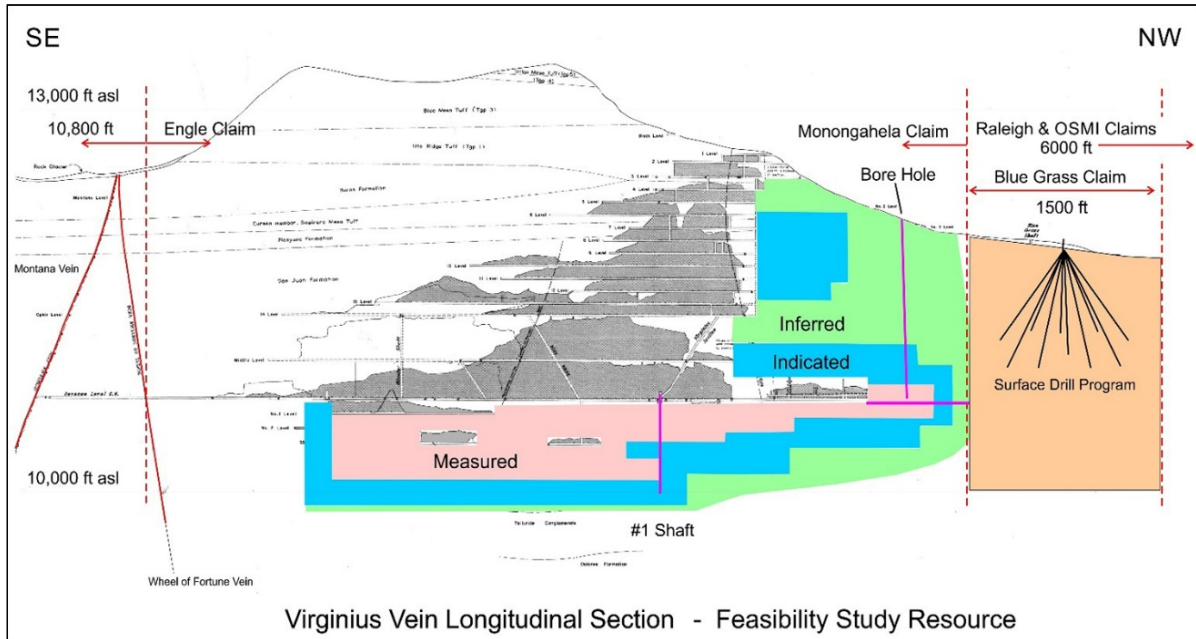

Source: OSMI, 2020

Figure 10-6: Collar (top) and Exploration (bottom) plan of Blue Grass Drilling, Dated July 23, 2020

10.3 Interpretation and Relevant Results

Drilling is conducted to intercept the veins as perpendicular as possible. Given the terrain and drilling access very few intercepts from surface are considered of true thickness. Drilling at the Virginius vein is best completed from underground to intercept the vein perpendicular to the vein dip. A summary of the intersections from the 2016 Drilling results is shown in Table 10-2.

The current process used by OSMI has been to utilize crosscuts and fan drilling patterns. One alternative would be to drive a footwall lateral (or hangingwall if required) drift from which drilling could be completed at more regular intervals, whilst ensuring intersections remain as perpendicular as possible.

Initial drilling of the Blue Grass claim was done with ten surface holes in 2020 the results were not conclusive and follow up drilling will be done in the future. More detailed exploration including detailed surface mapping, and structural review is needed to confirm the proposed theory that the Virginius vein extends along the length of the claim.

Table 10-2: Summary of Assays from 2016 OSMI Drilling Campaign

BHID	Count	Length (ft)	Au (opt)	Ag (opt)	Pb (%)	Cu (%)	Zn (%)
OSM-001	1	1.5	0.04	65.20	10.44	0.68	14.71
OSM-002	1	0.6	0.08	332.00	7.93	2.57	6.51
OSM-003	1	2.4	0.08	21.10	15.55	0.09	0.93
OSM-004	1	1.5	0.11	8.26	2.93	0.08	2.22
OSM-005	1	0.5	0.05	31.80	12.08	0.17	15.12
OSM-006	1	1.5	0.05	11.90	5.53	0.11	1.94
OSM-007	3	0.5	0.00	0.18	0.03	0.01	0.07
OSM-008	2	1.5	0.00	0.31	0.10	0.01	0.09
OSM-009	2	2.4	0.02	4.78	1.57	0.02	1.22
OSM-010	1	2.0	0.07	8.58	4.72	0.05	0.40
OSM-011	1	1.4	0.00	0.05	0.01	0.01	0.01
OSM-012	1	1.2	0.01	1.91	1.16	0.02	0.67
OSM-013	1	0.8	0.01	3.60	1.89	0.02	1.55
OSM-014	1	4.0	0.01	1.33	0.82	0.02	1.29
OSM-015	1	2.6	0.02	56.50	9.43	0.36	1.97
OSM-016	1	1.2	0.02	7.05	1.73	0.05	0.93
OSM-017	2	0.5	0.00	1.16	1.58	0.01	0.12
OSM-018	2	6.8	0.00	0.23	0.23	0.01	0.03
OSM-022	2	6.6	0.05	4.37	1.36	0.03	1.29
OSM-023	3	0.5	0.00	0.57	0.66	0.01	0.76
OSM-024	2	2.0	0.02	27.10	2.31	0.23	2.06
OSM-025	2	3.4	0.02	102.00	9.22	1.11	3.58
OSM-026	1	0.6	0.01	70.30	4.02	0.72	2.01
OSM-027	1	1.8	0.22	15.30	4.75	0.23	0.85
OSM-028	2	0.5	0.02	1.80	0.67	0.02	0.37
OSM-029	1	1.6	0.02	32.40	0.96	0.19	2.00
OSM-030	2	1.6	0.08	15.80	2.54	0.07	1.34
OSM-031	2	0.8	0.01	19.60	1.29	0.17	4.46
OSM-032	1	1.0	0.05	26.80	1.31	0.29	2.17
OSM-033	2	0.5	0.57	118.00	2.47	0.95	1.83
OSM-034	2	0.5	0.01	38.00	9.54	0.40	8.64
OSM-035	1	1.3	0.02	11.10	6.80	0.07	22.62
OSM-036	1	1.5	0.02	11.60	3.57	0.07	15.43
OSM-037	2	2.6	0.23	8.21	5.06	0.06	0.76
OSM-038	1	1.2	0.03	3.27	1.49	0.03	1.98
OSM-039	2	1.4	0.01	7.59	1.35	0.06	11.08
OSM-040	2	1.7	0.02	140.00	11.28	0.74	0.56
OSM-041	2	1.1	0.01	13.50	5.52	0.09	5.21
OSM-042	1	0.5	0.04	28.90	7.27	0.18	2.91
Grand Total	59	1.68	0.05	29.76	3.71	0.24	3.15

Source: SRK, 2018

11 Sample Preparation, Analysis and Security

11.1 Security Measures

11.1.1 Historical

Sample security, preparation and analysis by previous operators pre-dated public reporting under CIM guidelines. The work conducted by previous operators was done using industry practice of the time period. During historic operations, core and channel samples would have been moved from the drill site or collection site to the portal area and then shipped to the appropriate laboratory. Core was stored at the warehouse at the Revenue Tunnel portal and until Sunshine ended involvement with the Project in 2001, was controlled and secure. It is reported that the core warehouse at the Revenue Portal was broken into between 2001 and 2011 and approximately 30% of the historic core was lost through vandalism.

During the exploration completed by Star Mines, core was transported to the Star Mines facility in Ouray by either the contractor or Star Mines personnel. The core was then stored in a locked secure facility until it was logged and sampled. After sampling, samples were shipped via FedEx or UPS to ALS Global (ALS) in Reno, Nevada. All facilities supervision, technical program supervision, and core logging were carried out by employees of Star Mines.

After logging and sampling, the core boxes are stored at Star Mines' field office in Ouray in the warehouse or in locked steel cargo containers. After analysis, all sample pulps and rejects were shipped from ALS in Reno back to Ouray where they are stored in a locked weatherproof building.

11.1.2 OSMI

Sample security has been maintained by OSMI during the 2016 and most recent campaign. In 2016 Drill core has been transported from the underground rig to the portal on a daily basis, where it was reviewed by the Company geologist. Core is sealed in a locked room overnight and is stored at the core facility. A portion of the drilling core is also stored at OSMI warehouse facility in Ouray. After analysis, all sample pulps and rejects are shipped from the laboratory back to Ouray where they are stored in a locked weatherproof building. SRK considers the sample security and chain of custody to follow best practice.

11.2 Sample Preparation for Analysis

11.2.1 Historical

Core drilled by Federal Resources and Sunshine was initially logged by a company geologist. The geologists sampled vein intercepts and alteration associated with the vein. The geologist marked sample intervals on the core where a vein or mineralization was visible. The minimum sample interval was defined by the width of the vein. All samples were recorded on the drill log. Core was split in half lengthwise with one-half retained and one-half shipped to the assay laboratory for analysis. The half of the core not analyzed was retained at the warehouse. SRK does not know precisely how the core was split; however, during this time period, it was likely a manual splitter.

The core logging by Star and OSMI was completed at a small facility near the main mine access. The core facility was locked by the geologist at the end of each shift to ensure security. The main core storage facility is located at the current OSMI warehouse in Ouray. The core has been stored on pallets

and on racks and wrapped in plastic with the hole numbers marked. To log the core, each box in a drillhole was laid out in sequence on elevated racks in the core logging area of the warehouse. The core was examined for condition, missing core, and depth tag errors. Boxes were labeled for photographing with black felt tip pens including the hole number, depth, and box number. The core was then washed and photographed.

Geologic data was entered on a paper core logging form as the field geologists log the drill core on a log sheet that includes drillhole location, bearing, inclination and start and finish date. Other information includes core recovery, description of the core and sample from, to and length information. Within the logging section, a comprehensive description of lithology, structure, alteration, mineralization and veining was made by the field geologists.

Significant faults and zones of incompetent core are marked and entered in the log. Star Mines did not collect Rock Quality Designation (RQD) or other geotechnical data during its drilling programs.

Core recovery was recorded for each core run, which was every 5 ft for underground or 10 ft for surface holes. Rubble, re-drill, or slough recovered at the top of a core lift that was not in place is not counted as recovered core and was discarded. The core recovery data collected by the geologist was recorded in the drill log. Recovery is greater than 95% and up to 100%.

Star Mines' geologists sampled vein intercepts and alteration associated with the vein. Star Mines did not sample barren wall rock. The geologist marked sample intervals on the core where a vein or mineralization was visible. The minimum sample interval was defined by the width of the vein (ranging from 0.1 to 5 ft), with an average sampling length within the vein of 1.2 ft. All samples were recorded on the drill log. Sample data was subsequently entered into a sample spreadsheet. Sample numbers were assigned sequentially from sample tag books provided by Star Mines. Each sample has a unique sample number. A wooden block with the sample number was put into the core box at the top of each sample to provide a permanent record of the sample. The samples were sawed in half lengthwise with one half sent to the lab and the other half kept in the core box representing the interval. All samples were cut using a diamond saw. A printed sample tag was placed in the sample bag with each sample by core cutting personnel. All sampling was performed by Star Mines personnel under the supervision of the chief geologist.

All samples were packaged and shipped from Ouray via FedEx and UPS to ALS in Reno, Nevada, generally within five days of sample collection. ALS had ISO 17025:2005 accreditation for individual analytical methods and ISO 9001:2008 accreditation for quality management. ALS is a commercial laboratory which is independent to OSMI and no direct interest in the Project.

Individual samples were packed in rice bags sealed with duct tape. Samples were organized sequentially, in each rice bag with no more than ten samples per bag. Rice bags were labeled with the shipment number, bag number and total number of rice bags in the shipment. Each bag also had the sample number range included in the bag on a sheet of paper. A laboratory sample submittal form was filled out and emailed to the lab. Shipment information was recorded in a sample tracking spreadsheet.

11.2.2 OSMI

Drill core was logged by an OSMI geologist for both geological and geotechnical parameters. Geotechnical data was collected under the direction of SRK and included collection of recovery data by drill run for the entirety of the drilling, as well as run-based detailed geotechnical logging for the entirety of eight drillholes.

Geological logging was conducted on the entirety of all the holes with particular attention to mineralized veins and the “shoulder” regions on each side of the veins. Geologic data was entered into a digital spreadsheet as the field geologists logged the drill core. The log sheet includes drillhole location, bearing, inclination and start and finish date. Other information includes core recovery, description of the core and sample from, to and length information. Within the logging section, a comprehensive description of lithology, structure, alteration, mineralization and veining was made by the field geologists.

Sample intervals were selected by the Company Senior Geologist. Sampling was selected to have a maximum length of 4 ft. Vein samples were selected contact to contact and veins less than 0.5 ft included country rock to the 0.5 ft minimum. Shoulder samples consisted of a minimum of two 2 ft samples either side of the vein.

The core intervals sampled were marked by colored crayon, measured, assigned a unique identification number and recorded in a sampling record, which was included in the final drill log. These core intervals have been photographed prior to splitting.

Core drilled by OSMI was split in half lengthwise with one-half retained and one-half shipped to the assay laboratory for analysis. The other half of the core was retained at the warehouse. OSMI sample intervals have mainly been split by diamond saw, with the exception of samples that are severely fractured and friable. An OSMI senior geologist makes determination of the best method of splitting as necessary. Friable veins are susceptible to loss of economic mineralization and biased sampling. Where whole core sampling occurs, this has been noted with a summary description of the intersection and the reason for whole-core sampling included in the geological log.

Repeat analyses of certain core samples, selected by the geologist, consisted of a second assay on the original pulp. Blank samples and Certified Reference Materials (CRM) prepared by OSMI were inserted into the sample stream as determined by the geologist. The laboratory inserted CRM's and performed repeat analyses at their usual frequency.

11.3 Sample Analysis

11.3.1 Historical

Federal Resources utilized the Camp Bird Mine laboratory located at the Camp Bird Mine. Analytical work for any drilling completed between 1960 and 1970 would likely have been analyzed in that laboratory. SRK cannot confirm this and cannot confirm any accreditations held by the facility at the time. The Camp Bird laboratory conducted Fire Assay (FA) for precious metals and had the capability of analyzing copper, lead and zinc. SRK does not know the detection limits for these analyses at this laboratory.

Between 1980 and 1984, Ranchers used the following analytical laboratories, which are all commercial facilities and independent of the mine:

- Mountain States Research and Development (Mountain States) in Vail Arizona
- Root & Norton in Silverton, Colorado
- Union Assay Office, Inc. (Union Assay) in Salt Lake City, Utah
- Skyline Labs, Inc. (Skyline) in Wheat Ridge, Colorado

These laboratories analyzed precious metals by FA. Root & Norton report that FA was a one assay ton charge. None of the other labs distinguish whether FA was by 1 or 2 assay ton; copper, lead and zinc were likely by Atomic Absorption Spectroscopy (AAS). The lower detection limits for FA at Skyline and Root & Norton were 0.005 oz/st for gold and 0.01 oz/st for silver. Skyline reported a lower detection limit of 0.005% for copper and lead and 0.002% for zinc. Mountain States reported gold grades down to 0.001 oz/st and silver down to 0.05 oz/st but SRK is unsure if these are the lower detection limits. Neither Root & Norton nor Mountain States indicated what the lower detection limit for copper, lead and zinc were on their assay certificates.

Sunshine explored the Project between 1994 and 2001 and used Skyline for analytical work at the Project.

Star Mines submitted samples to ALS in Reno for analysis. On receipt at ALS, the sample bags were opened, sorted and dried prior to preparation. All samples were crushed to >70% passing 6 mm. The coarse-crushed material was then fine-crushed to 70% passing 2 mm and a Boyd Rotary Splitter was used to split a 1,000-gram (g) sample. The 1,000 g split was pulverized to 85% passing 75 micrometer (µm) (0.075 mm).

The samples were then analyzed by FA with a gravimetric finish for both gold and silver. This is ALS method ME-GRA22, which is analysis using a 50 g charge. The analytical range is 5 to 10,000 ppm for silver and 0.05 to 1,000 ppm for gold. Silver was also analyzed using Ag-GRA21, which is a 30 g charge, FA analysis with gravimetric finish if there was insufficient sample to run using a 50 g charge. The upper limit for this analytical method is 100 ppm. Star Mines also had a subsample analyzed using a 33-element geochemistry package that includes silver, copper, lead and zinc. This is ALS code ME-ICP61, and analysis is by Inductively Coupled Plasma-Atomic Emission Spectroscopy (ICP-AES) and four acid digestion. Table 11-1 lists the elements and detection limits for ALS method ME-ICP61. Over limit analytical results for silver, copper, lead and zinc using the geochemistry package were re-analyzed using ALS method OG62 for individual elements.

ALS shipped the pulps and rejects back to Star Mines, which are stored at the Company’s warehouse in Ouray.

Table 11-1: Elements and Upper and Lower Detection Limits for ALS Code ME-ICP61

Element	ppm	Element	ppm	Element	ppm
Ag	0.5-100	Fe	0.01-50%	S	0.01-10%
Al	0.01-50%	Ga	10-10,000	Sb	5-10,000
As	5-10,000	K	0.01-10%	Sc	1-10,000
Ba	10-10,000	La	10-10,000	Sr	1-10,000
Be	0.5-1,000	Mg	0.01-50%	Th	20-10,000
Bi	2-10,000	Mn	5-100,000	Ti	0.01-10%
Ca	0.01-50%	Mo	1-10,000	Tl	10,10,000
Cd	0.5-1,000	Na	0.01-10%	U	10-10,000
Co	1-10,000	Ni	1-10,000	V	1-10,000
Cr	1-10,000	P	10-10,000	W	10-10,000
Cu	1-10,000	Pb	2-10,000	Zn	2-10,000

Source: ALS Geochemistry, 2013
 Note: Limits are in ppm unless otherwise noted

11.3.2 OSMI

All samples from the OSMI 2016 exploration drilling program were dispatched to Skyline (which is independent of the mine) for preparation and analysis. Skyline laboratory is accredited in accordance with the recognized International Standard ISO/IES 17025:2017. This accreditation demonstrates technical competence for a defined scope and the operation of a laboratory quality management system. The Skyline quality management system has been certified as conforming to the requirements defined in the International Standard ISO 9001:2015.

Sample shipments to the laboratory consisted of every sample collected from the drilling program with priority batches sent for material with logged vein intersections and lower priority on batches taken from the shoulder of the vein.

The laboratory reported all analyses and QA/QC results in excel spreadsheets and Published Document Format (PDF) documents. Coarse rejects of all samples will be returned and stored on the mine site for future use. OSMI has selected two methods of analysis of the samples to enable a full suite of element data using suitable assay methods (a summary of the detection limits used is shown in Table 11-2).

Assay Procedure A - Each mineralized vein sample and specified repeats were analyzed by:

- 50 g charge fire assay for both gold and silver (Skyline method FA-3-50g)
- Multi-element analysis for copper, lead and zinc (Skyline method MEA)

Assay Procedure B - Each country rock sample, specified repeats and blank samples were analyzed by:

- 30 g charge fire assay for gold (Skyline method FA-1)
- Multi-element geochemical 32 element ICP-OES (Skyline method TE-2)

Table 11-2: Summary of Detection Limits and Laboratory Codes for OSMI Submissions

Element	Unit	Detection	Assay Code	Element	Unit	Detection	Assay Code
Au	oz/st	0.001	FA-01	K	%	0.01	TE-2
Ag	oz/st	0.10	FA-4	La	ppm	10	TE-2
Ag	ppm	0.2	TE-2	Mg	%	0.01	TE-2
Pb	ppm	2	TE-2	Mn	ppm	5	TE-2
Cu	ppm	1	TE-2	Mo	ppm	2	TE-2
Zn	ppm	1	TE-2	Na	%	0.01	TE-2
Al	%	0.01	TE-2	Ni	ppm	1	TE-2
As	ppm	5	TE-2	P	%	0.001	TE-2
Ba	ppm	10	TE-2	S	%	0.01	TE-2
Be	ppm	0.5	TE-2	Sb	ppm	5	TE-2
Bi	ppm	5	TE-2	Sc	ppm	0.1	TE-2
Ca	%	0.01	TE-2	Sr	ppm	1	TE-2
Cd	ppm	1	TE-2	Ti	%	0.01	TE-2
Co	ppm	1	TE-2	Tl	ppm	10	TE-2
Cr	ppm	1	TE-2	V	ppm	1	TE-2
Fe	%	0.01	TE-2	W	ppm	10	TE-2
Hg	ppm	1	TE-2	Zr	ppm	1	TE-2

Source: SRK, 2017

11.4 Quality Assurance/Quality Control Procedures

Historical QA/QC was not systematic and was only run to verify certain samples.

Star Mines completed a basic QA/QC program, which included reference materials (RMs), blanks and duplicate silver analysis. Star Mines did not insert any core duplicates during this period. Core duplicates are used to test the variability of a deposit and can be used to determine adequacy of sample size during preparation. SRK highlights, some of the historical drilling (pre-2000) in lower levels of the mine were mainly completed using NX or AQ diameter, which is less than ideal for the mineralization style. The use of channel sampling within the same areas has supported the current estimates, with further validation/analysis recommended once access is available.

In the 2021 drilling and production submissions no external QA/QC have been included. OSMI have relied on the results presented by Hazen laboratory to determine the quality of the assay information presented. While SRK considers the laboratory to be reputable, the current practices are not considered to be in line with Industry standard practice, and results in uncertainty in the laboratory results.

In accordance with the CIM Estimation of Mineral Resources and Mineral Reserves Best Practice Guidelines (2019), the following should be considered:

In general, a program of data collection should have quality control measures integrated into the normal sampling-subsampling analytical protocol. QA/QC protocols should include replicate analyses of appropriate standards and blanks and duplicate analyses of field samples, crushed sample material, and pulps. Regular monitoring of assays by an independent laboratory is considered as best practice. The results of the QA/QC program, a description of the pass/fail criteria, and the actions taken to address results that are outside of the pass/fail limits of the QA/QC program should be documented.

11.4.1 Standards

No standards were submitted for routine submissions prior to Star Mines. The Star Mines database was a limited dataset, and more RM measurements would have been required for a representative interpretation. The failures that occurred were in the low-grade silver RM and in the gold RMs. The silver failures were below the lower CoG for the mineralization and were not of concern. SRK previously noted that use of a RM closer to the lower CoG would be more appropriate.

In 2016, OSMI used 16 CRMs, eight high Ag grade (CRM 605) and eight low Ag grade (CRM 601) (Figure 11-1). The CRM samples have been inserted into the sample stream by the geologist, with 13 being included with vein submissions and three submissions taken from the shoulders of the vein. In addition to the OSMI CRM submissions OSMI has relied upon the laboratory CRM standards.

SRK was presented with copies from the laboratory certificates in electronic format and has extracted the information accordingly. The following provides a summary of the 2016 submissions of OSMI samples within the veins, which represents 13 submissions. The results have been reviewed, for all key elements and SRK has converted the assay values to the appropriate units (typically ppm) of the certification in each case. Overall, the samples reported within the two standard deviation limits which is deemed acceptable, but SRK highlights this is a relatively small data set and routine submission of OSMI. SRK recommends that CRM material should continue for future drilling and the routine underground sampling campaigns.

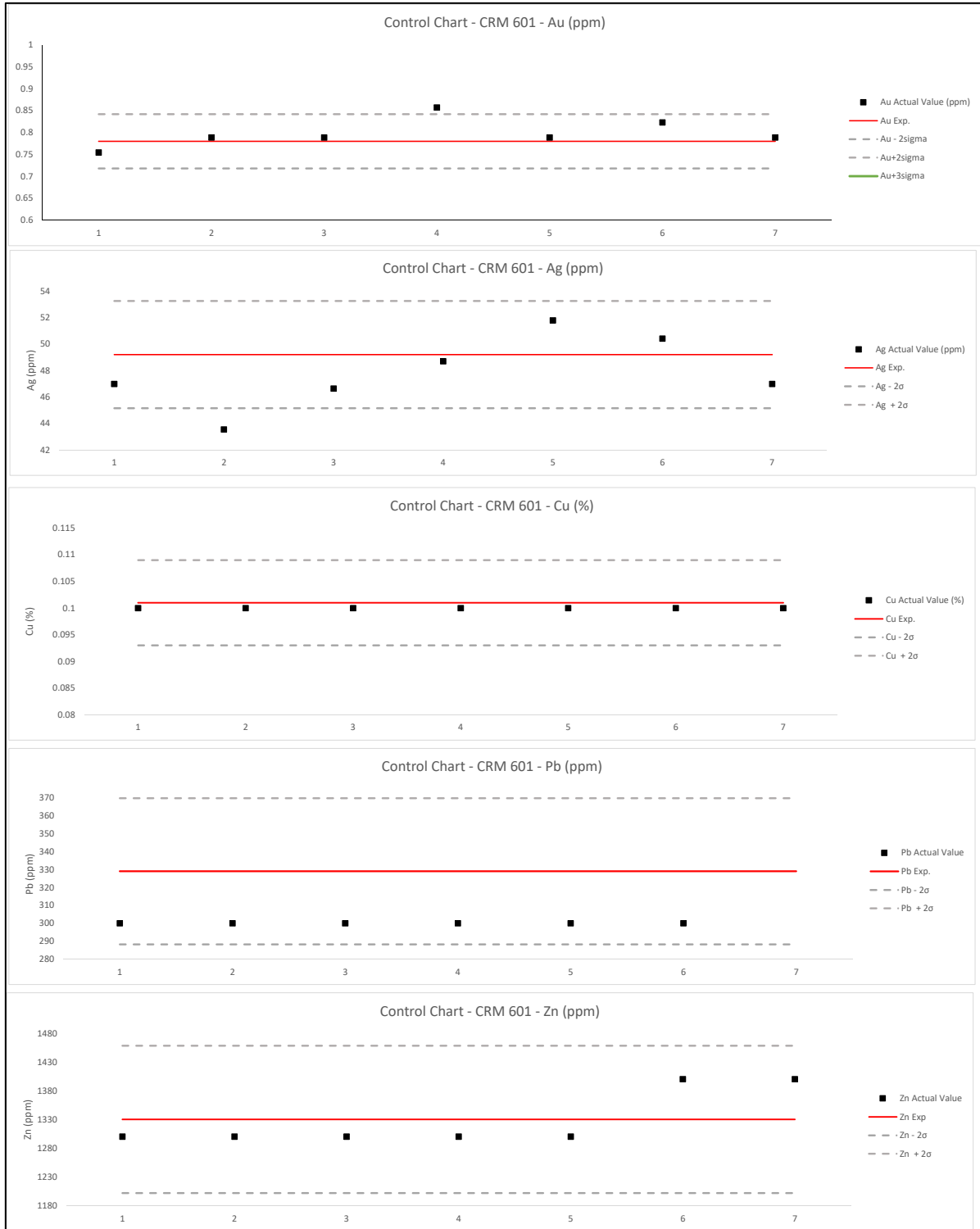

Source: SRK, 2016

Figure 11-1: Analysis of Assays for CRM 601 Submissions per Element

11.4.2 Blanks

No blanks we submitted in the historical sampling. Star Mines used a pulp blank from MEG during both 2012 and 2013. There were no failures in the blank submissions (Figure 11-2). OSMI has used pulp blanks during the 2016 campaign. Blank material was sources from intervals of unmineralized country rock. Only one sample has reported above a limit of 0.5 ppm Ag, which SRK does not consider a concern. Overall SRK considers there little to no evidence of contamination at Skyline during the 2016 submissions.

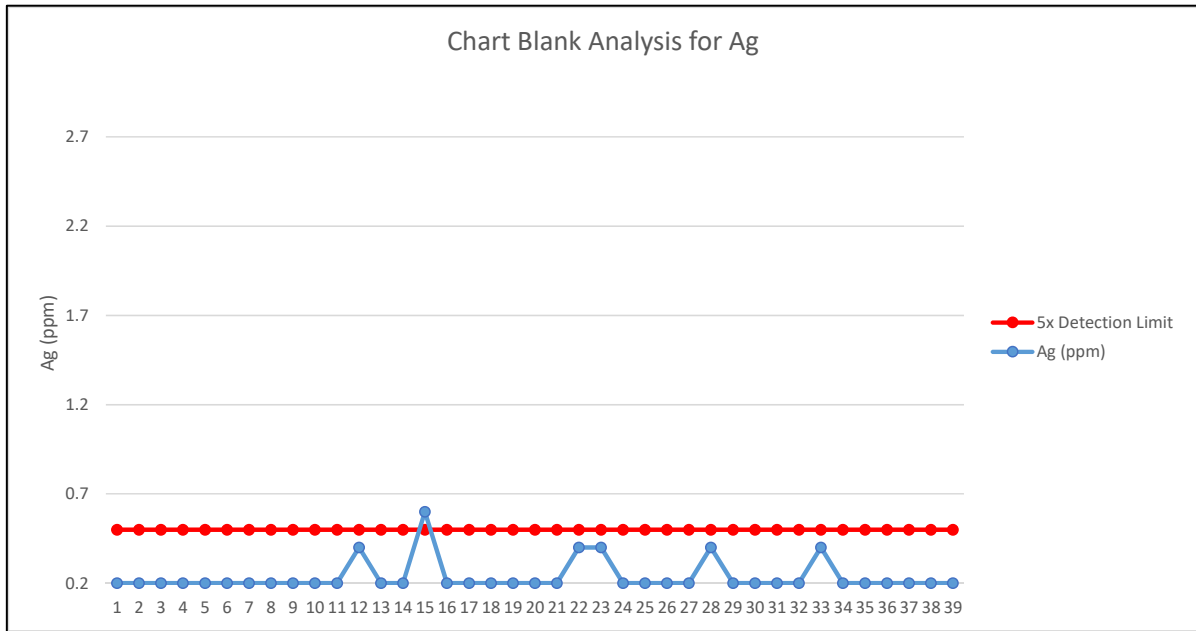

Source: SRK, 2016

Figure 11-2: Analysis of Blank Samples for Ag during 2016 OSMI Submissions

11.4.3 Duplicates

OSMI has requested repeat analyses on core samples, selected by the geologist, which consist of a second assay on the original pulp. The assay results have been reported in the original certificates from the laboratory as “CHK” assays. These samples only test the analytical precision as they are taken from pulps and do not demonstrate the full variability of the mineralization which would be expected to be higher. Given the size of the OSMI 2016 drilling program, the current practice is considered reasonable, but for future submissions SRK recommend including a coarse reject pulp to improve the confidence in the precision of the laboratory. This process has still not been completed in the current production and exploration program in 2020 (Blue Grass), with QA/QC reliant on the results presented as part of the laboratories internal QA/QC program

In 2016 SRK reviewed the results using basic statistics and XY scatter plots of the original versus the repeat assays. The results of the analysis for pulp repeats are shown in Table 11-3 and an example of the gold and silver XY scatter plots used is shown in Figure 11-3. The results from the investigation indicate a strong correlation between the original and repeat assays, which demonstrates a high precision within the laboratory analytical process.

Table 11-3: Summary of Duplicate Samples Submitted During 2016

Original	Au (oz/st)	Ag (oz/st)	Pb (%)	Cu (%)	Zn (%)
Mean	0.035	19.143	3.090	0.155	2.396
Standard Deviation	0.074	44.760	3.813	0.354	4.042
Sample Variance	0.005	2003.441	14.538	0.125	16.339
Range	0.568	331.950	15.545	2.565	22.615
Minimum	0.001	0.050	0.005	0.005	0.005
Maximum	0.568	332.000	15.550	2.570	22.620
Sum	2.668	1474.030	237.910	11.940	184.510
Count	77	77	77	77	77
Repeat	Au (oz/st)	Ag (oz/st)	Pb (%)	Cu (%)	Zn (%)
Mean	0.035	19.340	3.097	0.155	2.397
Standard Deviation	0.075	45.310	3.820	0.352	4.035
Sample Variance	0.006	2053.025	14.595	0.124	16.282
Range	0.584	335.950	15.545	2.545	22.375
Minimum	0.001	0.050	0.005	0.005	0.005
Maximum	0.584	336.000	15.550	2.550	22.380
Sum	2.690	1489.160	238.440	11.900	184.570
Count	77	77	77	77	77

Source: SRK, 2016

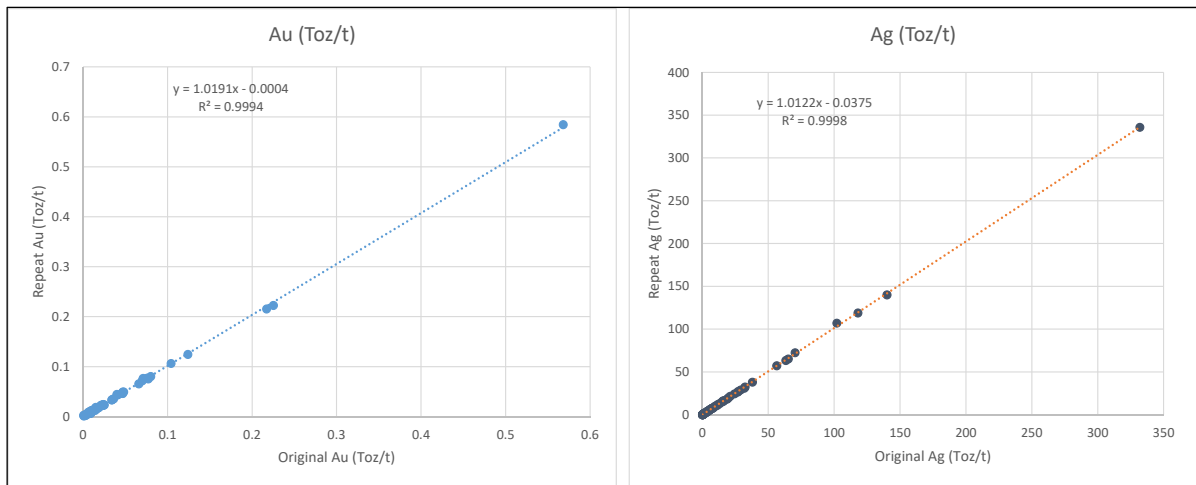

Source: SRK, 2016

Figure 11-3: Example of XY Scatter Chart to Compare Original to Repeat Assays

11.5 Opinion on Adequacy

SRK comments that the majority of the data used in the Mineral Resource pre-dates requirements for insertion of QA/QC common with JORC and CIM guidelines. The use of historical data has a degree of risk but given the long production history at the mine over various periods of time SRK has accepted that the drilling and sampling methodology are suitable for use in the geological modelling, and Mineral Resource estimate.

All drilling completed by Star Mines and the 2016 OSMI campaign included independent QA/QC and have been deemed acceptable for use in the Mineral Resource estimate. SRK has reviewed the sampling procedures for the diamond drilling, and underground sampling programs and considers them broadly in line with Industry standard practices with the exception that no independent QA/QC was completed for the 2020 drilling and 2021 sampling campaigns.

SRK does not consider this to be in line with industry standard practice. Due to a lack of uncertainty over the assays as no independent QA/QC was completed these assays have been excluded from the current update. SRK recommends that sample pulps from these campaigns are collected and reassayed with the inclusion of an industry standard QA/QC protocol. The results of this analysis could be integrated into future mineral resource updates. The QA/QC program should include CRM's, blanks and duplicate assays.

OSMI has an established chain of custody to ensure sample security from the drilling rig to submission to the laboratory. SRK is of the opinion that the sampling and analytical methods employed at the time of sampling and analysis followed industry standard protocols. Drilling on the lower levels have a relatively narrow core diameter, which may require verification sampling/drilling once access can be gained to the lower levels of the mine.

The values displayed on a long section, when reviewed over close spacing, result in a highly variable (nuggetty) style deposit. It is for this reason that historically the mining methods have been to mine using large panels, which result in a more average grade for the deposit as it accounts for the internal variance within the panels.

SRK considers the database to be of sufficient quality for use as the basis for the current MRE.

12 Data Verification

12.1 Validation Process

In 2014 SRK reviewed 10% of the database of both historical and new data against assay certificates and found less than 2% error in the database. Errors identified, at that time, were corrected in the database. No major changes were made to the assay database except where OSMI geologists averaged samples that had multiple assays.

SRK has completed a detailed review of the historical logging to gain more geological information. The geologic data had been entered on a paper core logging form as the field geologists/technicians originally logged the drill core. The log sheet includes drillhole location, bearing, inclination and start and finish date. Other information includes a description of the core and sample from, to and length information. Within the logging section, a comprehensive description of lithology, structure, alteration, mineralization and veining was made by the field geologists. Historical logs have been located both in hard and electronic copies.

SRK noted that the logging in general was descriptive which did not provide ease for capture into a modern geological database, as the use of major, minor geological columns, alteration styles, and key structures cannot be visually noted without the detailed reading of the geological logging.

In 2016 OSMI made the decision to focus on further validation of the geological database and review the historical logs in more detail. OSMI completed an internal review of the database versus the historical logging. To complete the review OSMI read through all the detail of the historical logs (detailed descriptions) and created the relevant logging codes in a standardized format. During the review, it was noted that some of the silver assays in the final database used an average of both FA and ICP measurements. It is believed that the FA will produce the most accurate assays and therefore OSMI has updated the raw database to reflect this change.

The validation work initially focused on the drilling in the upper 2210 and 2350 levels of the Virginius Vein where short term mining targets existed but has subsequently been expanded to the entire drilling database. During the review OSMI generated a new series of logging codes to identify the main mineralization structures. Using the logging codes SRK has identified the main mineralization structures under the following categories:

- V1: Virginius Main Vein, which has been simplified to identify the main grade bearing structure
- FW: Virginius Footwall Vein
- Terrible: Terrible Vein
- Yellow Rose: Yellow Rose Vein

In addition to recapturing the Yellow Rose assays, Star Mines previously provided additional copper data for the Yellow Rose area from subsequently located historical data. However, the first pass validation identified greater than 10% error in data entry for the copper analytical data. As part of the on-going validation OSMI staff reviewed and corrected all the assays in the database, which was limited to averaging grades where multiple assays had been taken.

Additional validation work completed by OSMI, and reviewed by SRK during 2016-2017, includes:

- OSMI commissioned Robert Larson to review the historical plans and update a digital survey of the historical development, including re-establishing the mine grid origins

- OSMI commissioned an on-going survey of all available development using modern digital methods
- SRK reviewed the collar information versus the current topography and noted some discrepancies, which were corrected and reviewed with OSMI staff
- SRK made an adjustment to one downhole survey which was assumed to be a potential rounding error. The revised geology provided a smoother interpretation and avoided a “pulling point” in the geological model, which was felt to overstate the potential vein thickness
- Borehole M-03 has been removed from the estimation process as it intersects the “jump-off dike” and does not intersect the Virginus Vein

In 2021 OSMI began production again and started taking underground production samples on a routine basis. As discussed in Section 9.2.3 of this report, SRK has identified a limitation to be able to use these samples as part of the current estimation process, including a lack of QA/QC process.

SRK has considered there to be value in completing a basic comparison of grade estimates using the validated 2017 database compared against the 2021 production database. To complete the exercise SRK performed the following tasks:

- Created sample points from the production data to allow compatibility with the formatting of the current 2017 ERM database;
- The created data points were combined with the 2017 database, and the estimates rerun for comparison. This data was generated by the estimation process presented in Section 14 of this report and the tonnage factor from the 2017 database.
- SRK has not updated the geological model to reflect the new vein widths but has focused on the grade variations generated by the above exercise.
- The block models were then coded by the 2021 stope designs and the grades compared.

SRK reviewed the results and has made the following conclusions from the above-mentioned comparison. However, it should be noted that the data set is limited and represents only 5% of total material in the stope. Grade variations and vein widths within and between stopes are expected with the assigned grades in the mine plan over the complete stope. The production sampling occurred at the 1800 level and the 2000 level test stope. The most significant variations noted occurred on the 1800 level. SRK noted local variations between the two stopes on the 1800 Level with the largest variations noted to occur within the l1800_s1080n_0580n stope which has reduced the current grades in this area in order of -50%. However the l1800_s1080n_1830n shows an increase of +22% in the grades, which offsets some of the differences. It is SRK’s opinion this highlights the type of local variability that can be expected within individual stopes.

Comparison of the vein thickness is considered reasonable between the sampling and the 2017 wireframe, although local variations in the spatial location are expected. Although the overall, the comparison of the mine plan from the current production sampling is in the order of 2 to 3% lower grades than estimated in the 2017 block model, it is SRK opinion this is to be expected based on the type of deposit.

SRK considers this to highlight the need for more infill drilling to better predict the grade variability. Minor changes to the production sampling protocol with the inclusion of QA/QC, could offset some of the need for additional drill data points to upgrade the confidence in the estimates.

12.2 OSMI Short term Models

OSMI are currently developing a process to generate a short term planning model for the deposit. To date the work has focused on the integration of the production data with the existing underground channel sampling and drilling information. A summary of the process is described below:

- Geological mapping is completed on a round by round basis with the hangingwall and footwall contacts, these contacts are digitized into Maptek Vulcan for later use (Figure 12-1). Mapping includes details on the dip and strike of the veins.
- Sampling is completed following the underground production data procedures in both the face and the back of the development
- Sampling points are reconciled to underground survey points
- OSMI have engaged Maptek to assist in the development of a process to generate geological models and block estimates
- The geological model uses the initial 3D location to generate a vein model using a combination of the production samples and mapping data
- Local structures such as the Jump of Dike and Jump of Dike Splay are integrated into the process
- The model creates a vein interpretation with the sampling placed in the center (with sample lengths representing the distance between development rounds)
- Final locations are reconciled to underground as-builts once survey is completed to ensure positioning is correct. If errors are noted the senior geologist makes the necessary edits to the database and interpretation.
- Block grades are then estimated by converting the sampling information to point data using the mid-point of each sample
- Final block grades and volumes are then used to generate production statistics for tonnages and grades on a local basis.

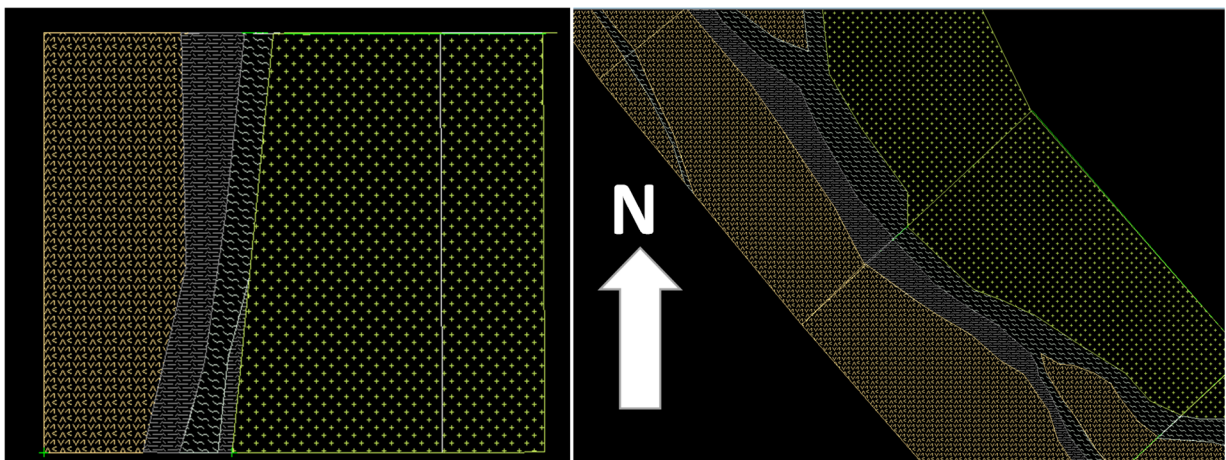

Source: OSMI, 2022

Figure 12-1 Example of face mapping (left) and back mapping (right) as captured in Maptek Vulcan.

SRK considers the use of a short term model to be industry best practice and comments that OSMI are putting procedures in place to achieve these goals. The current scale of the sampling is limited to the 1800 level stopes, but this process should continue as new areas of the mine open up and new stopes are available. Once sufficient information is available it can be compared to the current long-term models to optimize future estimates and improve confidence in the estimates ahead of the mining face.

12.3 Limitations

During the first pass of the 2015 geological modelling, SRK used the lithology as the primary selection for the interpretation. Upon completion a more detailed review of the wireframes indicated that the underground channel sampling, which represents a significant portion of the database, had not been logged using the same geological coding as the drilling database, which led to issues in developing the geological model. SRK accounted for these intervals in the current estimate by assigning manual interpretations of the hangingwall and footwall contacts. SRK considers there to be some risk of local variations, but SRK has attempted to limit this during the manual interpretation. To resolve the issue where lithology had not been logged, identification where possible of the lithological codes would improve the ability to model sub-units.

During the review of the historical information, SRK noted the absence of a portion of the historical channel sampling information on the 2210 level of the mine. The 2210 level have been recorded on a series of mapping sheets (three in total), with separate series for geology and assay information. OSMI located all maps with the exception of the assay information from the most northern portions of the mine. The risk of no assaying information has been limited to a degree as the most recent drilling has targeted this area, but additional sampling information may benefit in providing more robust estimates of the mean grades in these areas.

SRK completed a statistical review of the channel and drilling database which supports the use of both the chip and drilling samples. In general, the channel samples report higher grades than the drilling. Drill core sample lengths are 40% longer than the channel sample lengths which is a function of diamond drilling at angles through the mineralization, as opposed to channel samples that were perpendicular to the strike of the mineralization.

SRK has also noted the use of channel sampling for accurate placement of the mineralization has a degree of uncertainty due to different survey datums being used during different periods of the mining at Virginius. OSMI completed an independent survey of the mine which tied back to the newly validated positions. SRK recommends that OSMI continue their review all the XY positions of the collars primarily for the underground sampling but also for the drill collars when access is available.

12.4 Opinion on Data Adequacy

Overall SRK is satisfied that during the validation process any changes in location to the vein will likely be localized and not result in any material changes.

Local variability may be further explained by a greater understanding of the structural setting within the vein, as a number of known key geological features are discussed in historical reports but are not represented in three dimensions due to a lack of collated data at present.

A review of the current underground production information suggests the vein flexes further to the southwest than currently interpreted and may exist up to 20 – 30 ft from the current block locations. It is SRK view that integration of the underground structures would increase the understanding in the current vein models, which should involve a focused structural geological review of the project for both large scale (mine scale), and local scale (stope) variations. A review of the thickness in the current geological model and production information shows the current thickness provide a reasonable correlation.

Given the lack of independent QA/QC sampling, and the uncertainty in the underground production assay, SRK used the combined 2016 diamond drilling and underground sampling databases as validated in 2017 within the current estimate.

There remains a degree of risk given the historical nature of the channel sampling and the narrow core diameters used in the drilling at the lower levels below the 2000 level of the mine. It is difficult, at present, to equate the level of risk, as the majority of the channels have been taken within the higher-grade precious metal zones, compared to the majority of the drilling being at lower levels with lower precious metal values, but increased base metal values. SRK notes the following in terms of the current database:

- OSMI has an established production history with the average grades noted in the sampling comparing favorable to production
- The majority of the mineralization within the Monongahela area has been drilled using diamond drilling
- Sampling within the F9 stope confirms dip continuity in grades between levels

SRK is of the opinion that there remains no material bias is being introduced by using the 2017 database as presented by OSMI, and that it is adequate for use in the geological modelling and Mineral Resource estimation.

SRK is of the opinion that with minor modifications to the 2021 sampling protocol to include the introduction of QA/QC submission with the routine process is recommended. This minor modifications would add significant value to OSMI and its ability to prepare short term planning models which can be used to monitor the accuracy of the current estimate.

13 Metallurgy

13.1 Introduction

On behalf of OSMI, SRK designed and supervised both prefeasibility-level and feasibility-level metallurgical development programs for the Revenue-Virginius Project. The prefeasibility-level metallurgical program was fully documented in SRK's PFS report. The results of the feasibility-level metallurgical program are detailed in this FS report. The key results from the PFS metallurgical program are also presented in this report. Both metallurgical programs were conducted by FLSmidth USA, Inc. (previously Dawson Metallurgical Laboratory). The PFS metallurgical program was conducted on a bulk 1-ton master composite representing the Virginius Main Vein and on variability composites characteristic of the Virginius Hanging Wall Vein, and the Yellow Rose Vein. The FS metallurgical program was conducted on a master composite formulated to represent the weighted average ore contribution from the various mining areas of the mine and on five variability composites representing ore from selected areas of the Virginius Main Vein, Footwall vein and the Yellow Rose Vein. The ore is a complex polymetallic containing gold, silver, lead, copper and zinc. Silver is the metal of primary importance and is associated primarily with the copper mineralization (tetrahedrite and polybasite).

13.2 Prefeasibility Metallurgical Program

The objective of the PFS metallurgical program was to define the process parameters required to maximize metal recovery into separate lead and zinc flotation concentrates. The main scope of the metallurgical program included the following:

- Comminution and abrasion index determinations
- Differential Pb-Cu-Ag and Zn rougher/scavenger flotation studies
- Cleaner flotation studies
- Lead/copper separations studies
- Locked-cycle flotation testwork
- Tailing thickener tests
- Tailing pressure filtration testwork (dry stack tailings disposal)
- Concentrate thickening and pressure filtration tests
- Final concentrate characterization

13.2.1 Test Sample Characterization

Prefeasibility-level metallurgical studies were conducted on a master composite, characteristic of the Virginius Main Vein and three variability composites. The Virginius Main master composite was formulated from ore and waste rock shot out from an overhead pillar in Stope 231 to represent ore grades that would likely be achieved using the rescue mining technique in which at that time 40% dilution was anticipated (as described in the mining portion of this report, for average vein widths of 18 inches of width, dilution was found to be about half or less than 20% for the rescue mining method).

The three variability composites were formulated to be characteristic of the Virginius Main Vein, using the shrinkage stope mining technique in which 60% dilution is anticipated, the Virginius Hanging Wall Vein and a blend of the Yellow Rose and Virginius Main Veins. Ore representing the Yellow Rose Vein was formulated from available ½ core. Table 13-1 shows the head assays of the master composite

and variability composites that were developed for the PFS metallurgical program and the blending strategy that was used to formulate each composite.

Table 13-1: Head Analyses for Master and Variability Composites

Composites	Composite Type	Composite Blend	Ag	Au	Pb	Cu	Zn	Fe	S ⁻	S(tot)
			(oz/st)		(%)					
Virginus Master (VM)	Master	60% ore: 40% waste	30.0	0.008	5.36	0.35	0.60	5.40	2.18	2.24
Virginus High Dilution	Variability	40% ore: 60% waste	21.7	0.004	3.79	0.24	0.40	5.53	1.56	1.74
Yellow Rose Blend	Variability	25% VM: 75% YR	28.5	0.013	4.74	0.28	0.96	4.57	3.10	3.42
Hanging Wall	Variability	100% Hanging Wall	10.0	0.011	1.49	0.14	1.32	5.46	2.25	2.31

Source: FLSmidth, 2016

13.2.2 Mineralogical Analyses

Representative sub-samples of the Master composite, Hanging Wall variability composite and Yellow Rose Blend variability composite were examined by x-ray diffraction (XRD) and automated mineral analysis (AMA) for mineralogy, locking/liberation analyses and trace mineral detection. The results of this work are presented in FLSmidth’s report, “Mineralogical Characterization of Composite Samples from Ouray Revenue Mine and Flotation Concentrates from FLSmidth Locked-Cycle Testing”, June 14, 2016. The minerals detected and their concentrations in each composite are shown in Table 13-2. Lead was found to occur as galena, zinc was found to occur as sphalerite and copper was found to occur primarily as chalcopyrite and tetrahedrite. Tetrahedrite was identified as the primary silver-bearing mineral in the Virginus Master composite and the Yellow Rose Blend variability composite. Polybasite was identified as the primary silver-bearing mineral in the Hanging Wall variability composite. Tetrahedrite was found to contain about 12% silver and polybasite was found to contain almost 60% silver.

Table 13-2: Mineralogical Composition of Test Composites by QEMSCAN Analyses

Item	Virginius Master Composite (%)	Hanging Wall Variability Composite (%)	Yellow Rose Blend Variability Composite (%)
Chalcopyrite	0.56	0.38	0.35
Tetrahedrite	0.8	0.02	0.74
Other (Cu) ⁽¹⁾	0.03	0.04	0.01
Galena	6.60	1.44	5.80
Sphalerite	0.73	1.59	1.36
Pyrite	1.85	3.22	3.79
Arsenopyrite	0.01	0.06	0.01
Polybasite	0.01	0.04	0.02
Quartz	30.4	46.5	38.9
K-Feldspar	9.29	4.26	7.09
Plagioclase	6.48	2.60	4.68
Muscovite	17.6	20.7	16.4
Chlorite	10.0	3.61	7.24
Smectite & Kaolinite	1.41	1.46	1.12
Amphibole & Pyroxene	0.09	0.01	0.07
Calcite & Dolomite	6.55	5.80	4.67
Rhodochrosite	4.54	4.83	3.55
Siderite	0.49	0.94	0.37
Iron Oxide	1.15	1.32	0.95
Rutile/Ilmenite	0.35	0.34	0.38
Apatite	0.17	0.24	0.18
Epidote	0.13	0.03	0.08
Rhodonite	0.00	0.05	0.02
Barite	0.13	0.11	1.82
Other ⁽²⁾	0.59	0.32	0.41

Source: FLSmidth, 2016

¹Copper sulfides, phosphates, oxides and silicates

²Grouping of ultra-trace concentrations of silicates, sulfides and oxides

13.2.3 Comminution Studies

Bond Low Energy Impact tests (CWi) and abrasion index (Ai) determinations were conducted on ore and waste samples from the Virginius Main Vein. The results of these tests are summarized in Table 13-3. The Virginius Main ore sample had a reported CWi of 6.1 kWh/st and the waste sample had a CWi of 14.4 kWh/st. The ore sample Ai was reported at 0.267 indicating that the ore is abrasive and high wear rates can be anticipated. The waste sample Ai was reported at 0.057, which is considered lightly abrasive. Additionally, the specific gravity of the ore sample was measured at 2.91 and the waste sample was measured at 2.73.

Table 13-3: Bond Low Energy Impact and Abrasion Tests on Virginius Main Ore and Waste Samples

Sample	CWi (kWh/st)	Ai	SG
Virginius Main Ore	6.1	0.267	2.91
Virginius Main Waste	14.4	0.057	2.73

Source: FLSmidth, 2016

As shown in Table 13-4 the Bond rod mill work index (RWi) was measured at 15.08 kWh/st for the Virginius Master composite using a 1,180 µm closing screen. The Bond ball mill work index (BWi) was determined for the Virginius Master composite and the three variability composites using a 150 µm closing screen and was found to range from 14.9 kWh/st for the Yellow Rose/Virginius Master blend variability composite to 17.2 kWh/st for the Virginius high dilution variability composite. These results indicate that ore is medium-hard.

Table 13-4: Bond Rod Mill (RWi) and Ball Mill (BWt) Determinations

Composite	RWi kWh/st	BWt kWh/st
Virginius Main Master	15.1	16.3
Virginius High Dilution Variability		17.2
Yellow Rose Blend Variability		14.9
Hanging Wall Variability		16.4

Source: FLSmidth, 2016

13.2.4 Metallurgical Testwork – Master Composite

Metallurgical studies were conducted on the Virginius Main Master Composite and included a detailed evaluation of process parameters to recover silver, gold, lead, zinc and copper values by differential flotation using a process flowsheet that includes crushing, grinding, lead/copper/silver flotation followed by zinc flotation. Lead-copper separation from the lead/copper concentrate was evaluated in an effort to make separate silver- and gold-bearing lead, copper, and zinc flotation concentrates. The results of this led to the decision not to incorporate a lead-copper separation circuit in the flowsheet, and as such, the results of this work are not presented in this report. Testwork on the Virginius master composite was followed by confirmatory open circuit and locked-cycle testing on each of the of the variability composites using optimized test conditions established for the Virginius master composite.

Reagent Dosage Matrix

A reagent dosage matrix test series was run to evaluate various reagents and dosages during lead and zinc rougher flotation. For this test series, a target primary grind size of 80% passing (P₈₀) 106 µm was selected. During lead flotation, various dosages of sodium metabisulfite (MBS) and zinc sulfate were evaluated as zinc mineral depressants, and various dosages of 3418A (dialkyl-dithiophosphate), 242 (diaryl-dithiophosphate) and 3477 (diisobutyl-dithiophosphate) were evaluated as lead/silver/copper collectors. Following lead flotation, the pH of the lead flotation tailing was adjusted to 11.5 – 11.9 with lime and various dosages of copper sulfate were added to activate the zinc minerals (sphalerite). This was followed by the addition of various dosages of sodium ethyl xanthate and sodium isopropyl xanthate (SIPX) as zinc mineral collectors.

This test series indicated that zinc mineral suppression during lead rougher flotation was maximized with the addition of MBS and zinc sulfate in combination at dosages of 0.5 lb/st for each reagent. The addition of 3418A and 242 at 0.015 lb/st and 0.01 lb/st resulted in the recovery of 96.6% of the silver, 53.7% of the gold, 97.6% of the lead, and 96.7% of the copper into a lead rougher concentrate containing 285 oz/st silver and 46.4% lead. Approximately 36% of the zinc reported to the lead rougher concentrate.

Depending upon the copper sulfate dosage, it was found that about 40% to 44% of the zinc and 15% to 24% of the remaining gold could be recovered into a zinc rougher concentrate containing 6.4% to 7.8% Zn and 0.02 to 0.06 oz/st Au. Overall, silver and gold recovery into the lead and zinc rougher concentrates was 97.2% and 77.3%, respectively.

Grind Recovery and Cyanide Addition Test Series

A test series was conducted to evaluate metal recovery during lead and zinc rougher flotation versus grind size, as well as the effect of cyanide addition as an aid to zinc mineral depression during lead flotation. Grind sizes over the range from P80 70 to 160 µm were evaluated without the use of sodium cyanide. Cyanide additions of 0.01, 0.02 and 0.03 lb/st NaCN were evaluated at a grind size of P80

95 µm. The results of these tests are summarized in Table 13-5 and shown graphically in Figure 13-1, Figure 13-2 and Figure 13-3. Figure 13-1 and Figure 13-2 show metal recovery into the lead and zinc concentrates versus grind size and cyanide addition. Figure 13-3 shows metal recovery into the lead rougher flotation concentration versus flotation retention time.

It was found that metal recoveries were generally insensitive to grind size over the range tested with about 98% lead recovery, 96% silver recovery and 92% copper recovery into the lead rougher concentrate. Zinc metallurgy was somewhat impacted at the coarsest grind size of P80 160 µm with 52.5% of the zinc reporting to the zinc concentrate. At the finer grind sizes, zinc recovery into the zinc rougher concentrate ranged from 55% to 60%. As a result of the somewhat improved zinc metallurgy at grind sizes finer than P80 160 µm, a grind size of P80 130 µm was established as the target grind for all future testing. This test series also found that sodium cyanide did not provide any additional depression of the zinc minerals during lead rougher flotation over the range tested. As a result, the use of cyanide was eliminated from any further consideration.

It can be observed from Figure 13-3 that flotation into the lead rougher concentrate is complete after 8 minutes of flotation. It can also be observed that zinc flotation into the lead concentrate can be partially controlled by controlling the rougher flotation retention time due to the slower flotation kinetics associated with the zinc minerals.

Table 13-5: Summary of Grind Size vs. Recovery and Cyanide Addition

Grind P80 µm	160	132	95	71	95	95	95
lb/st NaCN	-	-	-	-	0.01	0.02	0.03
Pb Conc. Recovery %							
Ag	98.0	98.1	98.4	98.3	98.5	98.6	98.5
Pb	96.3	96.1	96.1	95.0	96.4	97.3	97.2
Cu	90.6	91.6	92.4	93.0	92.0	91.6	93.2
Zn	38.6	34.4	36.0	29.5	35.9	38.7	34.4
Zn Conc. Recovery %							
Ag	0.9	0.8	0.8	0.9	0.6	0.6	0.6
Pb	0.5	0.6	0.7	1.3	0.5	0.4	0.4
Cu	1.4	1.3	1.4	1.3	1.3	1.3	1.3
Zn	52.5	55.1	55.5	60.3	55.1	52.2	55.4
Pb Ro Conc. Grade							
Ag (oz/st)	326	318	321	319	290	301	303
Pb (%)	54.5	49.5	49.6	54.0	54.0	56.6	58.4
Cu (%)	3.50	3.40	3.48	3.50	3.38	3.51	3.66
Zn (%)	2.46	2.12	2.20	1.82	2.19	2.42	2.17
Zn Ro Conc. Grade							
Ag (oz/st)	25.3	20.9	14.3	18.2	12.8	14.5	14.7
Pb (%)	2.70	2.40	2.04	4.63	1.91	2.09	1.90
Cu (%)	0.48	0.41	0.30	0.32	0.32	0.41	0.40
Zn (%)	29.1	28.6	19.7	24.2	23.0	26.9	27.5

Source: FLSmidth, 2016.
 Ro = rougher

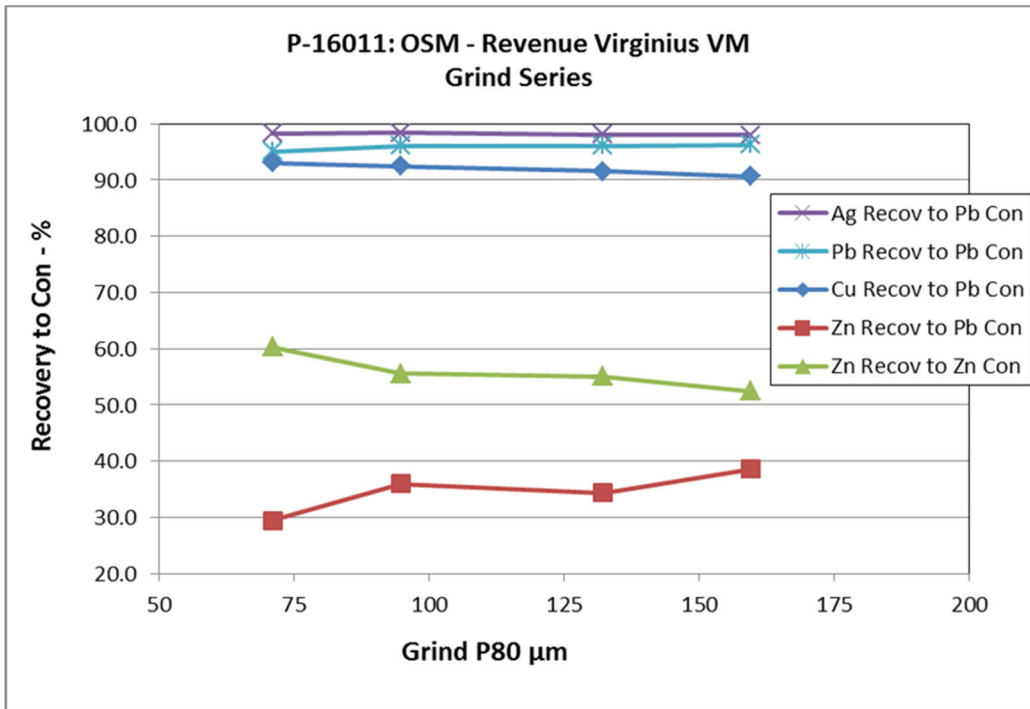

Source: FLSmidth, 2016

Figure 13-1: Metal Recovery into the Lead and Zinc Rougher Concentrates vs. Grind Size

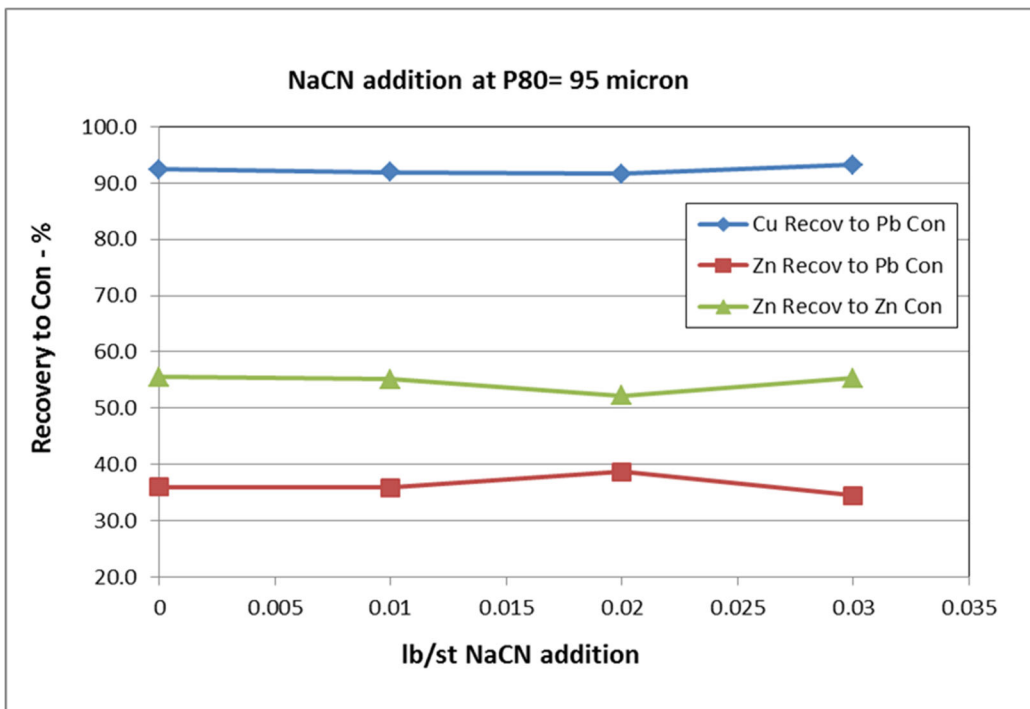

Source: FLSmidth, 2016

Figure 13-2: Metal Recovery to the Lead and Zinc Rougher Concentrates vs. Cyanide Addition

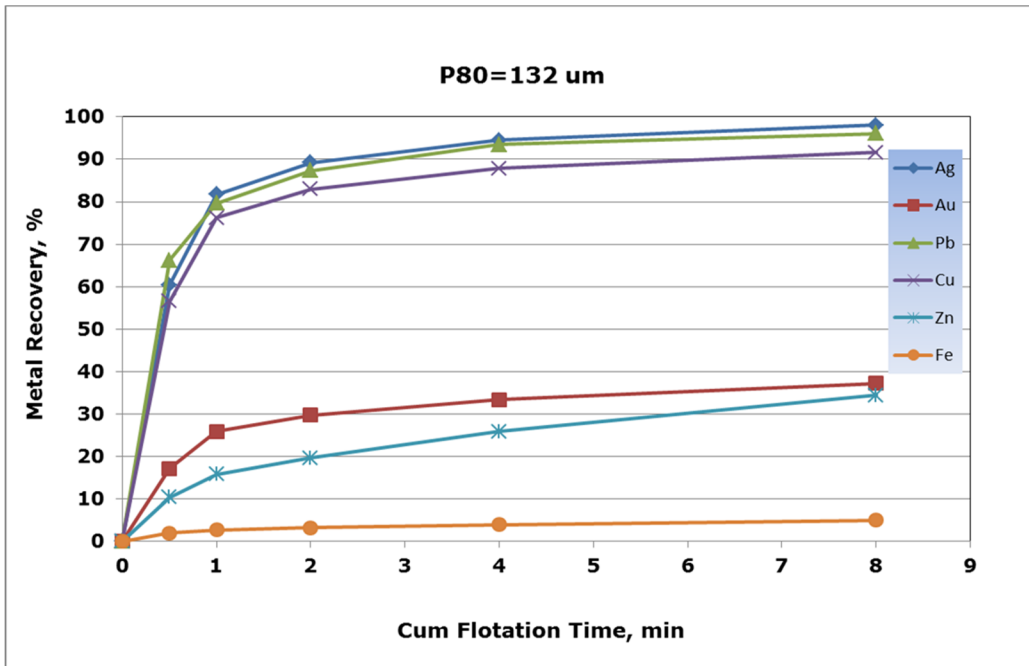

Source: FLSmidth, 2016

Figure 13-3: Metal Recovery into the Lead Rougher Flotation Concentrate vs. Retention Time

Open Circuit Cleaner Flotation

After completion of the reagent scoping and grind-recovery test series, larger scale lead and zinc rougher flotation tests were run under the following optimized conditions in order to generate lead and zinc rougher concentrates for open circuit cleaner flotation studies:

Lead Rougher Flotation

- Primary grind: P80 130 µm
- PH: 7.2 (natural)
- ZnSO4: 0.5 lb/st
- MBS: 0.5 lb/st
- Cytec 3418A: 0.015 lb/st
- Cytec 232: 0.01 lb/st
- Retention Time: 8 minutes

Zinc Rougher Flotation

- PH: 11.9 (with lime)
- CuSO4.5H2O: 0.22 lb/st
- SIPX: 0.03 lb/st
- Retention Time: 3 minutes

The lead rougher concentrates were then reground to various grind sizes ranging from P₈₀ 90 µm (no regrinding) to P₈₀ 32 µm and then upgraded in one stage of cleaner flotation with the following conditions:

- ZnSO4: 0.025 lb/st
- MBS: 0.025 lb/st
- Cytec 3418A: as needed
- PH: 7.5
- Retention Time: 5 minutes

The zinc rougher concentrate was upgraded in one stage of cleaner flotation with the following conditions:

- SIPX: 0.03 lb/st
- PH: 10.5
- Retention Time: 2 minutes

The results of both lead and zinc flotation after one stage of open circuit cleaner flotation are summarized in Table 13-6. Without regrinding, it was possible to achieve an overall recovery of 91.6% of the silver, 45% of gold, 93.4% of lead and 87.3% of copper into a lead cleaner flotation concentrate containing 59.8% Pb, 350 oz/st Ag, 3.8% Cu and 1.8% Zn. Approximately 28% of the zinc contained in the ore reported to the lead cleaner concentrate. Regrinding of the lead concentrate resulted in slower flotation kinetics and slightly lower overall lead recoveries. This is shown graphically in Figure 13-4. Silver, gold and copper in the lead concentrate did not appear to be affected by regrinding.

The results of this test series indicated that regrinding of the lead concentrate prior to cleaner flotation was not required. As such, all future lead cleaner flotation testwork was performed without regrinding. Metal recovery during first stage lead cleaner flotation versus retention time (without regrinding) is shown graphically in Figure 13-5. Metal recovery is essentially complete after 3 to 5 minutes of laboratory-scale flotation.

Table 13-6: Summary of First Stage Lead and Zinc Cleaner Flotation vs. Re grind Size

Lead Cleaner - 1 Conc.										
Regrind	Grade (oz/st or %)					Overall / Recovery (%) ⁽¹⁾				
P80 µm	Ag	Au	Pb	Cu	Zn	Ag	Au	Pb	Cu	Zn
90	350	0.03	59.8	3.76	1.83	91.6	45.2	93.4	87.3	27.7
50	362	0.03	53.7	3.94	1.78	92.3	42.8	88.2	85.1	26.2
35	352	0.03	66.7	4.36	1.97	92.7	44.8	90.6	87.3	26.5
32	340	0.03	62.4	4.31	2.71	90.7	47.4	90.4	89.0	39.0
Zinc Cleaner -1 Conc.										
Regrind	Grade (oz/st or %)					Overall / Recovery (%) ⁽¹⁾				
P80 µm	Ag	Au	Pb	Cu	Zn	Ag	Au	Pb	Cu	Zn
90	65	0.05	6.4	1.1	38.4	1.7	7.3	1.0	2.5	57.5
50	68	0.05	7.9	1.3	35.8	1.7	7.6	1.2	2.7	50.6
35	46	0.04	4.6	0.9	42.4	1.2	6.9	0.6	1.9	58.7
32	55	0.07	10.7	1.0	33.5	1.0	7.4	1.1	1.4	34.0

Source: FLSmidth, 2016

¹Overall recovery based on ore feed

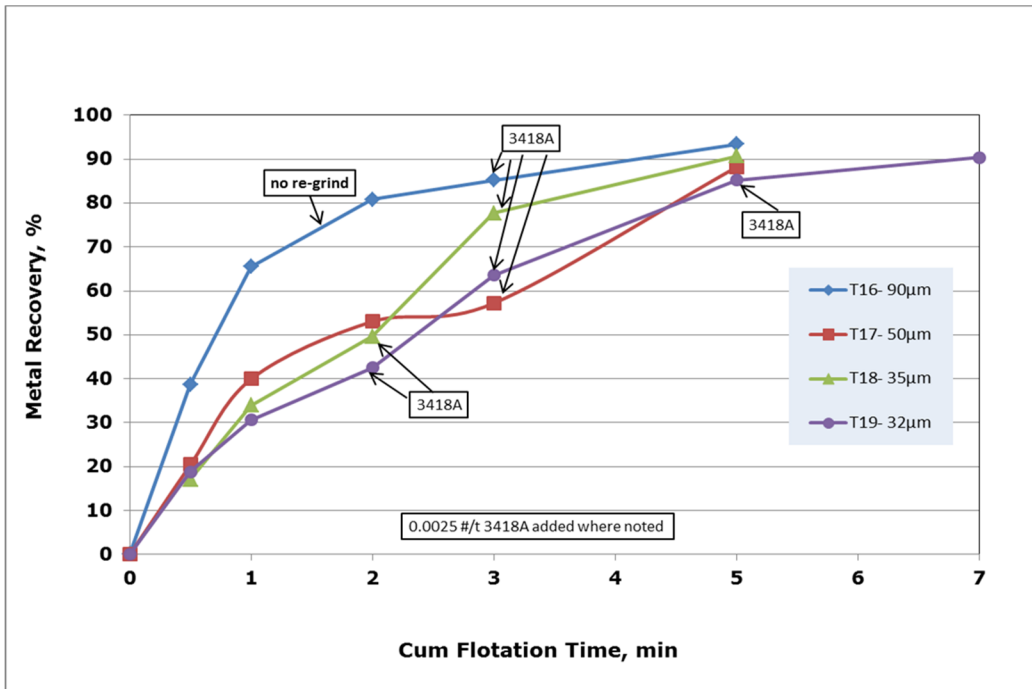

Source: FLSmidth, 2016

Figure 13-4: Lead Recovery into First Stage Cleaner Concentrate vs. Retention Time

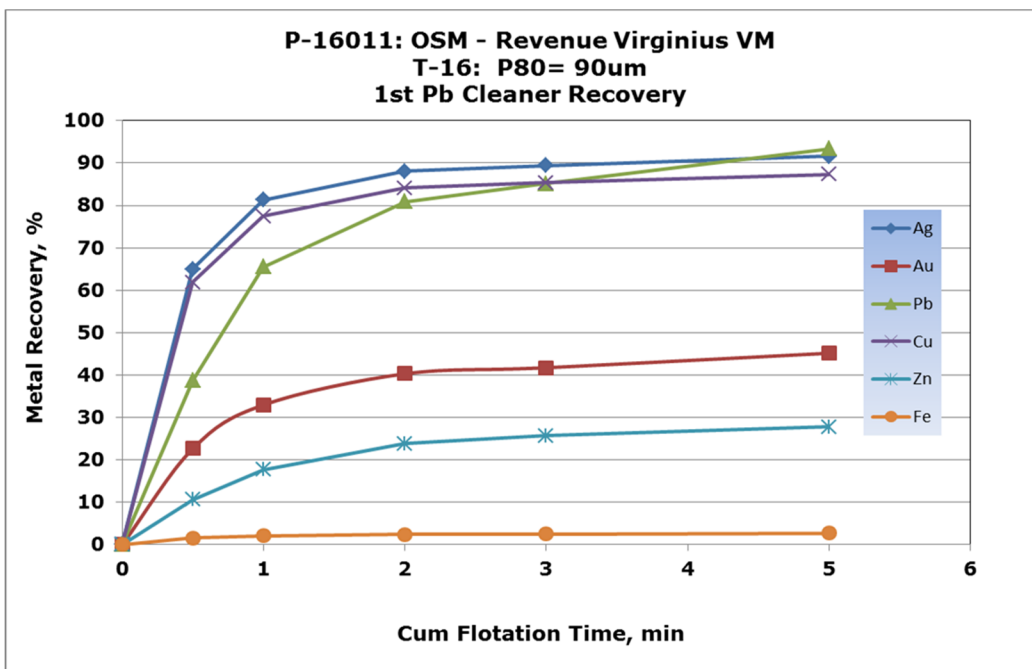

Source: FLSmidth, 2016

Figure 13-5: Metal Recovery during First Stage Lead Cleaner Flotation vs. Retention Time (No Re grind)

Locked-Cycle Test

A seven-stage locked-cycle test was run on the Virginius Main master composite using the optimized flotation parameters to simulate the disposition of intermediate process products in a continuous flotation circuit. The flowsheet used for the locked-cycle test is shown in Figure 13-6 and included the following parameters:

- Primary grinding to P80 130 µm
- Addition of 0.5 lb/st zinc sulfate and 0.5 lb/st MBS during grinding as zinc mineral depressants
- Conditioning with 0.01 lb/st Cytec 3418A and 0.01 lb/st Cytec 242
- Lead rougher flotation for 8 minutes
- Conditioning for zinc flotation with lime to pH 11.9 and 0.22 lb/st copper sulfate
- Conditioning with 0.03 lb/st sodium isopropyl xanthate
- Zinc rougher flotation for 3 minutes
- Lead cleaner-1 flotation with cleaner-1 tailing recycled to lead rougher flotation
- Lead cleaner-2 flotation with cleaner-2 tailing recycled to lead rougher flotation
- Zinc cleaner-1 flotation with cleaner-1 tailing recycled to zinc rougher flotation

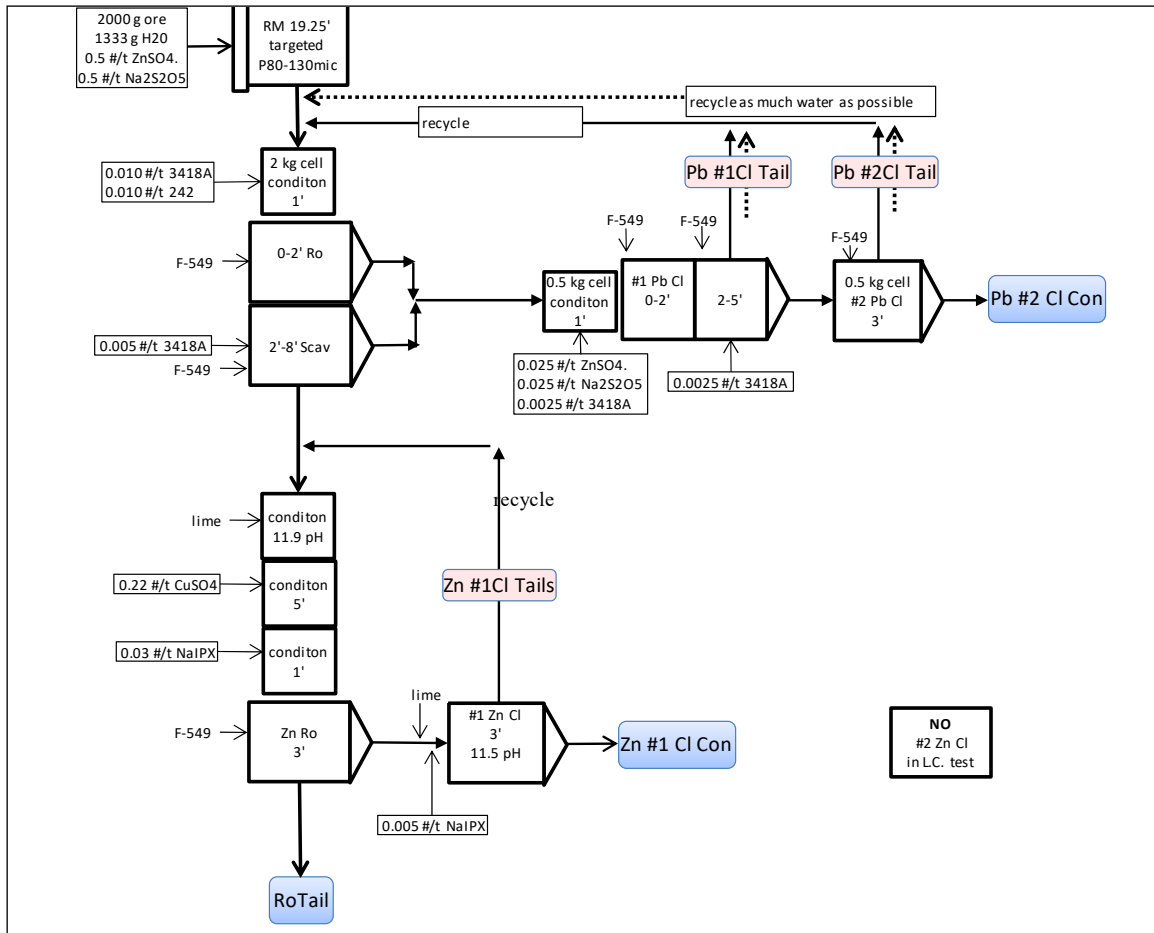

Source: FLSmidth, 2016

Figure 13-6: Locked-Cycle Test Flowsheet

The results for the locked cycle test (average of last three cycles) are summarized in Table 13-7 and show that 96.6% of the silver, 47.5% of the gold, 96.2% of the lead and 90.6% of copper were recovered into a lead cleaner flotation concentrate containing 69.1% Pb, 378 oz/st Ag, 0.03 oz/st Au, 3.6% Cu and 2.2% Zinc. Almost 32% of the zinc in the feed reported to the lead cleaner concentrate. Zinc flotation recovered 56.2% of zinc, 1.3% of the silver and 4.5% of the gold into a zinc cleaner concentrate containing 46.5% Zn, 60.7 oz/st Ag and 0.03 oz/st Au. Overall silver recovery was 97.8% and overall gold recovery was 52%.

Table 13-7: Summary of Locked-Cycle Test on Virginius Main Master Composite (Average of Cycles 5, 6, and 7)

Product	Wt. %	Grade (oz/st)		Grade (%)				Distribution (%)					
		Ag	Au	Pb	Cu	Zn	Fe	Ag	Au	Pb	Cu	Zn	Fe
Lead Cleaner - 2 Conc.	8.22	378	0.030	69.1	3.63	2.19	1.68	96.6	47.5	96.2	90.6	31.8	2.7
Zinc Cleaner -1 Conc.	0.68	60.7	0.034	4.4	0.55	46.5	3.20	1.3	4.5	0.5	1.1	56.2	0.4
Zinc Rougher Tails	91.10	0.8	0.003	0.21	0.030	0.07	5.35	2.2	48.0	3.3	8.3	11.9	96.8
Total Cycle 5, 6, 7	100.00	32.2	0.005	5.91	0.33	0.56	5.03	100.0	100.0	100.0	100.0	100.0	100.0

Source: FLSmidth, 2016

13.2.5 Metallurgical Testwork: Variability Composites

Three variability composites were evaluated during the PFS metallurgical program and tested against the optimized flotation parameters that had been developed for the Virginius Main master composite. The confirmatory testwork conducted on each of the variability composites included initial differential lead and zinc rougher flotation tests in which flotation kinetic data was gathered. This was followed by locked-cycle testing that included differential lead and zinc rougher flotation, two stages of lead cleaner flotation and one stage of zinc cleaner flotation with recirculation of the cleaner flotation tailings. In addition, thickening and filtration testwork was conducted on the rougher flotation tailings generated from each variability composite. The variability composites that were developed for this program are described as follows:

Differential Lead and Zinc Rougher Flotation

Virginius Main High Dilution Variability Composite (VHD)

The results of differential lead and zinc rougher flotation tests on the VHD composite conducted under optimized conditions are summarized in Table 13-8, and show that about 97% of the silver, 43% of the gold, 96% of lead and 93% of copper were recovered into a lead rougher concentrate containing 55% Pb, 295 oz/st Ag, 0.03 oz/st Au and 3.4% Zn. About 59% of the zinc and an additional 1.3% of the gold and 9.6% of the silver were recovered into the zinc rougher concentrate at a grade of 19.9% Zn, 21 oz/st Ag and 0.03 oz/st Au. Rougher flotation metal recoveries as a function of flotation retention time are shown in Figure 13-7. Metal recovery into the lead rougher concentrate was complete after six to eight minutes of flotation. Zinc recovery into the zinc rougher concentrate was complete after 4 minutes of flotation.

Table 13-8: Summary of Rougher Flotation Test on Virginius Main High Dilution Composite

Product	Wt %	Grade					Distribution (%)				
		Ag (oz/st)	Au (oz/st)	Pb (%)	Cu (%)	Zn (%)	Ag	Au	Pb	Cu	Zn
Lead Ro. Conc.	6.7	295	0.03	55.1	3.35	2.08	97.4	43.3	95.9	93.2	32.6
Zinc Ro. Conc.	1.3	21	0.03	4.13	0.34	19.9	1.3	9.6	1.4	1.8	58.6
Zinc Ro Tails	92.0	0.3	0.002	0.11	0.01	0.04	1.3	47.1	2.7	5.0	8.9
Calculated Head	100.0	20.3	0.004	3.85	0.24	0.43	100.0	100.0	100.0	100.0	100.0

Source: FLSmidth, 2016

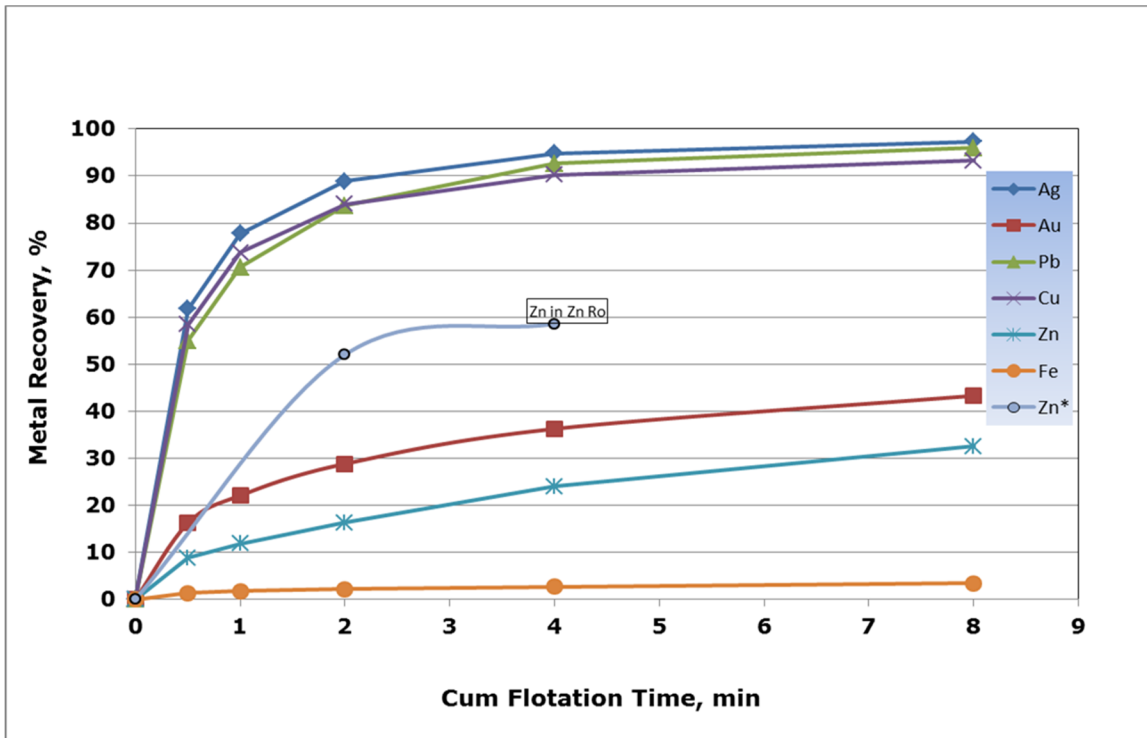

Source: FLSmidth, 2016

Figure 13-7: Rougher Flotation Metal Recoveries vs. Retention Time: Virginius High Dilution Variability Composite

Virginius Hanging Wall Variability Composite (VHW)

The results of differential lead and zinc rougher flotation tests on the VHW composite, conducted under optimized conditions, are summarized in Table 13-9. These results show that about 90% of the silver, 67% of the gold, 91% of the lead and 80% of copper were recovered into a lead rougher concentrate containing 26.7% Pb, 185 oz/st Ag, 0.2 oz/st Au and 6.5% Zn. About 69% of the zinc and an additional 3.5% of the silver and 10.4% of the gold were recovered into the zinc rougher concentrate at a grade of 26.1% Zn, 11 oz/st Ag and 0.05 oz/st Au. Rougher flotation metal recovery as a function of flotation retention time is shown in Figure 13-8. Metal recovery into the lead rougher concentrate was complete after six to eight minutes of flotation. Zinc recovery into the zinc rougher concentrate was complete after four minutes of flotation. The lower silver, lead and copper recoveries during lead rougher flotation are attributed to the lower grades of these metals in the VHW composite. Similarly, the higher zinc recovery into the zinc rougher concentrate is attributed to the higher zinc grade of the composite.

Table 13-9: Summary of Rougher Flotation Tests on the Virginius Hanging Wall Variability Composite

Product	Wt%	Grade					Distribution (%)				
		Ag (oz/st)	Au (oz/st)	Pb (%)	Cu (%)	Zn (%)	Ag	Au	Pb	Cu	Zn
Lead Ro. Conc.	4.7	185	0.20	26.7	2.07	6.52	90.2	66.6	90.9	80.1	26.6
Zinc Ro. Conc.	3.1	11	0.05	1.05	0.17	26.1	3.5	10.4	2.3	4.2	69.1
Zinc Ro Tails	92.2	0.7	0.004	0.10	0.02	0.05	6.3	23.0	6.8	15.7	4.3
Calculated Head	100.0	9.7	0.014	1.39	0.12	1.16	100.0	100.0	100.0	100.0	100.0

Source: FLSmidth, 2016

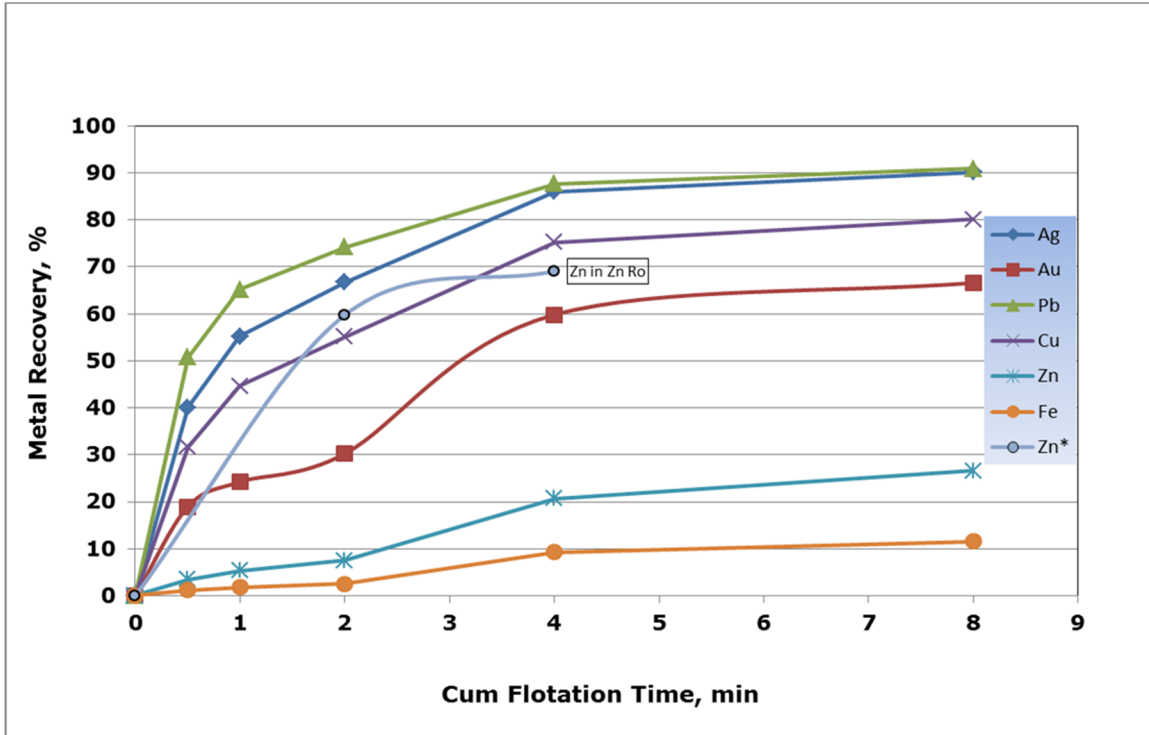

Source: FLSmidth, 2016

Figure 13-8: Rougher Flotation Metal Recoveries vs. Retention Time: Hanging Wall Variability Composite

Virginius Master/Yellow Rose Variability Composite (VMYR)

The results of differential lead and zinc rougher flotation tests on the VMYR composite conducted under optimized conditions are summarized in Table 13-10 and show that about 97% of the silver, 58% of the gold, 95% of lead and 94% of copper were recovered into a lead rougher concentrate containing 51% Pb, 291 oz/st Ag, 0.12 oz/st Au and 4.5% Zn. About 56% of the zinc and an additional 2.0% of the silver and 27.8% of the gold were recovered into the zinc rougher concentrate at a grade of 17.2% Zn, 16 oz/st Ag and 0.16 oz/st Au. Rougher flotation metal recoveries as a function of flotation retention time are shown in Figure 13-9. Metal recovery into the lead rougher concentrate was complete after six to eight minutes of flotation. Zinc recovery into the zinc rougher concentrate was complete after four minutes of flotation.

Table 13-10: Summary of Rougher Flotation Test on the Virginius Master/Yellow Rose Variability Composite

Product	Wt %	Grade					Distribution (%)				
		Ag (oz/st)	Au (oz/st)	Pb (%)	Cu (%)	Zn (%)	Ag	Au	Pb	Cu	Zn
Lead Ro. Conc.	9.1	291	0.12	50.8	2.97	4.53	96.7	58.2	95.3	94.3	40.0
Zinc Ro. Conc.	3.4	16	0.16	2.94	0.21	17.2	2.0	27.8	2.0	2.5	55.7
Zinc Ro Tails	87.5	0.4	0.003	0.15	0.01	0.05	1.3	14.0	2.7	3.2	4.3
Calculated Head	100.0	27.5	0.019	4.87	0.29	1.03	100.0	100.0	100.0	100.0	100.0

Source: FLSmidth, 2016

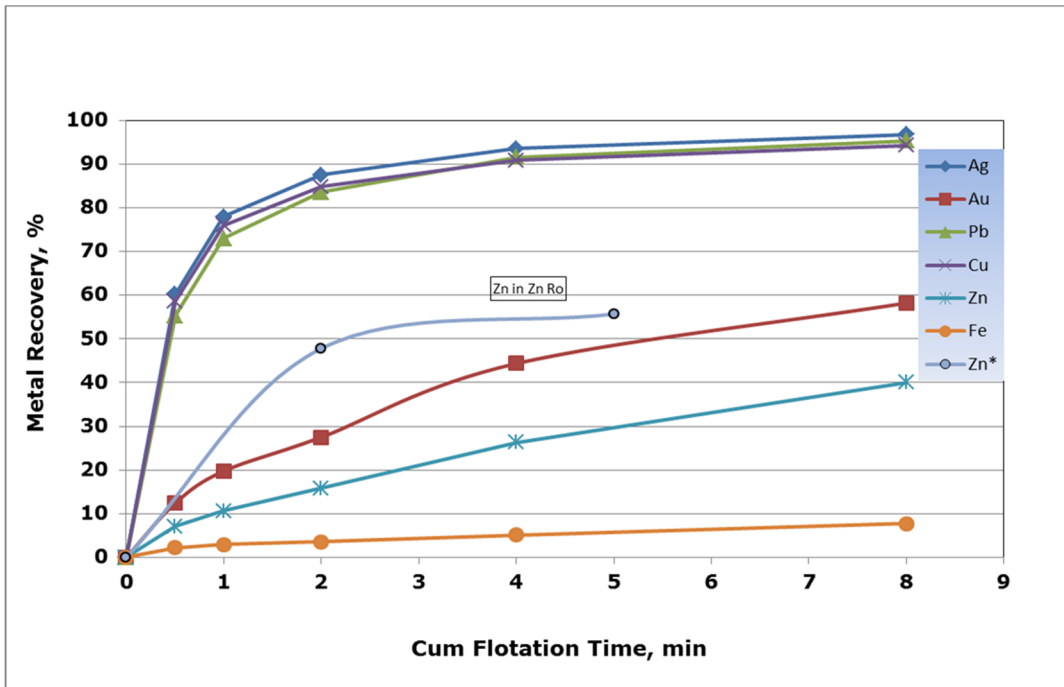

Source: FLSmidth, 2016

Figure 13-9: Rougher Flotation Metal Recoveries vs. Retention Time: Master/Yellow Rose Variability Composite

Locked-Cycle Flotation

Six-stage locked-cycle tests were run on each of the variability composites using the same optimized test flowsheet and parameters that were used for the locked-cycle test on the Virginius Main master composite.

Virginius Main High Dilution Variability Composite (VHD)

The results for the locked cycle test on the VHD composite (average of last three cycles) are summarized in Table 13-11 and show that 97.1% of the silver, 49.7% of the gold, 97.2% of the lead and 95.2% of copper were recovered into a lead cleaner flotation concentrate containing 73.5% Pb, 364 oz/st Ag, 0.047 oz/st Au, 4.5% Cu and 2.8% Zinc. About 38% of the zinc in the feed reported to the lead cleaner concentrate. Zinc flotation recovered 52.7% of zinc, 0.6% of the silver and 4.7% of the gold into a zinc cleaner concentrate containing 41.7% Zn, 22 oz/st Ag and 0.05 oz/st Au. Overall silver recovery was 97.7% and overall gold recovery was 54.4% and 0.05 oz/st Au. Overall silver recovery was 97.7% and overall gold recovery was 54.5%.

Table 13-11: Summary of Locked Cycle Test on the Virginius High Dilution Variability Composite (Average of Cycles 4, 5 & 6)

Product	Wt.%	Grade (oz/st)		Grade (%)				Distribution (%)					
		Ag	Au	Pb	Cu	Zn	Fe	Ag	Au	Pb	Cu	Zn	Fe
Lead Cleaner-2 Conc.	5.6	364	0.047	73.5	4.52	2.81	1.92	97.1	49.7	97.2	95.2	38.3	1.9
Zinc Cleaner-1 Conc.	0.5	22	0.048	3.83	0.32	41.7	5.06	0.6	4.7	0.5	0.6	52.7	0.5
Zinc Rougher Tails	93.9	0.5	0.003	0.11	0.012	0.039	5.94	2.3	45.5	2.5	4.4	9.2	97.8
Total - Cycle 4, 5, 6	100.0	21.0	0.005	4.03	0.25	0.40	5.70	100.0	100.0	100.0	100.0	100.0	100.0

Source: FLSmidth, 2016

Virginius Hanging Wall Variability Composite (VHW)

The results for the locked cycle test on the VHW composite (average of last three cycles) are summarized in Table 13-12 and show that 87.8% of the silver, 70.3% of the gold, 91.7% of the lead and 83% of copper were recovered into a lead cleaner flotation concentrate containing 40.3% Pb, 267 oz/st Ag, 0.34 oz/st Au, 3.2% Cu and 9.9% Zinc. About 32% of the zinc in the feed reported to the lead cleaner concentrate. Zinc flotation recovered 57.5% of zinc, 1.4% of the silver and 2.8% of the gold into a zinc cleaner concentrate containing 48.9% Zn, 12 oz/st Ag and 0.04 oz/st Au. Overall silver recovery was 89.3% and overall gold recovery was 73.1%. The lower silver, lead and copper recoveries, as well as the lower grade of the lead cleaner concentrate are most likely attributable to the lower grade of the VHW composite, which contained 10.7 oz/st Ag, 1.55% Pb and 0.14% Cu.

Table 13-12: Summary of Locked-Cycle Test on the Virginius Hanging Wall Composite (Average of Cycles 4, 5 and 6)

Product	Wt. %	Grade (oz/st)		Grade (%)				Distribution (%)					
		Ag	Au	Pb	Cu	Zn	Fe	Ag	Au	Pb	Cu	Zn	Fe
Lead Cleaner-2 Conc.	3.5	267	0.340	40.3	3.24	9.89	13.99	87.8	70.3	91.7	83.0	32.0	10.5
Zinc Cleaner-1 Conc.	1.3	12	0.037	0.73	0.19	48.9	3.97	1.4	2.8	0.6	1.7	57.5	1.1
Zinc Rougher Tails	95.2	1.2	0.005	0.13	0.022	0.12	4.37	10.7	26.9	7.7	15.2	10.5	88.4
Total - Cycle 4, 5, 6	100	10.7	0.017	1.55	0.14	1.09	4.70	100.0	100.0	100.0	100.0	100.0	100.0

Source: FLSmidth, 2016

Virginius Master/Yellow Rose Variability Composite (VMYR)

The results for the locked cycle test on the VMYR composite (average of last three cycles) are summarized in Table 13-13 and show that 96.7% of the silver, 61.8% of the gold, 95.9% of the lead and 93.5% of copper were recovered into a lead cleaner flotation concentrate containing 64.6% Pb, 353 oz/st Ag, 0.1 oz/st Au, 3.8% Cu and 5.0% Zinc. About 40% of the zinc in the feed reported to the lead cleaner concentrate. Zinc flotation recovered 52.5% of zinc, 1.3% of the silver and 5.9% of the gold into a zinc cleaner concentrate containing 31.7% Zn, 22 oz/st Ag and 0.05 oz/st Au. Overall silver recovery was 98% and overall gold recovery was 67.7%.

Table 13-13: Summary of Locked-Cycle Test on the Virginius Main/Yellow Rose Blend Variability Composite

Product	Wt. %	Grade (oz/st)		Grade (%)				Distribution (%)					
		Ag	Au	Pb	Cu	Zn	Fe	Ag	Au	Pb	Cu	Zn	Fe
Lead Cleaner-2 Conc.	7.6	353	0.099	64.6	3.85	5.01	3.12	96.7	61.8	95.9	93.5	40.0	5.1
Zinc Cleaner-1 Conc.	1.6	22	0.046	3.74	0.34	31.7	12.1	1.3	5.9	1.1	1.7	52.5	4.1
Zinc Rougher Tails	90.8	0.6	0.004	0.16	0.016	0.079	4.62	2.1	32.2	2.9	4.8	7.5	90.8
Total - Cycle 4, 5, 6	100.0	27.7	0.012	5.07	0.31	0.97	4.62	100.0	100.0	100.0	100.0	100.0	100.0

Source: FLSmidth, 2016

13.2.6 Thickening and Filtration Studies

Thickening and pressure filtration tests were conducted on the zinc rougher flotation tailings and final lead cleaner concentrate produced from the Virginius Main master composite. In addition, thickening and pressure filtration tests were conducted on the zinc rougher flotation tailings produced from each of the three variability composites. The results of this work are documented in two FLSmidth's reports, "Thickening, Rheology and Pressure Filtration Testing: Virginius Master No. 2 Lead Cleaner

Concentrate and Zinc Scavenger Tailings”, June 2016 and “Thickening and Pressure Filtration Testing - Zinc Scavenger Tailings: Variability Samples”, June 2016.

Thickening Studies

The results of the thickening tests on the zinc scavenger tailings and the lead cleaner concentrate are summarized in Table 13-14. An anionic polyacrylamide flocculant with a high molecular weight and medium charge density produced the best overall clarity and settling velocities (Hychem AF 309, or equivalent) and flocculant dosages for the zinc scavenger tailing ranged from about 20 to 25 g/mt for the master composite to 35 to 45 g/mt for the Master composite/Yellow Rose blend variability composite. The specific unit settling area for the zinc scavenger tailings ranged from 0.05 m²/mt/d for the Master composite to 0.12 m²/mt/d for the Master/Yellow Rose blend variability composite. The recommended flocculant dosage for the lead cleaner concentrate is about 10 g/mt of concentrate and the specific settling area for the lead cleaner concentrate was reported at 0.1 m²/mt/d.

These specific settling areas indicate that both the zinc scavenger tailings and lead cleaner concentrate can be expected to settle very well, but it should be recognized for thickener sizing purposes that specification of settling areas less than 0.125 m²/mt/d is impractical due to rise rate limitations. As such, actual thickener specifications and scale-up factors should be provided by selected thickener vendors prior to finalizing equipment selection.

The recommended underflow slurry density from the concentrate thickener is approximately 80% solids, which results in a yield stress of about 25 Pa. with a retention time of less than one hour. The recommended slurry density for the tailings thickener underflow is approximately 60% to 65% solids for the Virginus composites and about 50% to 55% solids for the Virginus Main/Yellow Rose Blend composite. Underflow yield stress for the scavenger tailings ranged from 20 to 50 Pa.

Table 13-14: Thickener Sizing Parameters (Metric): Zinc Scavenger Flotation Tailing and Lead Cleaner Concentrate

Thickening Parameters	Units	Zinc Scavenger Flotation Tailings				Lead Cl Conc.
		Master	Variability Composites			Master
		VM	VHD	VHW	VMYR	VM
Thickener Type		high rate	high rate	high rate	high rate	conventional
Feedwell Slurry Density	wt%	10	10	10	10	30
Flocculant dosage	g/mt	20 to 25	15 to 20	20 to 30	35 to 45	10
Unit Area	m ² /mt/d	0.045	0.05	0.07	0.12	0.1
Solids Loading	mt/d/m ²	22				10
Recommended Max. Rise Rate	m/h	10				1 -1.25
Design Underflow Slurry Density	wt%	65	60	60	54	80
Overflow Clarity	ppm	<100	<100	<100	<100	<200
U/F Yield Stress at Design	Pa	50	20	35	25	25

Source: FLSmidth, 2016

Filtration Studies

FLSmidth tested pressure filtration methods for both the lead concentrate and flotation tailing samples at the feed solids concentrations determined for the thickener testwork. This testwork generated design data used for sizing their PneumaPress filter for the concentrate and a recessed chamber plate and frame filter press for the flotation tailings. FLSmidth also provided data to correlate the PneumaPress test results to develop sizing specifications for a concentrate filter press. The results of the PneumaPress filtration testwork on the lead cleaner concentrate are summarized in Table 13-15. The results of the pressure filtration testwork conducted on the zinc flotation tailing samples and FLSmidth’s

estimated parameters for lead concentrate filtration with a recessed pressure filter are presented in Table 13-16.

Test results on the lead cleaner concentrate indicate that the PneumaPress can achieve filtration rates of approximately 3,000 to 6,000 kg/m²/h at cake moistures of less than 4%. FLSmidth's correlation of the PneumaPress results to a conventional plate and frame filter press, indicate an estimated filter press specific filtration area of 792 to 1,273, kg/m²/h would be required to filter the lead cleaner concentrate.

Recessed chamber filter press testwork on the zinc scavenger tailing samples from the Virginius Master, Virginius High Dilution (VHD) and Virginius Hanging Wall (VHW) composites demonstrated that with a 50 mm chamber and an applied pressure of 15.5 bar that specific filtration rates of 150 to 175 kg/m²/h will yield a cake moisture of about 14% to 15 wt%. The Virginius Master/Yellow Rose Blend composite yielded filter cakes with higher moisture contents ranging from 16.7 to 19.3 wt%.

It should be noted that filtration testwork on the zinc cleaner flotation concentrate was not conducted because suitable quantities of zinc concentrate could not be generated for this purpose.

Table 13-15: Lead Concentrate PneumaPress® Filtration Test Result

No. 2 Lead Cleaner Conc. (VM)	
Cake/Chamber Thickness (mm)	55
Cake Formation / Drying Pressure (bar)	10
Cake Formation Time (min)	0.12
Cake Drying Time (min)	0.55 to 2.8
Technical Time (min)	1.5
Total Cycle Time (min)	2.2 to 2.8
Cake Moisture (wt %)	2.7 to 4.4
Filtration Rate (kg/m ² /h)	3,000 to 6,000

Source: FLSmidth, 2016

Table 13-16: Pressure Filtration Sizing Parameters - Zinc Scavenger Flotation Tailing and Lead Cleaner Concentrate

Filtration Parameters	Units	Zinc Scavenger Flotation Tailings				Lead CI Conc.
		Master	Variability Composites			Master
		VM	VHD	VHW	VMYR	VM
Filter Type Thickener Type		pressure	pressure	pressure	pressure	pressure
Cake Thickness	mm	50	50	50	50	50
Formation Pressure	bar	15.5	15.5	15.5	15.5	10
Formation time	minutes	7.5	4	5.5	3	0.25
Cake Drying Time	minutes	0 to 8	0 to 7	0 - 8	0 - 5	0 - 3
Technical Time	minutes	4.5	4.5	4.5	4.5	4.5
Cake Moisture	wt %	14.2 to 15.5	15.1 to 17.7	15.1 to 17.0	16.7 to 19.3	2.7 to 11
Filtration Rate	kg/m ² /h	150 to 250	175 to 325	154 to 277	215 to 360	792 to 1273

Source: FLSmidth, 2016

13.3 Feasibility Metallurgical Studies

Feasibility-level metallurgical studies were conducted by FLSmidth (Dawson), and the results of these studies are fully documented in their report "Report of Feasibility Level Flotation on Variability Composite Samples From OSMI's Revenue Mine" May 4, 2017. This program was based on the outcomes of the PFS metallurgical program and resulted in further optimization of the flotation process to recover the contained metal values in separate lead and zinc cleaner flotation concentrates. This

program was conducted on variability composites that represented spatial and grade variations within the Virginus Main Vein, the Footwall Vein and the Yellow Rose Vein, as well as a master composite the was formulated to represent the weighted average contribution from these veins during the first five years of mining.

13.3.1 Test Sample Characterization

Five variability samples were collected for the feasibility-level metallurgical program. These samples were identified as follows:

- VM-1 (VM-Mong): Virginus Main Vein sample from the Monongahela area
- VM-2 (VM-Divide): Virginus Main Vein sample from the decline area
- VF-1 (FW-Stope): Virginus Footwall Vein sample from the 231 stope
- VF-2 (FW-Divide): Virginus Footwall Vein sample from the decline area
- YR-1 (Yellow Rose): Yellow Rose Vein sample

The VM-1, VM-2, VF-1 and VF-2 samples were collected by drilling and blasting and then collecting five to six sub-samples that were each placed in five-gallon buckets and assayed separately prior to compositing. The YR-1 samples were collected by scaling fractured material and collecting the material into five 5-gallon buckets which were also assayed separately prior to compositing. The following protocol was used for each of the sampling points:

- Multiple sub-samples of vein material and dilution material were collected in each sampling area
- Each sub-sample was assigned a specific identification number
- Identification of each sampling location with accurate three-dimensional coordinates
- Photograph of each sub-sample
- Photograph of each sampling location with a description of the geology

Table 13-17 provides a description and coordinates for each of the variability samples and Figure 13-10 shows the actual locations from which each of the samples was taken.

Table 13-17: Metallurgical Sample Description and Locations

Sample	Type	Location	Coordinates			Weight (kg)	Description
			East (ft)	North (ft)	Elev. (ft)		
VM-1	Main Vein	561 stope	93,544	96,565	10,752	136	Quartz-carbonate vein with galena, sphalerite, tetrahedrite and pyrite
VM-1	Dilution (andesite)	561 stope	93,544	96,565	10,752	NA	Vein transects andesite dyke
VF-1	Footwall Vein	231 stope	94,055	95,924	10,709	163	Quartz-carbonate vein with galena, sphalerite, tetrahedrite and pyrite
VF-1	Dilution (pyroclastic)	231 stope	94,055	95,924	10,709	53	Vein transects andesitic-dacitic pyroclastic flows
VM-2	Main Vein	Decline 19L	94,818	94,846	10,691	132	Quartz-carbonate vein with galena, sphalerite, tetrahedrite and pyrite
VM-2	Dilution (andesite)	Decline 19L	94,818	94,846	10,691	NA	Vein transects andesite dyke
VF-2	Footwall Vein	Decline 65L	94,996	94,492	10,644	145	Quartz-carbonate vein with galena, sphalerite, tetrahedrite and pyrite

Sample	Type	Location	Coordinates			Weight (kg)	Description
			East (ft)	North (ft)	Elev. (ft)		
VF-2	Dilution (pyroclastic)	Decline 65L	94,996	94,492	10,644	53	Vein transects andesitic-dacitic pyroclastic flows
YR-1	Yellow Rose Vein	Yellow Rose	101,780	97,432	11,130	171	Quartz-carbonate vein with galena, sphalerite, tetrahedrite and pyrite
YR-1	Dilution (pyroclastic)	Yellow Rose	101,780	97,432	11,130	55	Vein transects andesitic-dacitic pyroclastic flows

Source: OSMI, 2017

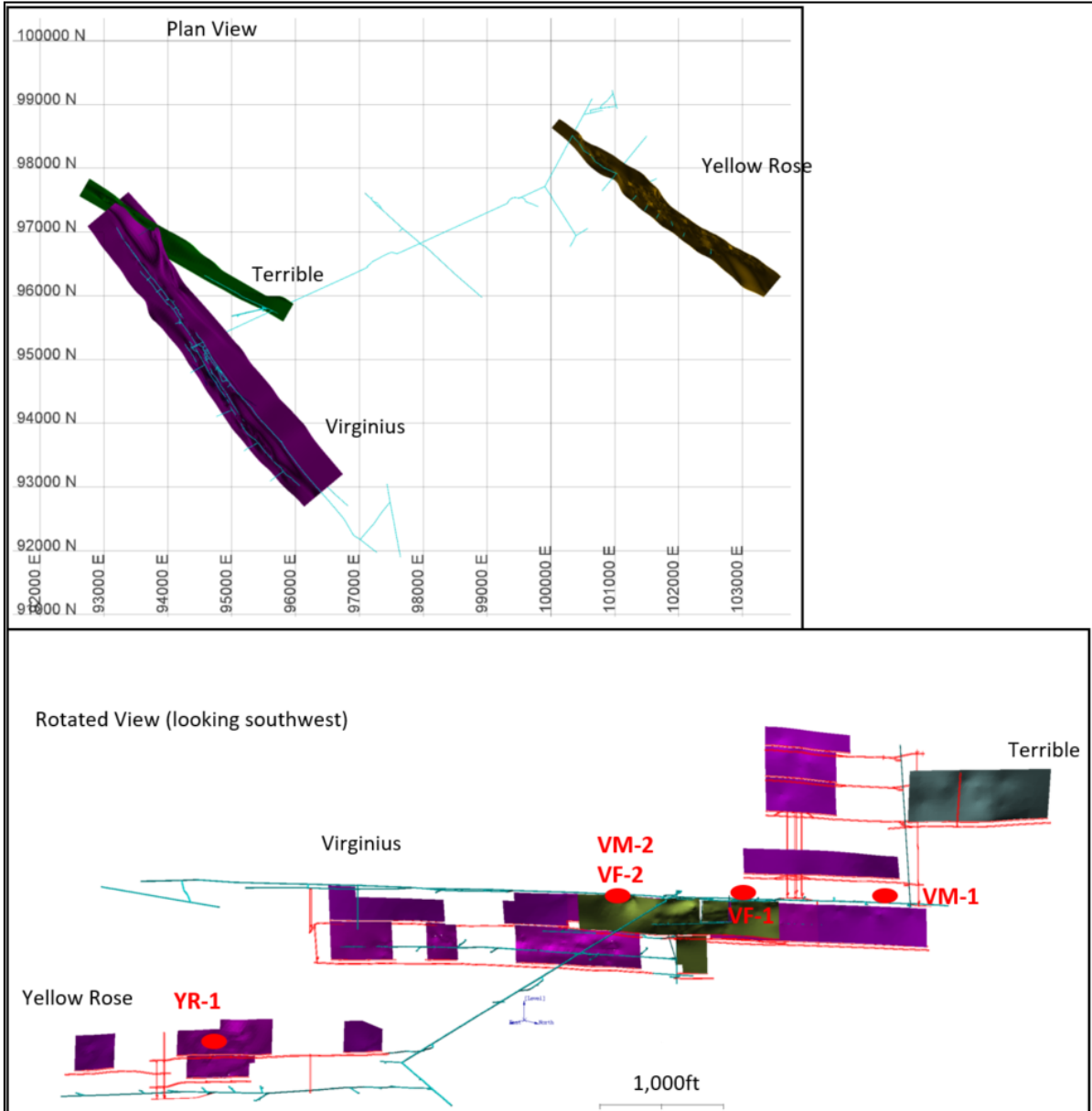

Source: OSMI, 2017

Figure 13-10: Feasibility Study Metallurgical Sample Locations

The buckets of vein and dilution material from each area of the mine were assayed individually and on the basis of these assays, the percentage of dilution with unmineralized material was determined in order to achieve composite target grades that would correspond with ore grades that were similar to those established in the mine plan. Table 13-18 shows the predicted average undiluted and diluted grades for each variability composite. Table 13-19 shows the actual head assays for each variability composite. Also shown are the calculated and assay heads for the master composite that was formulated on the basis of the mine plan contribution from each area:

- Virginius Main Vein: 69.8%
- Virginius Footwall Vein: 9.4%
- Yellow Rose Vein: 20.8%

Table 13-18: Variability Composite Predicted Ore Grades with Dilution

Sample	Type	Dilution (%)	Ag (oz/st)	Pb (%)	Cu (%)	Zn (%)
VM-1	Vein		27	6.2	0.3	2.4
VM-1	Dilution		<0.1	0.019	0.01	0.03
Diluted		0%	27.0	6.2	0.3	2.4
VM-2	Vein		54.2	9.7	0.73	0.92
VM-2	Dilution		0.4	0.12	0.01	0.06
Diluted		70%	38.9	7	0.5	0.7
VF-1	Vein		66	15.9	0.8	2.0
VF-1	Dilution		<0.1	0.024	0.022	0.01
Diluted		80%	36.7	8.0	0.4	1.0
VF-2	Vein		18.7	5.0	0.2	5.3
VF-2	Dilution		<0.1	0.011	0.015	0.02
Diluted		50%	12.5	3.3	0.1	3.5
YR-1	Vein		57.7	13.1	0.4	5.1
YR-1	Dilution		<0.1	0.049	0.003	0.016
Diluted		80%	32.1	7.3	0.2	2.8

Source: FLSmidth/SRK, 2017

Table 13-19: Head Assays for Feasibility Study Master Composite and Variability Composites

Sample	Master Comp. %	Ag (oz/st)	Au (oz/st)	Pb (%)	Cu (%)	Zn (%)	Fe (%)	S(t) (%)	S (=) (%)
VM-1	34.9	28	0.016	6.67	0.28	2.88	2.77	4.25	3.96
VM-2	34.9	39	0.170	10.40	0.51	0.67	4.51	3.73	3.54
VF-1	4.7	36	0.010	9.69	0.46	1.21	3.21	2.90	2.84
VF-2	4.7	12	0.068	3.40	0.15	3.86	4.73	4.98	4.88
YR-1	20.8	31	0.011	7.09	0.20	2.92	2.94	4.78	4.35
Master Comp.	Calc. Head	32.2	0.071	8.05	0.35	2.08	3.52	4.15	3.88
Master Comp.	Assay Head	31.6	0.079	7.53	0.26	1.97	3.59	4.29	3.97

Source: FLSmidth, 2017

13.3.2 Mineralogical Analyses

A representative sub-sample of the Master composite that had been ground to the target grind of P80 130 µm was examined by XRD and AMA for mineralogy, locking/liberation analyses and trace mineral detection. The results of this work are presented in FLSmidth’s report, “Mineralogical Characterization of Master Composite from Ouray Revenue Mine and Flotation Concentrates”, April 18, 2017. The minerals detected and their concentrations in each size fraction are shown in Table 13-20. Lead was found to occur as galena, zinc was found to occur as sphalerite and copper was found to occur

primarily as chalcopyrite and tetrahedrite. Tetrahedrite and polybasite were identified as the primary silver-bearing minerals in the Master composite with tetrahedrite accounting for about 75% of the silver and polybasite accounting for about 25% of the silver.

The liberation of galena, chalcopyrite, sphalerite and tetrahedrite for the Master Composite are presented in Table 13-21. Galena and sphalerite are approximately 90% liberated. Chalcopyrite and tetrahedrite show higher amounts of middlings (20% to 30%). Chalcopyrite middlings are associated with tetrahedrite, sphalerite, pyrite, arsenopyrite and gangue. Sphalerite middlings are associated with galena, pyrite, and gangue.

Table 13-20: Mineral Occurrence in the Master Composite

Mineral	Combined Wt %	Size Fraction (µm)			
		+106	-106/+53	-53/+20	-20
		33.7	28.43	16.03	21.84
Chalcopyrite	0.56	0.39	0.47	0.71	0.84
Tetrahedrite	0.67	0.51	0.67	0.99	0.67
Other (Cu)	0.03	0.04	0.03	0.02	0.02
Galena	9.32	2.96	12.1	15.0	11.4
Sphalerite	3.11	2.46	3.66	3.89	2.84
Pyrite	2.93	2.31	3.41	3.63	2.74
Arsenopyrite	0.46	0.26	0.58	0.47	0.60
Polybasite	0.04	0.02	0.03	0.07	0.07
Quartz	46.3	54.6	48.6	42.1	33.4
K Feldspar	9.20	11.08	8.29	8.43	8.04
Plagioclase	4.60	3.87	3.08	3.41	8.58
Muscovite	7.90	8.00	6.95	7.57	9.22
Chlorite	3.72	3.71	2.82	3.44	5.10
Smectite/Kaolinite	0.71	0.62	0.50	0.55	1.27
Amphibole/Pyroxene	0.02	0.03	0.01	0.01	0.01
Calcite/Carbonates	4.03	3.85	3.45	3.93	5.13
Rhodochrosite	2.69	2.60	2.25	2.55	3.52
Siderite	0.57	0.27	0.26	0.33	1.62
Iron Oxide	0.94	0.99	0.85	0.80	1.07
Rutile/Ilmenite	0.18	0.16	0.14	0.19	0.24
Apatite	0.14	0.11	0.07	0.09	0.32
Epidote	0.03	0.03	0.03	0.03	0.02
Rhodonite	0.18	0.25	0.17	0.14	0.10
Barite	1.29	0.62	1.25	1.34	2.35
Other	0.44	0.32	0.34	0.36	0.81

Source: FLSmidth, 2017

Table 13-21: Sulfide Mineral Liberation in the Master Composite

Mineral	Distribution (%)			
	Galena	Chalcopyrite	Tetrahedrite	Sphalerite
Liberated Galena	91.6	0.08	0.63	0.01
Liberated Chalcopyrite	0.01	64.2	0.11	0.02
Liberated Tetrahedrite	0.00	0.25	61.8	0.01
Liberated Sphalerite	0.06	0.36	0.57	89.4
Liberated Pyrite	0.17	0.13	0.04	0.04
Middling Galena	5.55	2.14	2.61	0.87
Middling Chalcopyrite	0.05	22.7	2.27	0.72
Middling Tetrahedrite	0.06	1.14	29.3	0.45
Middling Sphalerite	0.18	0.46	1.00	6.42
Locked Galena	2.08	0.48	0.07	0.13
Locked Chalcopyrite	0.07	7.50	0.08	0.02

Mineral	Distribution (%)			
	Galena	Chalcopyrite	Tetrahedrite	Sphalerite
Locked Tetrahedrite	0.00	0.09	0.98	0.00
Locked Sphalerite	0.14	0.24	0.31	1.82
Complex	0.03	0.21	0.19	0.05
Barren	0.00	0.00	0.00	0.00
Other	0.00	0.00	0.00	0.00

Source: FLSmidth 2017

13.3.3 Comminution

RWi and BWi determinations were made on each of the variability composites and the master composites. The RWi determinations were conducted with a closing screen of 1,180 µm and resulted in RWi determinations that ranged from 11.7 to 14.0 kWh/st for the variability composites and 12.9 kWh/st for the master composite. The BWi determinations were conducted with a 180 µm closing screen and ranged from 13.7 to 16.2 kWh/st for the variability composites and 15.6 kWh/st for the master composite. The results of these tests are summarized in Table 13-22. It is noted that these determinations are slightly lower than what was reported for the test composites used in the PFS.

Table 13-22: Bond Ball Mill and Rod Mill Work Indices on Variability and Master Composites

Composite	BWi		RWi	
	KWh/st	KWh/mt	KWh/st	KWh/mt
VM-1	13.7	15.1	11.7	12.9
VM-2	15.7	17.3	14.0	15.4
VF-1	16.0	17.6	14.0	15.5
VF-2	16.2	17.9	13.2	14.5
YR-1	14.7	16.2	13.2	14.5
Master	15.6	17.2	12.9	14.2

Source: FLSmidth, 2017

13.3.4 Confirmatory Flotation Studies

Confirmatory tests were performed on the variability composites to demonstrate the optimized flotation procedure developed during the earlier PFS. The procedure consisted of grinding the ore with zinc sulfate and sodium metabisulfite (zinc mineral depressants) to a grind size of P80 130 µm. The ground slurry was then conditioned with the collectors Aerophine 3418 and Aerofloat 242 and then floated to produce a lead-silver-copper rougher flotation concentrate, which was then upgraded with two stages of cleaner flotation without regrinding. The lead rougher flotation tailing was then adjusted to pH 11.9 (with lime) and conditioned with copper sulfate (zinc mineral activator) and xanthate collector and then subjected to flotation to produce a separate zinc rougher concentrate, which was upgraded with two stages of cleaner flotation without regrinding.

The results of the confirmatory flotation tests are summarized in Table 13-23 and demonstrated flotation performance similar to what had been achieved during the earlier prefeasibility studies. As an example, the confirmatory test on the master composite recovered 92.7% of the lead, 94% of the silver and 72% of the gold into a lead cleaner flotation concentrate containing 74% lead, 292 oz/st silver and 0.47 oz/st gold. Zinc flotation recovered 75.5% of the zinc, 1.5% of the silver and 4.7% of the gold in a zinc cleaner flotation concentrate containing 54% Zn, 16 oz/st Ag and 0.10 oz/st Au.

Table 13-23: Summary of Confirmatory Lead and Zinc Flotation Test Results

Test #	Sample	Pb #2 CI Con										Zn #2 CI Con									
		Wt (%)	Ag oz/s	Au oz/st	Pb (%)	Cu (%)	% Distribution					Wt %	Ag (oz/st)	Au (oz/st)	Pb (%)	Zn (%)	% Distribution				
							Ag	Au	Pb	Cu	Zn						Ag	Au	Pb	Zn	
1	VM-Mong	9.0	300	0.07	69	3.2	98	23	94.5	82	17	3.4	9	0.04	0.5	63	1.1	5.0	0.2	75.6	
7	VM-	14.0	268	0.78	72	3.5	96	74	94.0	90	29	1.2	25	0.40	6.1	33	0.8	3.6	0.7	58.5	
8	FW-Stope	11.3	298	0.03	75	3.9	93	24	92.7	90	29	1.1	35	0.08	2.9	52	1.1	7.6	0.4	52.4	
4	FW-	5.6	182	0.44	60	2.1	83	35	94.6	68	8	5.6	11	0.18	0.5	62	4.9	14.3	0.8	85.8	
5	Yellow	8.5	321	0.12	78	2.4	87	66	89.8	86	14	4.0	30	0.03	2.8	60	3.8	3.6	1.5	78.2	
6	Maser	10.3	292	0.47	74	3.0	94	72	92.7	85	18	3.0	16	0.10	2.1	54	1.5	4.7	0.8	75.5	

Source: FLSmidth, 2017

13.3.5 Large Batch Flotation Studies

Large scale flotation tests (16 kg ore charge) were performed on the Master composite and each variability composite in order to obtain a sufficient amount of rougher tailings material for subsequent tailings thickening and filtration and also to generate a sufficient amount of lead and zinc rougher flotation concentrates for meaningful cleaner flotation tests. Test procedures were similar to those established during the confirmatory testwork. Lead rougher flotation time was maintained at 12 minutes for most of the samples. Lead cleaner-1 flotation was 6 minutes and lead cleaner-2 flotation was 8 minutes. The standard zinc rougher float retention time was 6 minutes, and zinc cleaner-1 and cleaner-2 flotation time was maintained at 3 minutes. The results of the large batch flotation tests are summarized in Table 13-24, and were generally similar to the confirmatory test results. The large batch test on the master composite recovered 91.0% of the lead, 95% of the silver and 72% of the gold into a lead cleaner flotation concentrate containing 71% lead, 296 oz/st silver and 0.46 oz/st gold. Zinc flotation recovered 74.3% of the zinc, 1.4% of the silver and 3.0% of the gold into a zinc cleaner flotation concentrate containing 55% Zn, 16 oz/st Ag and 0.07 oz/st Au.

Table 13-24: Summary of Large Batch Lead and Zinc Flotation Test Results

Test Number	Sample	Pb #2 CI Conc.										Zn #2 CI Conc.									
		% Wt	oz/st Ag	oz/st Au	% Pb	% Cu	% Distribution					% Wt	oz/st Ag	oz/st Au	% Pb	% Zn	% Distribution				
							Ag	Au	Pb	Cu	Zn						Ag	Au	Pb	ZN	
9	VM-Mong	9.4	291	0.10	65	2.9	97	37	94.6	76	21	3.7	9	0.10	1.8	54	1.2	14.7	1.0	73.8	
10	VM-Divine	13.8	275	0.70	70	3.4	94	78	94.0	80	22	1.5	29	0.48	9.8	34	1.1	5.5	1.4	67.7	
11	FW-Stope	11.0	312	0.05	71	3.7	91	48	90.8	86	18	1.4	39	0.04	3.4	62	1.4	5.1	0.6	70.7	
12	FW-Divine	5.3	184	0.46	58	2.0	78	39	93.6	72	6	5.1	11	0.06	0.5	65	4.6	5.2	0.8	87.0	
13	Yellow Rose	11.1	289	0.11	62	1.9	90	72	91.8	91	22	3.4	17	0.02	1.0	64	1.6	3.4	0.4	67.1	
14	Master Comp	10.2	296	0.46	71	3.3	95	72	91.0	90	18	2.8	16	0.07	3.4	55	1.4	3.0	1.2	74.3	

Source: FLSmidth, 2017

Figure 13-11 presents the lead cleaner-2 flotation metal recoveries versus retention time for the master composite and each of the variability composites. Generally, a laboratory-scale cleaner-2 flotation retention time of 4 minutes was found to be sufficient. Figure 13-12 presents the zinc cleaner-2 flotation metal recoveries versus retention time. Generally, a laboratory-scale cleaner-2 flotation time of 2 to 3 minutes was sufficient. It should be noted that laboratory-scale flotation retention times are scaled up by a factor of 2.5 to 3.0 for plant design.

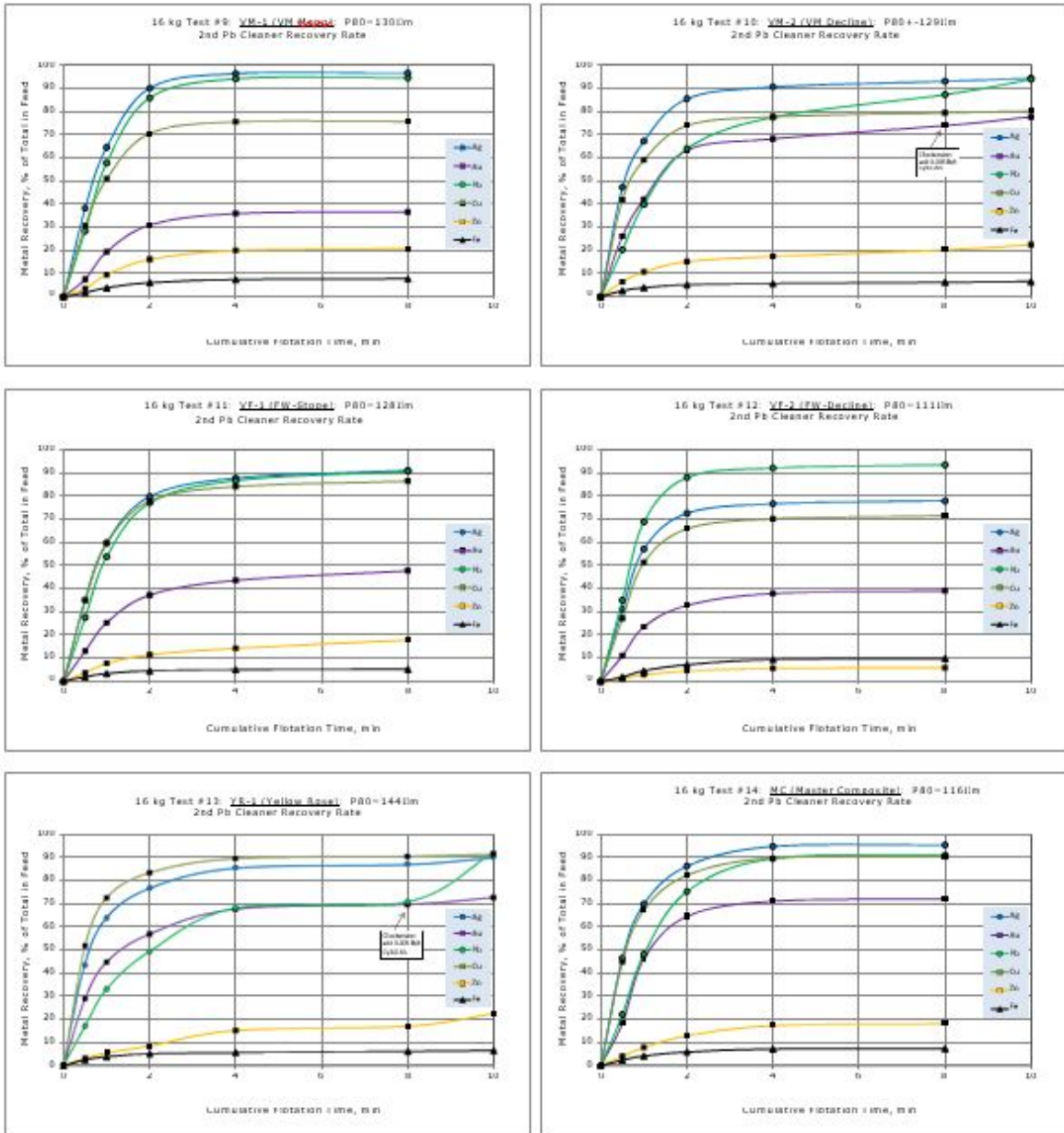

Source: FLSmidth, 2017

Figure 13-11: Lead Cleaner-2 Flotation vs. Retention Time

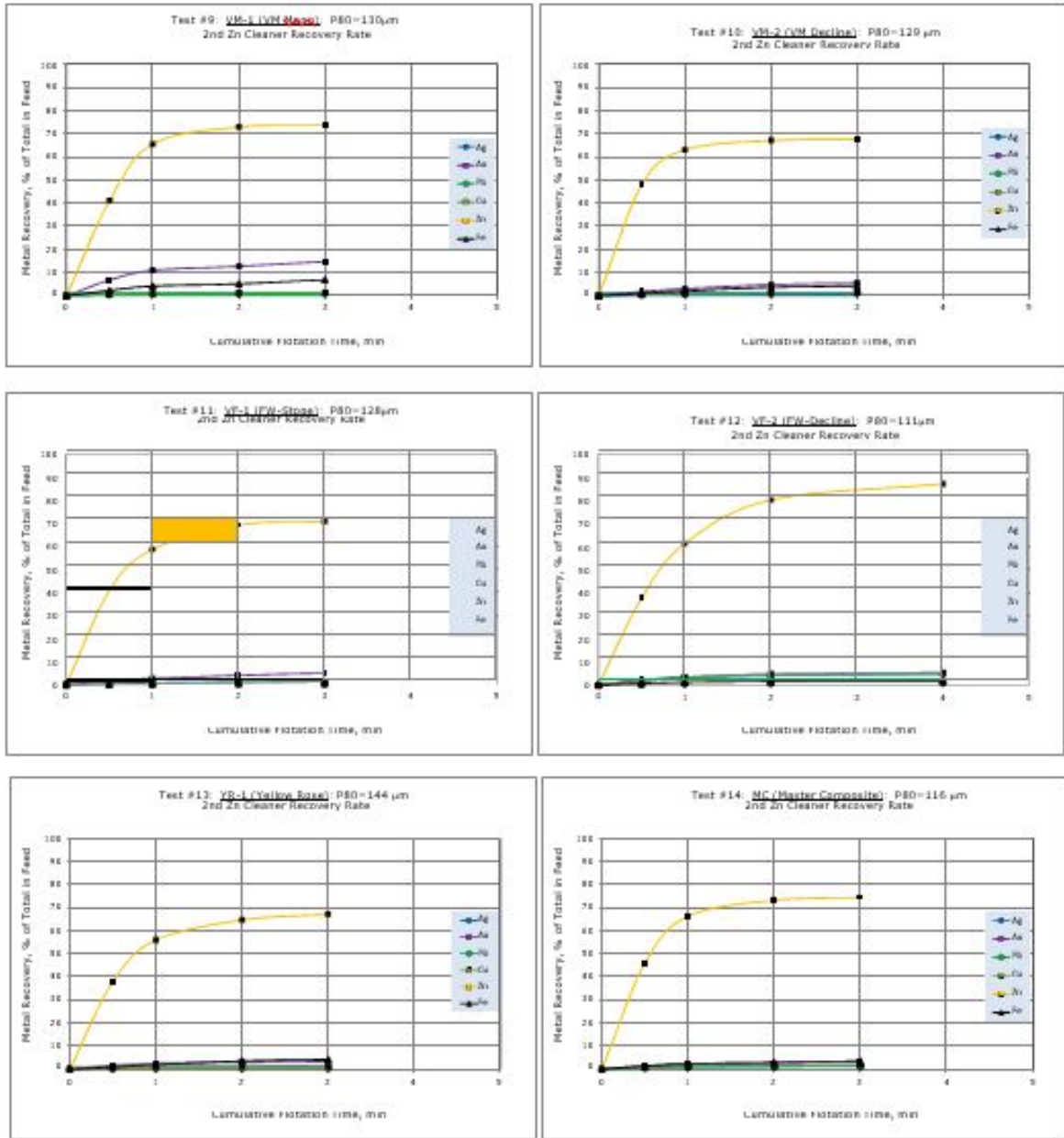

Source: FLSmidth, 2017

Figure 13-12: Zinc Cleaner-2 Flotation vs. Retention Time

13.3.6 Locked-Cycle Test on Master Composite

One six-stage locked-cycle test was performed on the master composite in order to assess the impact of recirculating intermediate flow streams (lead and zinc cleaner flotation tailings) on overall metal recoveries and concentrate grades. The locked-cycle test was conducted using optimized test conditions and the same flowsheet that was used for the PFS metallurgical program. The test flowsheet included lead rougher flotation followed by zinc rougher flotation. The lead rougher flotation concentrate was upgraded with two stages of cleaner flotation and the cleaner flotation tailings were recycled back to the conditioner ahead of lead rougher flotation. The zinc rougher flotation concentrate

was also upgraded with two stages of cleaner flotation, with the zinc cleaner flotation tailings recycled to the conditioner ahead of zinc rougher flotation. Optimized Locked-cycle test conditions included:

- Primary grinding to P80 130 µm
- Addition of 0.5 lb/st zinc sulfate and 0.5 lb/st MBS during grinding as zinc mineral depressants
- Conditioning with 0.01 lb/st Cytec 3418A and 0.01 lb/st Cytec 242
- Lead rougher/scavenger flotation for 8 minutes
- Conditioning for zinc flotation with lime to pH 11.9 and 0.25 lb/st copper sulfate
- Conditioning with 0.03 lb/st sodium isopropyl xanthate
- Zinc rougher flotation for 3 minutes
- Stage addition of F-549 frother as needed
- No concentrate regrind
- Rougher concentrate conditioning with zinc sulfate, sodium metabisulfite and 3418A prior to cleaner flotation
- Lead cleaner-1 flotation for 5 minutes with cleaner-1 tailing recycled to lead rougher flotation
- Lead cleaner-2 flotation for 3 minutes with cleaner-2 tailing recycled to lead rougher flotation
- Zinc cleaner-1 flotation for 3 minutes with cleaner-1 tailing recycled to zinc rougher flotation
- Zinc cleaner-2 flotation for 2 minutes with cleaner-2 tailing recycled to zinc rougher flotation

The average results of the last three cycles of the locked-cycle test are summarized in Table 13-25 and shows that 94.7% of the lead, 94.8% of the silver, 91.4% of the copper and 74.2% of the gold were recovered into a lead cleaner concentrate that contained 70.3% Pb, 286 oz/st Ag, 3.07% Cu and 0.41 oz/st Au. Zinc flotation resulted in the recovery of 72.9% of the zinc, 1.3% of the silver and 2.0% of the gold into a zinc cleaner concentrate that contained 57.5% Zn, 16 oz/st Ag and 0.048 oz/st Au.

Table 13-25: Summary of Locked-Cycle Test Results on the Master Composite (Average of Last 3 Cycles)

Locked Cycle Test on Master Composite											
Balance for - Cycle 4, 5, 6	Weight (g)	Weight (%)	Assay - oz/st		Assay - %					Assay - ppm	
			Ag	Au	Pb	Cu	Zn	Fe	S=	As	Sb
Pb #2 Cl Con	641.7	10.70	286	0.41	70.3	3.07	4.18	2.52	NA	1,968	15,215
Zn #2 Cl Con	154.0	2.57	16	0.048	2.30	0.18	57.5	3.86	NA	5,197	627
Rougher Tails	5,200.5	86.73	1.5	0.016	0.42	0.030	0.12	4.10	1.49	NA	NA
Total - Cycle 4, 5, 6	5,996.2	100.00	32.3	0.060	7.95	0.36	2.02	3.92	NA	NA	NA
Distribution - %											
Pb #2 Cl Con	-	10.70	94.8	74.2	94.7	91.4	22.1	6.9	-	-	-
Zn #2 Cl Con	-	2.57	1.3	2.0	0.7	1.3	72.9	2.5	-	-	-
Rougher Tails	-	86.73	3.9	23.8	4.6	7.3	5.0	90.6	-	-	-
Total - Cycle 5, 6, 7	-	100.00	100.0	100.0	100.0	100.0	100.0	100.0	-	-	-

Source: FLSmidth, 2017

13.3.7 Thickening and Filtration Studies

Thickening Studies

The large-scale flotation tests (using 16 kg ore) were performed on the master composite in order to obtain a sufficient amount of flotation rougher tailings for thickening and filtration testwork. Results of this work are fully documented in FLSmidth’s report, “Ouray Silver Mine – Revenue Mine Project – Thickening and Filtration Testing” April 19, 2017. The results of the thickening tests on the zinc scavenger tailings and the lead cleaner concentrate are summarized in Table 13-26 and compared to

the thickening test results that were obtained during the earlier PFS metallurgical program. Also shown are the thickener test results for the lead cleaner concentrate produced from the PFS master composite.

Table 13-26: Summary of Thickening Test Results on Feasibility and Prefeasibility Master Composite Flotation Tailing and Lead Concentrate

Parameter	Units	Zinc Scavenger Tailings		Lead Cleaner Conc.
		Feasibility Master Comp.	Prefeasibility Master Comp.	Prefeasibility Master Comp.
Thickener Type		high rate	high rate	Conventional
Recommended Feed Solids Conc.	wt%	10 to 12	10	30
Design Underflow Slurry density	wt%	60	65	80
Minimum Solids Residence Time	hours	0.5		
Recommended Yield Stress	Pa	<30	<50	<25
Overflow clarity	ppm	<200	<100	<200
Recommended Flocculant		anionic-high mol. wt.	anionic-high mol. wt.	anionic-high mol. wt.
Recommended Flocculant Dosage	g/mt	20 to 25	20 to 25	10
Minimum Recommended Unit Area	m ² /mt/d	0.04	0.045	0.1
Maximum Recommended Rise Rate	m/h	16	10	1 to 1.25

Source: FLSmidth, 2016 and 2017

An anionic polyacrylamide flocculant with a high molecular weight and medium charge density produced the best overall clarity and settling velocities and flocculant dosages for the zinc scavenger tailing ranged from about 20 to 25 g/mt for both master composites. The specific unit settling area was similar for the flotation tailings produced from both master composites, ranging from 0.04 to 0.05 m²/mt/d. The recommended flocculant dosage for the lead cleaner concentrate is about 10 g/mt of concentrate and the specific settling area for the lead cleaner concentrate was reported at 0.1 m²/mt/d.

These specific settling areas indicate that both the zinc scavenger tailings and lead cleaner concentrate can be expected to settle very well, but it should be recognized for thickener sizing purposes that specification of settling areas less than 0.125 m²/mt/d is impractical due to rise rate limitations. As such, actual thickener specifications and scale-up factors should be provided by selected thickener vendors prior to finalizing equipment selection.

The recommended underflow slurry density from the concentrate thickener is approximately 80% solids, which results in a yield stress of about 25-Pa. with a retention time of less than one hour. The recommended slurry density for the tailings thickener underflow is approximately 60% to 65% solids.

Filtration Studies

Bench-scale pressure filtration tests were conducted on the rougher flotation tailing produced from the master composite. A feed solids content of 60% solids was used based on preliminary rheology testing. Filter chambers of 50 mm (2.0 inch) and 32 mm (1¼ inch) were used. Results are summarized in Table 13-27 and indicate that a tailing moisture content of 13-21% would be obtained depending on the feed rate. A feed pressure of 9.7 bar (140 Pound-force per square inch (psi)) and a drying pressure of 6.9 bar (100 psi) are recommended. Filter press full-scale filtration rates will vary depending on the mechanical and pumping time, the filter’s size and model, configuration of the filter press as well as

the desired cake moisture. In general, the 50 mm cake condition resulted in higher filtration rates at comparable cake moisture contents to the 32 mm cake, but the 32 mm cake resulted in the lowest ultimate cake moisture.

Table 13-27: Summary of Pressure Filtration Tests on Master Composite Flotation Tailings

Filter Press Results and Recommended Sizing		
Chamber Type	Recessed	
Chamber Thickness, mm	50	32
Feed Solids Concentration, wt%	60	60
Filter Media	18-oz. Felt	18-oz. Felt
Feed Pressure, bar	9.7	9.7
Cake Consolidation Time, min	1.5	0.8
Drying Pressure, bar	6.9	6.9
Cake Moisture, wt%	15-20	13-21
Filtration Rate, kg/m ² /h	160 to 427	105 to 303
Dry Cake Density, kg/ft ³	1,710	1,683

Source: FLSmidth, 2017

13.3.8 Concentrate and Tailing Characterization

Multi-Element Analyses

Multi-element analyses were conducted on the final lead concentrate, zinc concentrate, and flotation tailings produced from Locked-cycle tests on the master composite and the results are presented in Table 13-28. Significant quantities of arsenic and antimony were found in the lead concentrate. The zinc concentrate contained significant levels of arsenic and cadmium.

Table 13-28: Multi-Element Analyses on Lead and Zinc Concentrates and Final Flotation Tailing

Element	Unit	Pb Cl Conc.	Zn Cl Conc.	Ro Tails
(FA) Ag	oz/st	286	16	1.5
Al	wt%	0.10	0.08	4.13
Ba	wt%	< 0.02	< 0.02	0.597
Bi	wt%	<0.001	<0.001	<0.001
Ca	wt%	0.08	0.07	2.03
Cu	wt%	3.11	0.26	0.037
Fe	wt%	2.52	3.52	4.19
K	wt%	0.07	0.16	1.89
Mg	wt%	0.03	0.02	0.62
Mn	wt%	0.39	0.15	1.22
Mo	wt%	< 0.002	< 0.002	< 0.002
Na	wt%	0.07	0.08	0.48
Ni	wt%	<0.003	<0.003	0.004
P	wt%	0.025	0.024	0.075
Pb	wt%	70.3	2.28	0.42
S	wt%	16.0	34.3	1.81
S=	wt%			1.49
Si	wt%	5.49	5.76	19.9
Sn	wt%	< 0.005	< 0.005	< 0.005
Ti	wt%	<0.0065	<0.0065	0.25
W	wt%	0.024	0.354	0.007
Zn	wt%	4.18	57.5	0.116
Zr	wt%	<0.003	<0.003	<0.003
As	ppm	2055	5150	1610
Cd	ppm	299	2870	<3.0
Co	ppm	28	46	27
Cr	ppm	<3.0	<3.0	97

Element	Unit	Pb Cl Conc.	Zn Cl Conc.	Ro Tails
Li	ppm	237	337	307
Re	ppm	56	93	70.5
Sb	ppm	15550	369	72
Sr	ppm	15	<10.0	318
Te	ppm	<10	<10	<10
Tl	ppm	<10	<10	<10
V	ppm	<25.0	<25.0	87
Cl	ppm	<50	<50	
F	ppm	<20	<20	
Hg	ppm	4	31	
Se	ppm	5	19	

Source: FLSmidth, 2017

Optical Mineralogy on Lead and Zinc Concentrates

The lead and zinc concentrates produced from the locked-cycle test on the master composite were examined by optical mineralogy and the following main observations were made:

- Galena, sphalerite, tetrahedrite and chalcopyrite are the main minerals in the lead cleaner concentrate. Pyrite and gangue minerals were observed in minor and trace concentrations.
- Sphalerite is the main mineral detected in the zinc cleaner concentrate and pyrite was observed to be the main diluent followed by galena and lower amounts of gangue and copper-bearing sulfide minerals.
- Galena is predominantly liberated in the lead concentrate. Sphalerite, while present as middlings with chalcopyrite and galena, is also well liberated. Chalcopyrite has many middlings with sphalerite, gangue and tetrahedrite. Most of the gangue minerals observed contained some locked chalcopyrite or galena.
- Sphalerite is mostly liberated in the zinc concentrate. Pyrite is approximately 50% liberated with the other 50% contained in binary or ternary particles with galena and sphalerite. The low amounts of chalcopyrite are usually locked with larger sphalerite grains.

Acid-Base Accounting on the Flotation Tailings

A weighted tailings composite sample from the last 3 cycles was submitted for acid-base accounting (ABA) determination by McClelland Labs in Reno, Nevada and the results are summarized in Table 13-29. It was found that the flotation tailings had an acid generating potential (AGP) of 38.1 and an acid neutralizing potential (ANP) of 89.4, resulting in a net neutralizing potential (NNP) of 51.3 and an ANP/AGP ratio of 2.35. These results indicate that the flotation tailings should not be acid generating.

Table 13-29: Acid-Base Accounting Results on Master Composite Flotation Tailings

Modified Acid/Base Accounting (Mod ABA) Static ARD Potential Test Results, Ouray Mining - Master Composite Locked Cycle Float T#15: Rougher Tailings												
Paste pH	Sulfur, wt.% (as S)					AGP ⁽¹⁾	ANP	NNP	Ratio	Sulfur, wt.% (as S) - HCl Wash		
	Total	SO4	Pyritic S⁼	Non-Ext S	Non Sulfate S					SO4	Pyritic S⁼	Non Sulfate S
8.2	1.74	0.52	1.22	<0.01	1.22	38.1	89.4	51.3	2.35	0.65	1.09	1.09

Source: FLSmidth, 2017

¹AGP based on Pyritic S= content (%S= x 31.25). AGP, ANP and NNP in units of tons CaCO3 equivalents per 1,000 st of solids.

13.4 Recoverability and Relevant Test Results

Metal recoveries into the lead and zinc flotation concentrates from relevant large-batch and locked-cycle tests conducted under optimized test conditions during the PFS and FS metallurgical programs are shown in Table 13-30 and corresponding concentrate grades are shown in Table 13-31. It is SRK's opinion that lead flotation concentrates containing about 65% Pb and zinc flotation concentrates containing about 54% Zn are achievable in actual plant practice. As such, the recoveries shown correspond to a target lead flotation concentrate grades of about 65% Pb and a target zinc concentrate grade of about 54% Zn and represent the recovery into the selected flotation test concentrate product (cleaner-2 concentrate, cleaner-1 concentrate or rougher concentrate) that most closely corresponds to the target lead or zinc flotation concentrate grade.

A linear regression of metal recovery versus ore grade was performed for lead, silver, gold, copper and zinc recoveries into the lead flotation concentrate and zinc recoveries into the zinc flotation concentrate. The results of these linear regressions are shown in Figure 13-13 through Figure 13-18. Metal recoveries were estimated for the grade ranges shown in Table 13-32 by calculating the average metal recovery in each grade range using the regression equations determined for each metal. The following general observations can be made:

- Silver recovery is similar to the PFS with recoveries into the lead concentrate ranging from 93% to 95% depending on feed grade
- Gold recovery into the lead concentrate ranges from 58% to 68% with an additional 4-6% recovery into the zinc concentrate depending upon feed grade
- Lead recovery into the lead concentrate is very consistent at 94% to 95% and relatively independent of feed grade
- Copper recovery into the lead concentrate ranges from 84% to 91% depending upon feed grade
- Zinc recovery into the zinc concentrate is estimated at 60% to 86% depending upon feed grade

Table 13-30: Summary of Relevant Test Results From Feasibility and Prefeasibility Metallurgical Programs

Composite	Study	Test Type	Calculated Head Grade					Pb Conc. Distribution (%)					Zn Conc. Distribution (%)				
			Ag (oz/st)	Au (oz/st)	Pb (%)	Cu (%)	Zn (%)	Ag	Au	Pb	Cu	Zn	Ag	Au	Pb	Cu	Zn
VM-Mong	Feasibility	Large Batch	28	0.025	6.43	0.36	2.75	96.6	36.5	94.6	75.8	20.8	1.2	14.7	1.0	1.3	73.8
VM-Decline	Feasibility	Large Batch	40	0.125	10.3	0.59	0.73	95.1	80.0	94.9	89.8	24.6	1.1	5.5	1.4	1.3	67.7
FW-Stope	Feasibility	Large Batch	38	0.011	8.57	0.47	1.19	93.6	52.8	91.9	88.9	22.4	1.8	6.5	0.9	2.4	71.5
FW-Decline	Feasibility	Large Batch	12	0.063	3.31	0.15	3.79	78.0	39.1	93.6	71.5	5.8	6.1	10.3	1.4	8.0	90.7
Yellow Rose	Feasibility	Large Batch	36	0.017	7.58	0.23	3.26	89.9	72.4	91.8	91.2	22.5	2.6	5.1	1.0	1.5	69.8
Master Comp	Feasibility	Large Batch	32	0.065	7.97	0.37	2.08	96.4	73.0	94.2	91.0	21.1	1.4	3.0	1.2	1.8	74.3
Master Comp	Feasibility	Locked Cycle	32	0.060	7.95	0.36	2.02	94.8	74.2	94.7	91.4	22.1	1.3	2.0	0.7	1.3	74.2
Master Comp	Prefeasibility	Locked Cycle	32	0.005	5.90	0.33	0.56	96.6	47.5	96.2	90.6	31.8	1.3	4.5	0.5	1.1	56.2
VHD	Prefeasibility	Locked Cycle	21	0.005	4.03	0.25	0.40	97.1	49.7	97.2	95.2	38.3	0.6	4.7	0.5	0.6	52.7
VHW	Prefeasibility	Locked Cycle	11	0.017	1.55	0.14	1.09	87.8	70.3	91.7	83.0	32.0	1.4	2.8	0.6	1.7	57.5
VMYR	Prefeasibility	Locked Cycle	28	0.012	5.07	0.31	0.97	96.7	61.8	95.9	93.5	40.0	1.3	5.9	1.1	1.7	52.5

Source: FLSmidth, 2016 and 2017

Table 13-31: Summary of Concentrate Grades from Relevant Test Results from Feasibility and Prefeasibility Metallurgical Programs

Composite	Study	Test Type	Calculated Head Grade					Pb Conc. Grade					Zn Conc. Grade				
			Ag (oz/st)	Au (oz/st)	Pb (%)	Cu (%)	Zn (%)	Ag (oz/st)	Au (oz/st)	Pb (%)	Cu (%)	Zn (%)	Ag (oz/st)	Au (oz/st)	Pb (%)	Cu (%)	Zn (%)
VM-Mong	Feasibility	Large Batch	28	0.025	6.43	0.36	2.75	291	0.098	65.1	2.88	6.10	9	0.099	1.75	0.12	54.2
VM-Decline	Feasibility	Large Batch	40	0.125	10.3	0.59	0.73	261	0.683	66.8	3.26	1.22	29	0.476	9.48	0.52	33.8
FW-Stope	Feasibility	Large Batch	38	0.011	8.57	0.47	1.19	289	0.046	64.8	3.43	2.20	47	0.047	5.27	0.77	57.5
FW-Decline	Feasibility	Large Batch	12	0.063	3.31	0.15	3.79	184	0.464	58.5	2.02	4.14	13	0.107	0.76	0.20	56.5
Yellow Rose	Feasibility	Large Batch	36	0.017	7.58	0.23	3.26	289	0.112	62.5	1.92	6.58	21	0.021	1.71	0.08	53.3
Master Comp	Feasibility	Large Batch	32	0.065	7.97	0.37	2.08	271	0.426	67.0	3.03	3.92	16	0.071	3.37	0.24	55.0
Master Comp	Feasibility	Locked Cycle	32	0.060	7.95	0.36	2.02	286	0.410	70.3	3.07	4.18	16	0.048	2.30	0.18	57.5
Master Comp	Prefeasibility	Locked Cycle	32	0.005	5.90	0.33	0.56	378	0.030	69.1	3.63	2.19	61	0.034	4.40	0.55	46.5
VHD	Prefeasibility	Locked Cycle	21	0.005	4.03	0.25	0.40	364	0.047	73.5	4.52	2.81	22	0.048	3.83	0.32	41.7
VHW	Prefeasibility	Locked Cycle	11	0.017	1.55	0.14	1.09	267	0.340	40.3	3.24	9.84	12	0.037	0.73	0.19	45.0
VMYR	Prefeasibility	Locked Cycle	28	0.012	5.07	0.31	0.97	353	0.099	64.6	3.85	3.85	22	0.046	3.74	0.34	31.7

Source: FLSmidth, 2016 and 2017

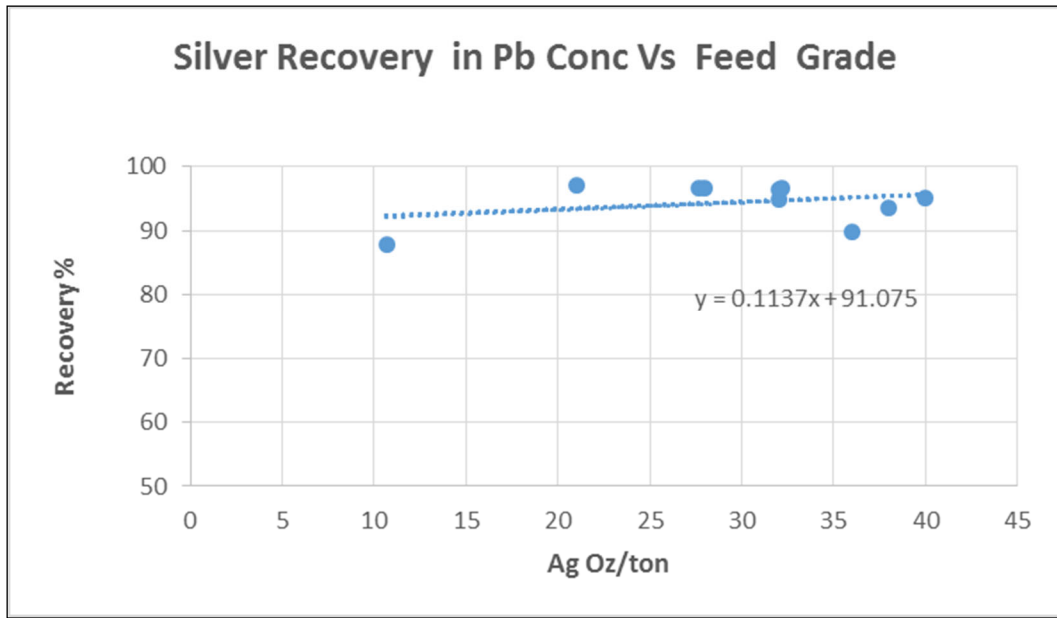

Source: SRK, 2017

Figure 13-13: Silver Recovery into the Pb Concentrate vs. Feed Grade

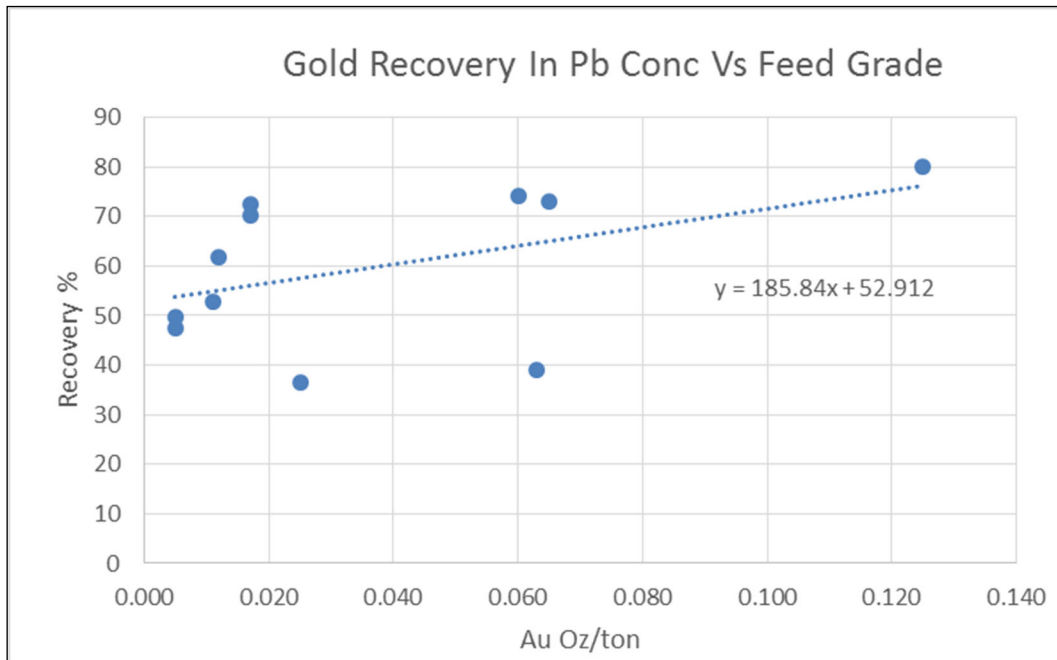

Source: SRK, 2017

Figure 13-14: Gold Recovery into the Pb Concentrate vs. Feed Grade

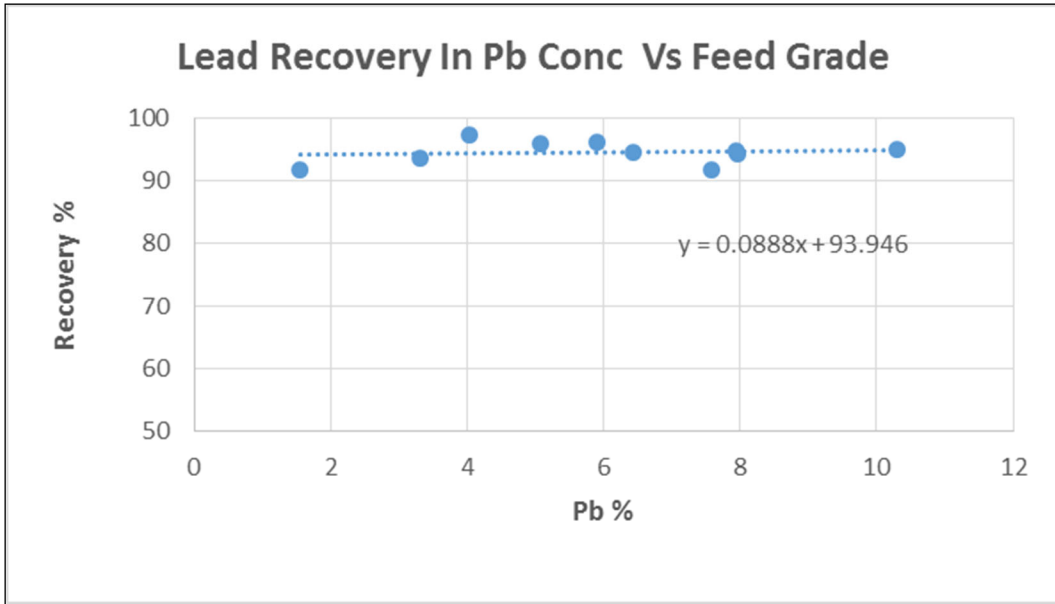

Source: SRK, 2017

Figure 13-15: Lead Recovery into the Pb Concentrate vs. Feed Grade

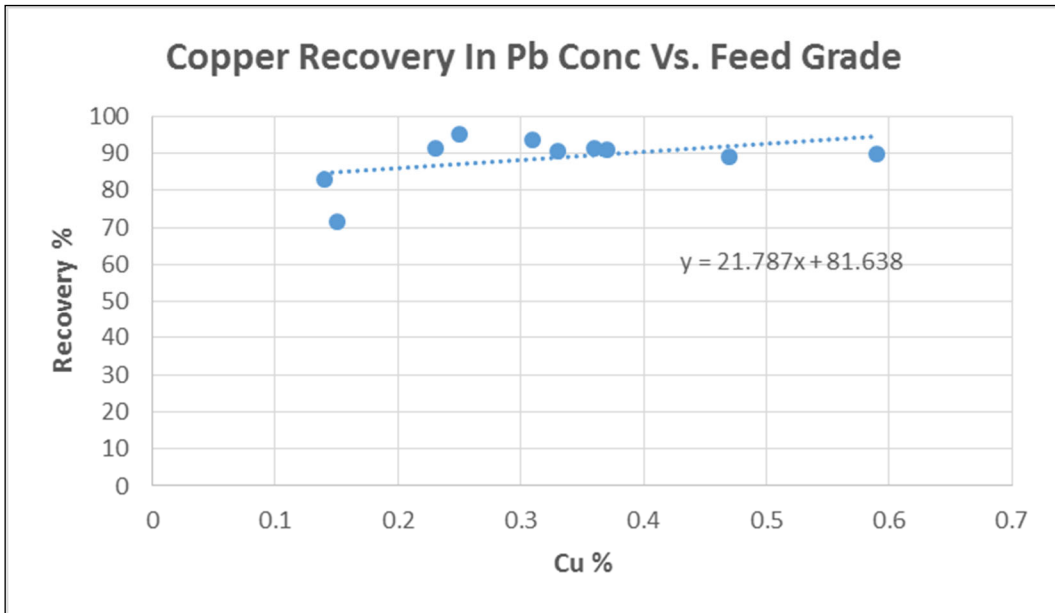

Source: SRK, 2017

Figure 13-16: Copper Recovery into the Pb Concentrate vs. Feed Grade

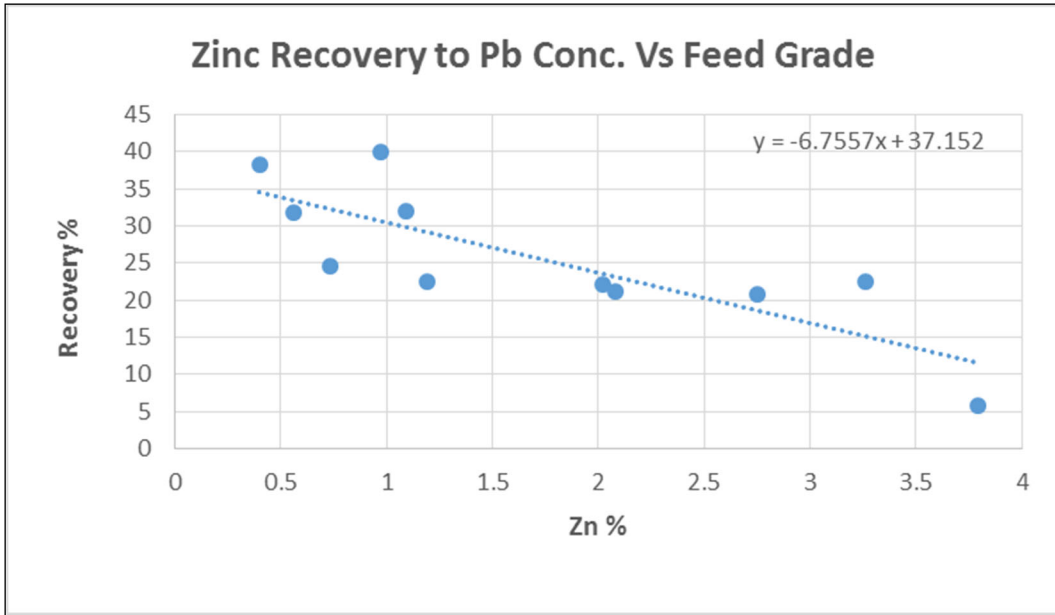

Source: SRK, 2017

Figure 13-17: Zinc Recovery into the Pb Concentrate vs. Feed Grade

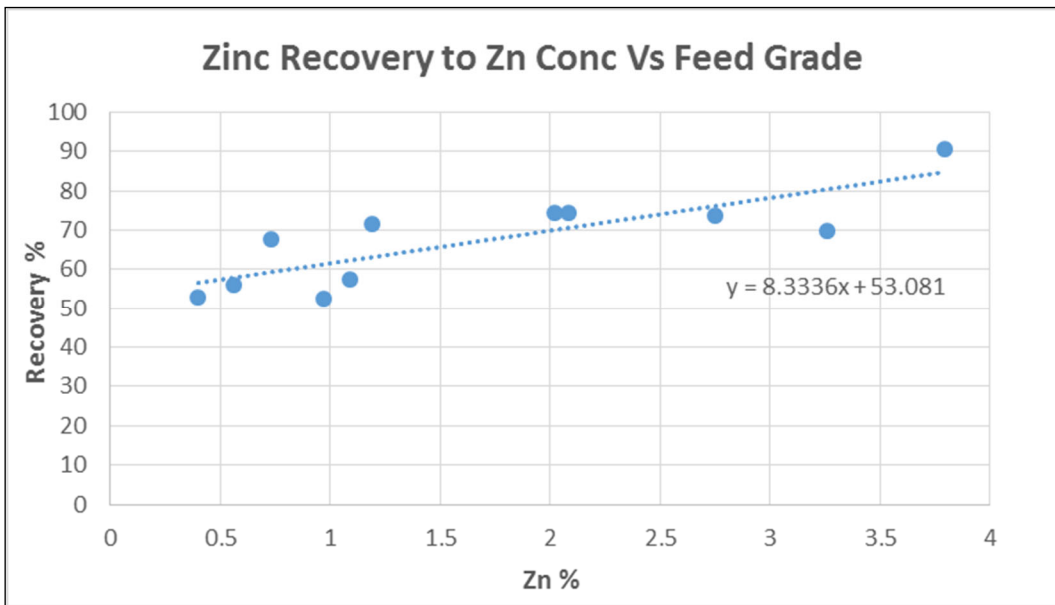

Source: SRK, 2017

Figure 13-18: Zinc Recovery into the Zn Concentrate vs. Feed Grade

Table 13-32: Estimated Metal Recoveries for the Virginius-Revenue Mine

Silver Recovery Estimate

Ore Grade Range (oz/st Ag)			
Low	10.0	20.0	30.0
High	20.0	30.0	47.0
Estimated Silver Recovery (%)			
Pb Conc.	93	94	95
Zn Conc.	1	1	1

Gold Recovery Estimate

Ore Grade Range (oz/st Au)			
Low	0.005	0.040	0.079
High	0.040	0.079	0.100
Estimated Gold Recovery (%)			
Pb Conc.	58	63	68
Zn Conc.	6	5	4

Lead Recovery Estimate

Ore Grade Range (Pb %)			
Low	1.0	2.1	5.0
High	2.1	5.0	8.5
Estimated Lead Recovery (%)			
Pb Conc.	94	94	95
Zn Conc.	1	1	1

Copper Recovery Estimate

Ore Grade Range (Cu %)			
Low	0.06	0.20	0.30
High	0.20	0.30	0.50
Estimated Copper Recovery (%)			
Pb Conc.	84	87	91
Zn Conc.	2	2	2

Zinc Recovery Estimate

Ore Grade Range (Zn %)			
Low	0.5	1.2	3.0
High	1.2	3.0	5.0
Estimated Zinc Recovery (%)			
Pb Conc.	31	23	10
Zn Conc.	60	71	86

Source: SRK, 2017

13.5 Process Design Parameters

Flotation reagent requirements and dosages and the basic process design parameters developed during the metallurgical program are presented in Table 13-33 and Table 13-34, respectively.

Table 13-33: Reagent Usage and Dosage Requirements for Processing Virginius Main Ore

Reagent	Reagent Dosages (lb/st ore)							Comment
	Pb Rougher	Zn Rougher	Pb CI-1	Pb CI-2	Zn CI-1	Zn CI-2	Total	
Zinc Sulfate	0.50		0.03				0.53	Added to grinding
Sodium Metabisulfite	0.50		0.03				0.53	Added to grinding
Cytec 3418A	0.015		0.005				0.02	Stage added
Cytec 242	0.01						0.01	Stage added
Cytec 549 (Glycol Frother)	0.15	0.03	0.04	0.01	0.01		0.23	Stage added
Lime (Ca (OH) ₂)		5.0			0.35	0.014	5.36	First Conditioner (pH 11.9)
Copper Sulfate		0.25					0.25	Second Conditioner
Sodium Isopropyl Xanthate		0.03			0.01		0.04	Second Conditioner
Hychem 309 (Flocculant)		0.06		0.002		0.001	0.063	

Source: FLSmidth, 2016 and 2017

Table 13-34: Key Process Design Parameters

Process Area	Units	Parameter
Crushing		
Ore		
Specific Gravity		2.91
Bond Low Impact Crushing Index (CWi)	kWh/st	6.1
Abrasion Index (Ai)		0.267
Dilution Waste		
Specific Gravity		2.73
Bond Low Impact Crushing Index (CWi)	kWh/st	14.4
Abrasion Index (Ai)		0.057
Grinding		
RWi ⁽¹⁾	kWh/st	14.0
BWi ⁽²⁾	kWh/st	15.7
Primary Grind Size	P80 µm	130
Flotation		
Lead Rougher/Scavenger		
Slurry Density	%	30
Condition	minutes	2
Laboratory Flotation Retention Time	minutes	8
Plant Flotation Retention Time (x 2.5 factor)	minutes	20
Zinc Rougher/Scavenger		
pH Condition	minutes	5
CuSO ₄ Condition	minutes	5
Laboratory Flotation Retention Time	minutes	5
Plant Flotation Retention Time (x 2.5 factor)	minutes	12.5
Lead Cleaner-1		
Laboratory Retention Time	minutes	5
Plant Retention Time (x 2.5 factor)	minutes	12.5
Lead Cleaner-2		
Laboratory Retention Time	minutes	3
Plant Retention Time (x 2.5 factor)	minutes	7.5
Zinc Cleaner-1		
Laboratory Retention Time	minutes	3
Plant Retention Time (x 2.5 factor)	minutes	7.5

Table 13-34: Key Process Design Parameters (continued)

Process Area	Units	Parameter
Zinc Cleaner-2		
Laboratory Retention Time	minutes	3
Plant Retention Time (x 2.5 factor)	minutes	7.5
Thickening		
Flotation Tailings		
Unit Area ⁽³⁾	m ² /st/d	0.045
Flocculant dosage	g/st	20 - 25
Underflow density	%	60 - 65
Rise rate	m/h	16
Lead Conc.		
Unit Area ⁽³⁾	m ² /st/d	0.1
Flocculant dosage	g/st	10
Underflow density	%	80
Rise rate	m/h	1-1.5
Filtration		
Flotation Tailings		
Filter Type		Pressure
Pressure	bar	9.7
Filtration rate	kg/m ² /h	150 - 250
Cycle time	minutes	12.2 - 20
Cake Moisture	%	14.2 - 15.5
Lead Conc. ⁽⁴⁾		
Filter Type		Pressure
Pressure	bar	10
Filtration rate	kg/m ² /h	790 - 1270
Cycle time	minutes	4.8 - 7.6
Cake Moisture	%	2.7 - 11

Source: FLSmidth and SRK

¹Hardest reported during feasibility program.

²Feasibility master composite.

³Does not include any scale-up factors.

⁴FLSmidth estimate from PneumaPress Test Results.

13.6 Significant Factors

A representative sub-sample of the Master composite that had been ground to the target grind of P80 130 µm was examined by XRD and AMA for mineralogy, locking/liberation analyses and trace mineral detection. Lead was found to occur as galena, zinc was found to occur as sphalerite and copper was found to occur primarily as chalcopyrite and tetrahedrite. Tetrahedrite and polybasite were identified as the primary silver-bearing minerals in the Master composite with tetrahedrite accounting for about 75% the silver and polybasite accounting for about 25% of the silver.

RWi and BWi determinations were made on each of the variability composites and the master composites. The RWi determinations were conducted with a closing screen of 1,180 µm and resulted in RWi determinations that ranged from 11.7 to 14.0 kWh/st for the variability composites and 12.9 kWh/st for the master composite. The BWi determinations were conducted with a 180 µm closing screen and ranged from 13.7 to 16.2 kWh/st for the variability composites and 15.6 kWh/st for the master composite. It is noted that these determinations are slightly lower than what was reported for the test composites used in the PFS.

A primary grind size of P80 130 µm was established as the target grind size.

Regrind testwork demonstrated that regrinding of the lead rougher concentrate prior to cleaner flotation was not required.

Locked cycle testwork on the master composite demonstrated that 94.7% of the lead, 94.8% of the silver, 91.4% of the copper and 74.2% of the gold were recovered into a lead cleaner concentrate that contained 70.3% Pb, 286 oz/st Ag, 3.07% Cu and 0.41 oz/st Au. Zinc flotation resulted in the recovery of 72.9% of the zinc, 1.3% of the silver and 2.0% of the gold into a zinc cleaner concentrate that contained 57.5% Zn, 16 oz/st Ag and 0.048 oz/st Au.

A linear regression of metal recovery versus ore grade was performed for relevant locked-cycle and large-batch tests conducted during both the FS and PFS metallurgical programs and resulted in the following observations regarding metal recovery:

- Silver recoveries achieved during the FS metallurgical program were similar to the PFS with recoveries into the lead concentrate ranging from 93% to 95% depending on feed grade
- Gold recovery into the lead concentrate ranges from 57% to 68% with an additional 4% to 6% recovery into the zinc concentrate depending upon feed grade
- Lead recovery into the lead concentrate is very consistent at 94% to 95% and relatively independent of feed grade
- Copper recovery into the lead concentrate ranges from 85% to 91% depending upon feed grade
- Zinc recovery into the zinc concentrate is estimated at 60% to 86% depending upon feed grade

Multi-element analyses were conducted on the final lead and zinc concentrates produced from Locked-cycle tests on the master composite. Significant quantities of arsenic and antimony were found in the lead concentrate. The zinc concentrate contained significant levels of arsenic and cadmium.

14 Mineral Resource Estimate

Prior to 2012, Mineral Resource and Reserve estimates at the Project were conducted using polygonal methods. Computer-based methods completed by Sunshine, made use of the Techbase software package. In 2012 and 2013, SRK conducted an initial geological model and mineral resource estimate using Vulcan software. The geological model at the time was based on an assumed minimum mining width for a shrinkage stope methodology (based on Star Mines' request at the time) and therefore is not applicable for all mining methods being considered in the current study.

Between 2015 to 2017, SRK has worked with OSMI to add sufficient levels of geological knowledge to start developing a geological based model, which has sufficient dilution information in the hangingwall and footwall to enable a detailed mine planning study to be completed.

Due to the uncertainties in the 2020/21 sampling programs no updates have been made to the geological model since the previous estimates, and the 2017 block models have been used as the basis for the current estimates. SRK has reviewed and updated the NSR calculations to reflect the latest market conditions and accounted for the current depletion. Based on these revisions the effective date of the current estimates is considered to be December 31, 2021.

14.1 Database

14.1.1 Coordinate Systems

The Project is in a local coordinate grid system in feet. All claims are located in both the local coordinate grid system and Colorado State Plane South, NAD 27 foot (State Plane). SRK has used the validated 2017 database for the basis for the current estimate.

14.1.2 Topography

During 2013, Star Mines acquired a topographic survey with 2.5 ft contours from satellite data. This survey covers the entire Project area and extending into Yankee Boy and Imogene Basins. The topography files had to be clipped for estimation purposes to the area over each deposit. Star Mines contracted PhotoSat to acquire Pleiades Satellite 50 centimeters (cm) (20 inches) high resolution imagery covering almost 40 square miles including and surrounding the Project area. Based on this imagery, PhotoSat produced topographic data with elevation contours down to 2.5 ft and delivered the imagery and contours in the Project's local coordinate system to facilitate integration with the existing digital data and ease of use by OSMI.

In 2013 SRK completed a review of the drillhole collars to the new topography and noted,

“Drillhole collars from Star Mines' 2012 and 2013 drilling programs were within ± 2 to 5 ft of the topography surface. However, some historic drillholes were up to ± 30 ft from the topographic surface. All surface drillholes were registered to the topography for modeling and estimation purposes. Once the historic drillholes were registered to the topography, the intercepts reconciled with nearby drilling and could be correlated within the vein. These drillholes were used in resource estimation.”

SRK recommends that OSMI continue to review the collar information upon completion of any new surface topography as a validation exercise.

14.1.3 Drilling and Sampling Database

The bulk of drilling and channel sampling was completed prior to 1996 on the Virginius Vein. At Yellow Rose Vein, approximately 50% of the drilling is from 2012 and a total of 201 channel samples were collected by Star Mines. Core recoveries observed in the Star Mines drilling programs are +90%. Between 2014 and 2015 under the ownership of FRSM, a total of 608 channel samples were taken as part of the routine mine production. In 2016, OSMI completed 42 holes for over 7,700 ft of drilling from underground in the northern Virginius Vein area of the mine. Drilling was completed from four cross cuts, with the Virginius Main Vein intersected in all the holes.

Whilst drilling has been completed to target a number of the known structures at OSMI, the main focus for the geological modelling and Mineral Resource is considered to be focused in three main areas:

- Virginius Vein – Including Main Virginius Vein and dike, footwall structures and hangingwall mineralization
- Yellow Rose – Multiple structures but only one main mineralized vein
- Terrible North – Drilled from surface and at the proposed intersection of the Virginius and Terrible structures

The following sections provide a brief summary of the available information extracted from the database split by the Yellow Rose and the Virginius areas.

Yellow Rose

The drillhole database for the Yellow Rose contains both historic and modern data. There are 68 drillholes and 10 channel samples in the resource database collected prior to 1996. Of the historic drillholes, 46 were drilled from surface and 22 were drilled from underground. The 1996 data includes 10 channel samples - four collected at surface and six from underground. The core size during this period was NX with a diameter of 2.98 inches, and AQ and AW both with diameters of 1.89 inches.

In 2012, Star Mines conducted an exploration drilling program adding 56 drillholes to the database. Six of these were drilled from underground into the Wheel of Fortune area, four were drilled into the Silver Queen target area (two from underground and two from surface), and the remaining 46 drillholes were drilled into the Yellow Rose. Of these 46 drillholes, 20 were drilled from surface and 26 were drilled from underground (Table 14-1).

During 2013, Star Mines added nine surface drillholes and 151 channel samples to the Yellow Rose area. The surface drillholes were drilled as infill in widely spaced drilling. Of the 151 channel samples collected during 2013, 114 were collected from the main Yellow Rose Vein structure. These were collected from existing drifts and a stope development area. The other 37 samples were collected from adjacent structures and splays off the main Yellow Rose Vein (Table 14-2).

Because of proximity to the Yellow Rose Vein, drillholes targeting the Silver Queen and Wheel of Fortune drillholes have been included in the block model for the Yellow Rose. All 2012 and 2013 drilling was completed using NQ tools.

Table 14-1: Drilling Statistics for the Yellow Rose

Location	Year	No. of Drillholes	No. of Samples	Average Length (ft)	Minimum Length (ft)	Maximum Length (ft)	Total Feet Sampled	Total Feet Drilled
Yellow Rose	Pre-1996	68	272	2.1	0.1	9.8	570.4	20,206
	2012	46	319	2.3	0.6	8.7	996.5	18,591
	2013	9	53	2.3	0.4	6.0	122.0	3,771
Wheel of Fortune	2012	6	55	2.9	1.0	6.0	163.4	2,426
Silver Queen	2012	4	34	3.2	1.0	8.7	107.3	815
Total		133	733	2.56	0.1	9.8	1,959.6	45,809

Source: SRK, 2017

Table 14-2: Channel Sample Statistics for the Yellow Rose

Location	Year	No. of Samples	Average Length (ft)	Minimum Length (ft)	Maximum Length (ft)	Total Feet Sampled
Yellow Rose	Pre-1996	10	2.45	1.0	5.0	24.5
	2013	151	1.17	0.1	7.0	175.9
	2013 to 2015	272	1.99	0.1	6.2	479.8
Total		433	1.71	0.1	7.0	200.4

Source: SRK, 2017

Virginius Vein

The Virginius database is a combination of historic and modern data as well as channel and drillhole data. The core size prior to 1996 was AQ. Star Mines drilling beginning in 2012 was drilled with NQ tools. No drilling was completed between 2012 and 2015, with the focus on production sampling during this period. The 2016 drilling was completed by OSMI using NQ core diameter from underground drilling platforms. Drilling was completed from four exploration crosscuts using fan drilling patterns. A summary of the drilling and sampling statistics is shown in Table 14-3 and Table 14-4.

Table 14-3: Drilling Statistics for the Virginius

Location	Year	No. of Drillholes	No. of Samples	Average Length (ft)	Minimum Length (ft)	Maximum Length (ft)	Total Feet Sampled	Total Feet Drilled
Virginius	Pre-1996	232	627	1.25	0.1	6.2	786.3	60,830
	2012	14	164	2.26	0.7	7.1	370.1	9,118
	2013	20	194	1.90	0.8	5.0	368.5	11,554
	2016	42	650	0.94	0.1	2.0	611.9	7,730
Total		308	1635	1.30	0.1	7.1	2,136.8	89,232

Source: SRK, 2016

Table 14-4: Channel Sampling Statistics for Virginius

Location	Year	No. of Samples	Average Length (ft)	Minimum Length (ft)	Maximum Length (ft)	Total Feet Sampled
Virginius	Pre-1996	1,478	1.36	0.09	15.1	2,007.8
	2013	14	1.47	0.2	4.0	20.6
	2014 to 2015	370	0.89	0.1	5.0	330.7
	2016	59	0.76	0.2	1.7	44.6
Total		1,921.00	1.25	0.09	15.1	2,403.7

Source: SRK, 2016

14.2 Geologic Model

All veins were modeled using Seequent Leapfrog Geo™.

There is evidence that dikes and/or faults disrupt and offset the Virginius and the Yellow Rose Vein structures. For example, the Wheel of Fortune Vein is reported to offset the Yellow Rose Vein, and near the intersection between the Virginius and the Terrible Vein a possible offset is assumed causing difficulty in interpretation. SRK did not model faulting or dikes and SRK recommends that mapped faults and dikes be added to the geological model in these areas.

In 2015, SRK was commissioned by OSMI to review all the available historical data with key findings presented to OSMI in September 2015, which noted the following geological topics:

- Wireframes used to date had been based on grades and not the key geological features noted by historical miners
- A need for further drilling to increase the amount of Mineral Resource available for mine production
- Geotechnical work to advance the knowledge base on site

At the request of OSMI, SRK began work on capturing the historical level maps and cross sections into digital format and has geo-referenced over 16 level maps covering the revenue tunnel, 2210, 2350, 2550, 2700 levels and the Terrible drift (Figure 14-1). An additional 32 cross sections have been geo-referenced and checked for positioning against the existing underground development. Some local variation exists between the cross sections and the development, but SRK does not consider these differences to be material.

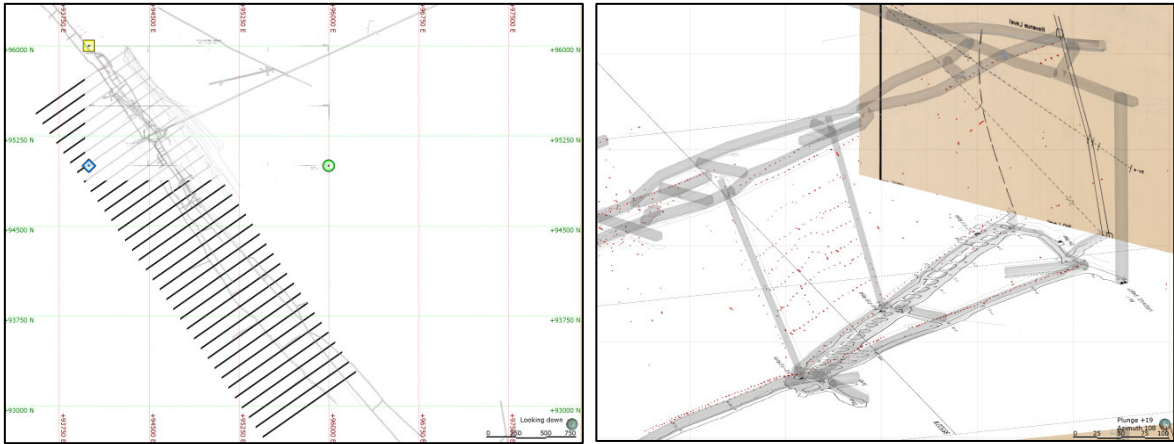

Source: SRK, 2016

Figure 14-1: Example of Geo-Referenced Historical Maps for the Virginius Vein

Yellow Rose was modeled as five individual veins, with a halo of lower grade mineralization around the main vein. These included the Yellow Rose Main Vein, splays off the main vein, structures parallel to the main vein and those north and east of the intersection (Figure 14-2).

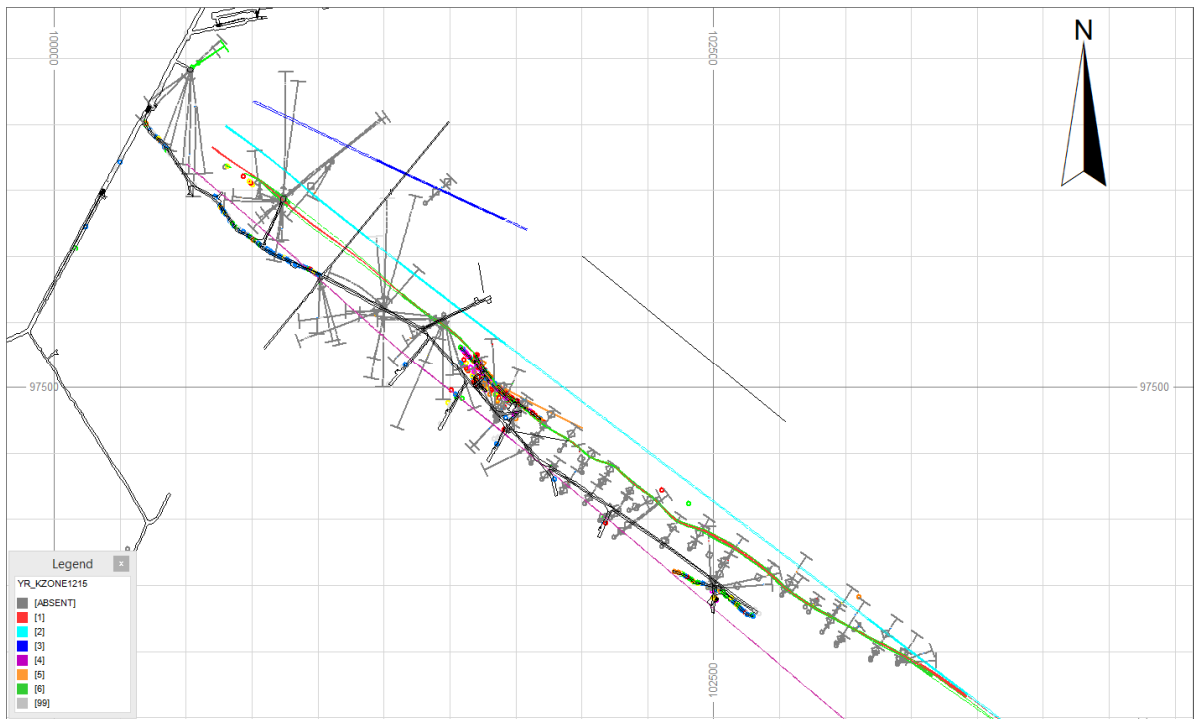

Source: SRK, 2017

Figure 14-2: Plan Showing Modelled Geological Domains (Veins) at Yellow Rose

The Virginius was modeled as four individual veins, with the dike unit acting as a guide to the main strike. The geological model has been created based on the geological logging codes from historical drilling logs with the latest logging modified to be consistent with this same format. The initial focus of the geological model has been to define the dike unit, which is the widest and most consistent unit

across the deposit. The dike forms the guideline to define both hangingwall and footwall structures. The Virginius Main Vein is typically hosted within the dike. Historically the Virginius Main Vein has been logged using three different lithological codes “V1VN”, “V2VN” and “V3VN”, to describe if the vein is hosted completely within the dike or sits on the footwall or hangingwall of the dike respectively. During the initial geological review in September 2015, SRK attempted to model these as three individual zones but, due to inconsistent sampling and less continuity in the V2VN and V3VN structures, it proved difficult to correlate between veins. During discussions with OSMI geological staff the decision has been taken to model the main structure using a combination of logging codes and grade. The resultant wireframes therefore move between all three sub-domains, but it is likely that the main mineralization grades may behave in a similar manner. Note that only a single structure has therefore been modelled to represent all three and there remains opportunity for additional mineralization to exist to a limited extent where parallel structures are mineralized. It is SRK’s opinion, this tonnage would have limited lateral and vertical extent, but good geological mapping and grade control sampling will improve the knowledge of continuity in these structures and define the minor splays of the Main Vein.

The Terrible Vein was modelled as an individual vein and split from the Virginius block model given its different strike orientation. The Terrible and Virginius are interpreted to intersect at the northern end of the Virginius modeled vein structures. The veins modeled for the Virginius and Terrible are listed in Table 14-5 and shown in Figure 14-3.

Table 14-5: Virginius Veins and Modelling Codes

Vein	KZONE
Virginius Main Vein	1
Dike	2
Footwall Vein	3
Hangingwall Vein	4
Terrible Vein	5

Source: SRK, 2017

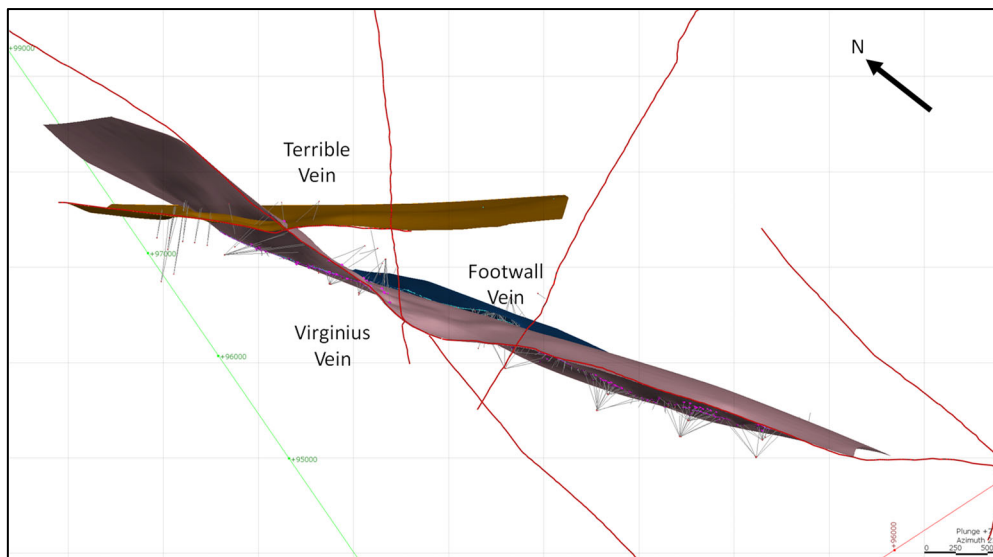

Source: SRK, 2017

Figure 14-3: Oblique View Showing Geological Domains (Veins) for the Virginius Vein

14.3 Assay Capping and Compositing

14.3.1 Outliers

The raw assay data for all metals was assessed by sample type for the presence of high-grade outlier values that could adversely impact grade estimation.

In previous estimates, zero or -999 was used for absent samples or samples below the detection limit. This was because there were multiple lower detection limits for analytical results throughout the history of the Project. For the current estimate, SRK applied a default value to absent, or grades below detection limit, set at ½ the lowest detection limit identified in the database. The following is a list of the values used for samples below the detection limit for both the Yellow Rose and the Virginius.

- Ag = 0.001 oz/st
- Au = 0.001 oz/st
- Cu = 0.001%
- Pb = 0.001%
- Zn = 0.001%

To complete the capping analysis, the SRK reviewed the sample distribution for each vein on a case-by-case basis. The raw gold, silver, lead, copper and zinc assay data for each of the veins were plotted on cumulative distribution graphs to understand the basic statistical distributions and to access appropriate capping levels.

To check the validity of the selected cap for each of the metals in each of the veins, the cumulative distribution curves illustrate a continuous population set with a slight break in slope and distribution at the upper levels. Above this level, the data distribution is more erratic and less continuous.

To complete the review of the capped samples SRK has imported the coded raw samples into Snowden Supervisor Software (Supervisor) for analysis. SRK has reviewed histograms, log histograms, log probability plots and charts reviewing mean grade versus capping value to identify any key breaks in the trend.

After review of log probability plots for all domains, SRK decided to cap the metals in both veins based on the values shown in Table 14-6. SRK has not updated the capping during the current estimation process.

Table 14-6: Assay Capping by Deposit

Area	Domain	Au (oz/st)	Ag (oz/st)	Pb (%)	Cu (%)	Zn (%)
Virginius ⁽¹⁾	Kzone1	0.85	300	35	2.0	11.5
	Kzone2	0.20	10	5	3.0	8.0
	Kzone3	0.60	325	35	0.5	8.0
	Kzone4	0.60	200	35	3.0	8.0
	Kzone5	0.60	300	35	3.0	8.0
Yellow Rose	Kzone1	0.35	115	19.5	1.0	10.0
	Kzone2	0.30	20	2.5	0.5	2.5
	Kzone3	0.30	20	2.5	0.5	2.5
	Kzone4	0.30	20	2.5	0.5	2.5
	Kzone5	0.30	20	2.5	0.5	2.5
	Kzone6	0.30	20	2.5	0.5	2.5

Source: SRK, 2022

(1) Virginius analysis is inclusive of the Terrible vein (kzone5).

A comparison between the raw and capped sampling is in Table 14-7, for the Terrible, Yellow Rose and Virginius veins.

Table 14-7: Summary of Raw vs. Capped Values for Estimated Veins (Absent Values Reset to Detection)

Statistic	RAW DATA									CAPPED VALUES						% Difference Mean
	Assay	Samples	Minimum	Maximum	Mean	Std Dev	CV	99 th Percentile	Samples	Minimum	Maximum	Mean	Std Dev	CV	0.99	
all	Au	5,620	0.001	24.52	0.00	0.07	22.55	0.05	5620	0.001	0.85	0.03	0.07	2.60	0.32	866.67%
Main Vein	Au	1,623	0.001	9.42	0.08	0.31	4.12	0.70	1623	0.001	0.85	0.06	0.11	1.84	0.85	-18.42%
FW Vein	Au	485	0.001	1.33	0.04	0.11	2.62	0.58	485	0.001	0.60	0.05	0.09	1.72	0.52	16.28%
Terrible	Au	138	0.001	0.76	0.06	0.09	1.58	0.54	138	0.001	0.60	0.06	0.09	1.39	0.52	3.33%
Yellow Rose	Au	595	0.001	4.50	0.06	0.27	4.51	0.40	595	0.001	0.35	0.04	0.07	1.54	0.35	-26.67%
Statistic	Assay	Samples	Minimum	Maximum	Mean	Std Dev	CV	99 th Percentile	Samples	Minimum	Maximum	Mean	Std Dev	CV	0.99	% Difference Mean
all	Ag	5,620	0.001	1085.00	0.75	10.49	13.98	15.59	5620	0.001	325.00	0.68	8.56	12.67	14.70	-9.99%
Main Vein	Ag	1,623	0.001	535.00	24.89	46.32	1.86	229.52	1623	0.001	300.00	24.36	42.22	1.73	229.52	-2.11%
FW Vein	Ag	485	0.001	1085.00	45.20	94.78	2.10	489.84	485	0.001	325.00	40.74	68.67	1.69	325.00	-9.87%
Terrible	Ag	138	0.001	109.50	3.17	9.89	3.12	46.33	138	0.001	109.50	3.17	9.89	3.12	46.33	0.00%
Yellow Rose	Ag	595	0.001	291.76	14.46	27.78	1.92	134.01	595	0.001	115.00	13.61	22.28	1.64	115.00	-5.85%
Statistic	Assay	Samples	Minimum	Maximum	Mean	Std Dev	CV	99 th Percentile	Samples	Minimum	Maximum	Mean	Std Dev	CV	0.99	% Difference Mean
all	Pb	5,620	0	67.40	0.14	1.49	10.44	4.01	5620	0	40.00	0.14	1.40	10.18	4.05	-3.52%
Main Vein	Pb	1,623	0.001	67.40	5.16	7.08	1.37	34.21	1623	0.001	40.00	5.12	6.81	1.33	34.21	-0.80%
FW Vein	Pb	485	0.001	60.65	6.10	9.57	1.57	45.74	485	0.001	40.00	5.96	8.98	1.51	40.00	-2.28%
Terrible	Pb	138	0	20.00	1.06	3.15	2.97	18.71	138	0	20.00	1.06	3.15	2.97	18.71	0.00%
Yellow Rose	Pb	595	0.001	38.00	3.12	5.53	1.78	27.85	595	0.001	19.50	2.91	4.63	1.59	19.50	-6.51%
Statistic	Assay	Samples	Minimum	Maximum	Mean	Std Dev	CV	99 th Percentile	Samples	Minimum	Maximum	Mean	Std Dev	CV	0.99	% Difference Mean
all	Cu	5,620	0.001	101.00	0.01	0.33	27.19	0.17	5620	0.001	3.50	0.01	0.10	11.03	0.17	-25.00%
Main Vein	Cu	1,623	0.001	6.98	0.30	0.65	2.17	2.81	1623	0.001	2.75	0.28	0.46	1.69	2.75	-8.64%
FW Vein	Cu	485	0.001	101.00	1.01	4.57	4.52	20.00	485	0.001	3.50	0.57	0.90	1.58	3.50	-43.81%
Terrible	Cu	138	0.001	1.27	0.02	0.08	5.37	0.18	138	0.001	1.27	0.02	0.08	5.37	0.18	0.00%
Yellow Rose	Cu	595	0.001	12.31	0.13	0.35	2.74	1.27	595	0.001	1.00	0.11	0.19	1.68	1.00	-11.81%
Statistic	Assay	Samples	Minimum	Maximum	Mean	Std Dev	CV	99 th Percentile	Samples	Minimum	Maximum	Mean	Std Dev	CV	0.99	% Difference Mean
all	Zn	5,620	0.001	720.00	0.07	2.81	42.59	1.70	5620	0.001	720.00	0.06	2.81	43.95	1.70	-3.03%
Main Vein	Zn	1,623	0.001	720.00	2.65	20.45	7.73	13.49	1623	0.001	720.00	2.65	20.45	7.73	13.49	0.00%
FW Vein	Zn	485	0.001	29.00	1.93	2.52	1.30	10.74	485	0.001	11.50	1.92	2.42	1.26	10.80	-0.83%
Terrible	Zn	138	0.001	3.41	0.23	0.57	2.51	2.89	138	0.001	3.41	0.23	0.57	2.51	2.89	0.00%
Yellow Rose	Zn	595	0.001	26.00	1.84	2.25	1.22	10.00	595	0.001	10.00	1.80	2.07	1.15	10.00	-1.80%

Source: SRK, 2017

14.3.2 Compositing

SRK analyzed the mean length of the underground channel and drillhole samples (Figure 14-4) in order to determine appropriate composite lengths. Approximately 80% of the samples on the Yellow Rose are 3 ft or less with 60% exactly 2 ft. SRK composited the samples at 3 ft lengths to standardize the length for resource estimation for Yellow Rose. The composites were broken against the vein solids generated by SRK.

On the Virginius, approximately 85% of the samples are 2 ft or less and 60% are approximately 1 ft. On the Virginius, SRK composited the samples at 2 ft lengths and the composites were broken against the vein solids. Table 14-8 present the statistics for final capped composites for the Yellow Rose and the Virginius, respectively.

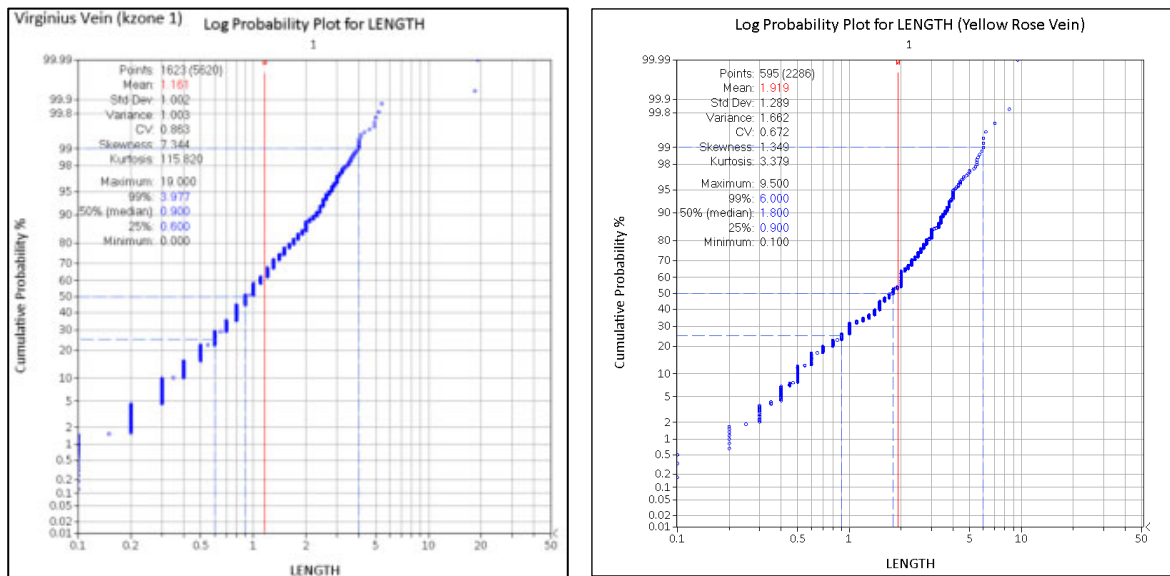

Source: SRK, 2017

Figure 14-4: Log Probability of Sample Lengths in Veins for the Virginius Vein (kzone1) and Yellow Rose Vein

Table 14-8: Summary Statistics of Composited Values in Main Veins

Statistic	Assay	Samples	Minimum (oz/st)	Maximum (oz/st)	Mean (oz/st)	Std Dev	CV	99 th Percentile	% Difference Mean
All	Au	52,954	0.001	0.85	0.00	0.02	6.91	0.05	0.00%
Main Vein	Au	1,786	0.001	0.85	0.06	0.10	1.66	0.63	-17.11%
FW Vein	Au	554	0.001	0.60	0.04	0.09	2.17	0.58	-6.98%
Terrible	Au	187	0.001	0.60	0.06	0.08	1.43	0.52	-3.33%
Yellow Rose	Au	637	0.001	0.35	0.04	0.07	1.50	0.35	-26.67%
Statistic	Assay	Samples	Minimum (oz/st)	Maximum (oz/st)	Mean (oz/st)	Std Dev	CV	99 th Percentile	% Difference Mean
All	Ag	52,954	0.001	325.00	0.68	8.51	12.60	14.29	-9.99%
Main Vein	Ag	1,786	0.001	300.00	24.37	41.89	1.72	214.77	-2.09%
FW Vein	Ag	554	0.001	325.00	40.75	68.37	1.68	325.00	-9.84%
Terrible	Ag	187	0.096	109.50	3.17	9.86	3.11	55.14	0.00%
Yellow Rose	Ag	637	0.001	115.00	13.61	21.13	1.55	115.00	-5.85%
Statistic	Assay	Samples	Minimum (oz/st)	Maximum (oz/st)	Mean (oz/st)	Std Dev	CV	99 th Percentile	% Difference Mean
All	Pb	52,954	0	40.00	0.14	1.38	10.08	3.80	-3.52%
Main Vein	Pb	1,786	0.001	40.00	5.12	6.75	1.32	33.65	-0.81%
FW Vein	Pb	554	0.001	40.00	5.96	8.89	1.49	40.00	-2.30%
Terrible	Pb	187	0	20.00	1.06	3.06	2.88	18.71	0.00%
Yellow Rose	Pb	637	0.001	19.50	2.91	4.50	1.55	19.50	-6.54%
Statistic	Assay	Samples	Minimum (oz/st)	Maximum (oz/st)	Mean (oz/st)	Std Dev	CV	99 th Percentile	% Difference Mean
All	Cu	52,954	0.001	3.50	0.01	0.10	10.97	0.17	-25.00%
Main Vein	Cu	1,786	0.001	2.75	0.28	0.46	1.69	2.74	-8.64%
FW Vein	Cu	554	0.001	3.50	0.57	0.89	1.57	3.50	-43.81%
Terrible	Cu	187	0.001	1.27	0.02	0.08	5.36	0.18	0.00%
Yellow Rose	Cu	637	0.001	1.00	0.11	0.18	1.59	0.97	-7.94%
Statistic	Assay	Samples	Minimum (oz/st)	Maximum (oz/st)	Mean (oz/st)	Std Dev	CV	99 th Percentile	% Difference Mean
All	Zn	52,954	0.001	720.00	0.06	2.81	43.96	1.61	-3.03%
Main Vein	Zn	1,786	0.001	720.00	2.65	20.46	7.73	13.50	0.00%
FW Vein	Zn	554	0.001	11.50	1.92	2.41	1.26	10.80	-0.83%
Terrible	Zn	187	0.001	3.41	0.23	0.56	2.47	2.89	0.00%
Yellow Rose	Zn	637	0.001	10.00	1.80	1.97	1.09	9.35	-1.85%

Source: SRK, 2017

14.3.3 Declustering Channel Sampling

During the initial review by SRK in September 2015 and preliminary models, SRK noted the influence on the mean grades and potential block estimates by clustering of the channel sampling.

While the most common method of grade estimation, OK, inherently declusters the input data through the point-to-point covariance matrix, other estimation methods, such as inverse distance modelling, do not decluster the data for the purposes of estimation, and this can sometimes lead to biased results.

The drillhole sampling spacing typically ranges between 75 and 125 ft. In comparison, the channel sampling spacing ranges between 5 and 10 ft. Standard grade estimates form a striped effect out to the range of influence and do not represent the desired level of smoothing. Therefore, SRK concluded that for the purposes of grade estimation using inverse distance, there is a need to apply a data selection algorithm for estimation to ensure the channel sampling data does not overwhelm the drill sampling during the grade estimate and thus induce a bias.

SRK tested declustering using a number of methods, and selected an option within Datamine Mining Software, which uses a moving window and averages all the samples within a defined grid spacing to create the declustered mean for a given area. SRK has tested 25 ft x 25 ft grid, 50 ft x 50 ft grids, and 75 ft x 75 ft grids. SRK has run initial block estimates using all three scenarios and compared the results via visual comparisons on long sections of the composites (including declustered samples) and the resultant block estimates (Figure 14-5). Based on this process SRK has selected to use the 50 ft x 50 ft declustered channel sampling combined with the drillhole intersections during the final estimation runs, based on visual comparisons.

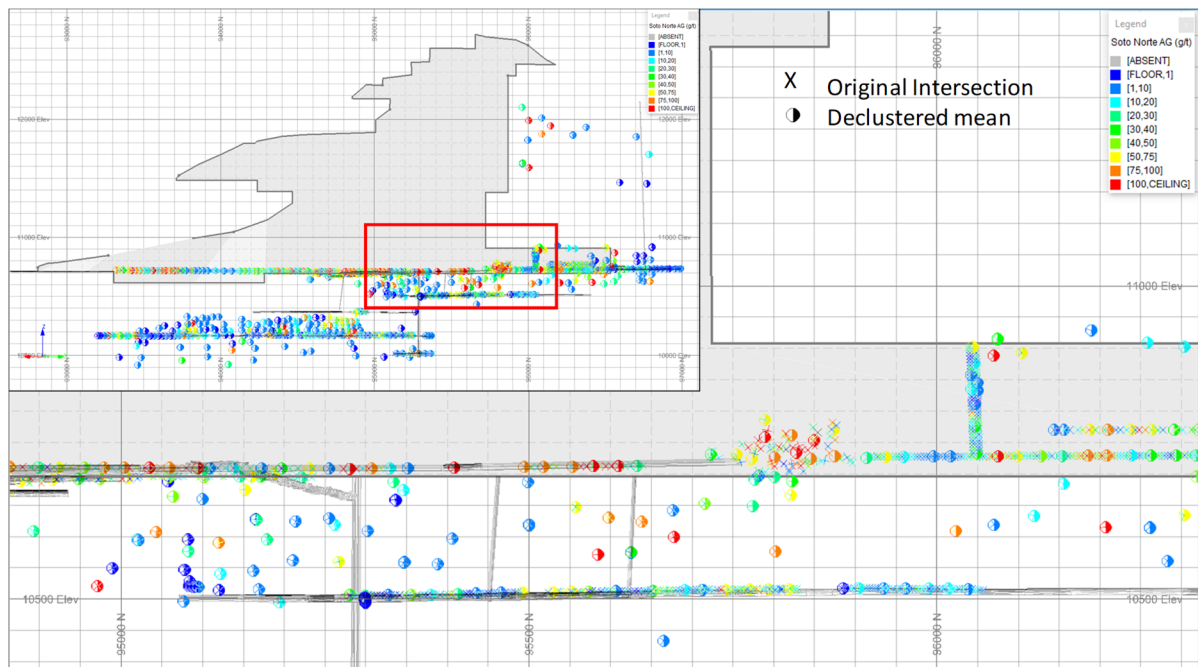

Source: SRK, 2017

Figure 14-5: Example of Declustering Investigation in KZONE 1, Showing Raw Samples as Crosses and Declustered Mean for Same Area as Points

14.4 Density

Prior to 2013, a tonnage factor of 12 ft³/st had been used based on documentation by Mayor (1971) for the Idarado Mine.

In 2013 determinations were made by measuring sample mass in air and water. A total of 27 measurements were made on Yellow Rose core samples: 17 in waste and 10 in mineralization (Table 14-9). The average for all samples is 10.91 ft³/st. Mineralization averaged 10.70 ft³/st and waste averaged 11.04 ft³/st. In 2014, a measurement program reportedly gave results of 9.6 ft³/st for vein material and 11.7 ft³/st for volcanic rock.

During the 2016 drill program, testing a northern portion of the Virginius vein, OSMI personnel took density reading from within the mineralized vein and the volcanic rock bounding the veins. The determinations resulted from measuring sample mass in air and in water. A summary of the density measurements and the associated tonnage factors is shown in Table 14-10. Data from 38 vein samples with averaged 11.0 ft³/st and 71 samples of volcanic material averaged 11.7 ft³/st.

Table 14-9: Summary of Density Sampling in Yellow Rose Drilling

Hole ID	From	To	Density (g/cm ³)	Tonnage Factor (ft ³ /st)	Visual % Sulfides	Au (oz/st)	Ag (oz/st)	Pb %	Cu %	Zn %	Average Tonnage Factor (ft ³ /st)	Material
YR-63	250	250.5	4.13	7.76	<3	0.004	0.04	0.037	0.002	0.08	12.0	WR/Waste
YR-63	255	255.5	2.54	12.60	<2	0.029	1.04	0.049	0.026	0.107		WR/Waste
YR-63	259	259.5	2.57	12.46	4	0.013	32.23	6.1	0.301	2.41		Vein
YR-63	263	263.5	2.59	12.35	<1	0.026	37.99	0.586	0.333	1.195		Vein
YR-63	269	269.5	2.89	11.07	4	0.021	14.83	0.838	0.095	2.45		Vein
YR-63	274	274.5	3.01	10.65	0	0.005	0.05	0.098	0.002	0.121		WR/Waste
YR-52	239	239.5	3.29	9.74	11	0.015	0.23	0.007	0.002	0.033	9.6	WR/Waste
YR-52	249	249.5	2.31	13.85	3	0.007	0.29	0.03	0.006	0.07		WR/Waste
YR-52	255	255.5	2.89	11.09	2	0.009	18.49	0.906	0.175	1.295		Vein
YR-52	258	258.5	3.97	8.07	85	0.015	4.51	12.1	0.076	12.25		Vein
YR-52	265	265.5	2.89	11.08	1	0.002	0.05	0.089	0.003	0.191		WR/Waste
YR-52	269	269.5	2.56	12.50	0	NA	NA	NA	NA	NA		WR/Waste
YR-75	280	280.5	2.75	11.65	<1	NA	NA	NA	NA	NA	10.7	WR/Waste
YR-75	288	288.5	3.14	10.19	0	0.127	4.20	0.072	0.100	0.112		Vein
YR-75	296	296.5	2.83	11.30	<2	0.031	0.44	0.341	0.006	0.488		WR/Waste
YR-75	298	298.5	2.98	10.73	5	0.004	45.50	1.630	0.697	3.580		Vein
YR-75	300	300.5	3.40	9.44	8	0.004	0.20	0.065	0.004	0.090		WR/Waste
YR-69	280	280.5	2.89	11.08	0	NA	NA	NA	NA	NA	12.4	WR/Waste
YR-69	284	284.5	3.15	10.16	2	0.004	0.00	0.004	0.002	0.016		WR/Waste
YR-69	287	287.5	2.58	12.43	2	0	14.90	0.655	0.149	2.55		Vein
YR-69	293	293.5	2.60	12.31	2	0.013	0.20	0.123	0.003	0.315		WR/Waste
YR-69	296	296.5	2.92	10.97	2	NA	NA	NA	NA	NA		WR/Waste
YR-71	389	389.5	2.99	10.71	4	0.017	0.41	1.04	0.006	1.535	9.6	WR/Waste
YR-71	391.5	392	4.17	7.68	82	0.008	2.74	16.6	0.013	3.59		Vein
YR-71	393	393.5	3.13	10.23	7	0.005	0	0.452	0.005	1.02		WR/Waste
YR-71	395	395.5	2.93	10.95	3	0.136	0.79	0.033	0.016	0.048		Vein
YR-71	404	404.5	2.77	11.56	0	NA	NA	NA	NA	NA		WR/Waste

Source: SRK, 2017

Table 14-10: Summary of 2016 Density Measurements by Rock Type

Rock Type	Count	Min	Max	Avg	Factor
Rhyodacite	26	2.56	2.78	2.71	11.83
Altered Andesite	23	2.50	2.92	2.75	11.68
Andesite	9	2.73	2.77	2.75	11.65
Altered Rhyodacite	13	2.49	2.77	2.68	11.95
Quartz Vein	38	2.53	3.74	2.91	11.00
Subtotal	109	2.49	3.74	2.79	11.49

Source: SRK, 2017

During 2021 OSMI completed a total of 65 density measurements. The sampling was completed using Archimedes principals of weight in air versus weight in water. The results have been converted from the specific gravity measurements to tonnage factors. The geologist recorded the sample location and expected material type based on the existing model. This has been broken down into, waste rock, country rock, mid-grade, high-grade and quality control (quartz crystal). The results of the analysis are shown in Table 14-11. Based on a review of the results SRK has selected to combine the mid and high-grade ore to use a single factor for all three block models. A factor of 10.04 ft³/st has been used for all veins.

Table 14-11: Summary of 2021 Density Testwork

	Count	Average (Tonnage Factor)
High Grade Ore	27	9.50
Mid-Grade Ore	7	12.11
Waste Rock	27	12.78
Country Rock	2	12.12
QTZ Control	2	12.43
High+Mid-Grade	34	10.04

Source: SRK, 2022

14.5 Variogram Analysis and Modeling

SRK completed variography on both the Virginius and Yellow Rose datasets but was unable to produce meaningful and interpretable directional variograms. SRK comments that the deposit has short scale variability which could be a function of a highly variable (nuggetty) style deposit. SRK has therefore selected an Inverse Distance methodology as the preferred estimation method. The semi-variograms generated in 2013 on the Yellow Rose deposit have been used to help guide search ranges on the vein.

14.6 Block Model

Datamine Studio RM Version 1.9.36.0 (Datamine) has been used for all block modelling and grade estimation. A sub-celled block model was constructed in Datamine for both the Virginius, Footwall Vein, Terrible and Yellow Rose Veins. Rotated blocks have been used to represent the predominant strike of each of the main vein structures with the rotations matched to OSMI local mine grid for ease of integration and mine planning purposes. The alignment of the block edges with the orientation of the mineralization and sub-celling provides better representation of the horizontal thickness of the veins. Given the close relationships between the Virginius Vein and the Footwall Vein a single model combining both of these has been used.

The model limits and extents for the three models (four veins in total) are provided in Table 14-12.

Table 14-12: Summary of Block Model Origin

Vein	Dimension Axis	Origin Coordinate	Block Size (ft)	Rotation (Z-Axis)	Number Blocks	Sub-Block (ft)
Yellow Rose	X	103140	Full Width	-50	1	Full Width
	Y	95630	25		175	1.0
	Z	10432	25		50	1.0
Virginius	X	95962	Full Width	-40	1	Full Width
	Y	92500	50		125	2.0
	Z	9681	50		70	2.0
Terrible	X	95500	Full Width	-60	1	Full Width
	Y	95250	50		90	2.0
	Z	9681	50		70	2.0

Source: SRK, 2021

14.7 Estimation Methodology

14.7.1 Virginius Vein

SRK has conducted a number of different estimation scenarios for the Virginius Vein during 2017 with the aim of testing the sensitivity to changes in estimation parameters and to produce a more robust estimate of the mean grades within different regions of the vein. A large block size of 50 ft x 50 ft was selected for use as the parent cell for estimation to produce a more smoothed estimate, compared to more discrete small block estimates, which may be overly influenced by local channel sampling variations using an ID2 algorithm. The search parameters have been rotated to fit the general dip and interpreted plunge of the mineralization. The average dip has been selected as 50° but is known to vary between 45° and 80° within various portions of the vein. To account for local variations SRK has used a large search range across the width of the veins to ensure all possible composites have been selected within the plane of the vein. The plunge of 15° has been based on a review of the long section and general trend noted within the historical long sections and sampling information available in Figure 14-6.

During the parameter sensitivity study, SRK tested the following scenarios:

25 ft x 25 ft x 25 ft Declustered Sampling

- ID2, Search Range 75 ft x 75 ft x 150 ft
- ID2, Search Range 75 ft x 75 ft x 100 ft
- ID2, Search Range 100 ft x 100 ft x 150 ft Rotated to 15-degree plunge
- ID3, Search Range 125 ft x 125 ft x 150 ft Rotated to 15-degree plunge

50 ft x 50 ft x 50 ft Declustered Sampling

- ID2, Search Range 75 ft x 75 ft x 150 ft
- ID2, Search Range 75 ft x 75 ft x 100 ft
- ID2, Search Range 100 ft x 100 ft x 150 ft Rotated to 15-degree plunge
- ID3, Search Range 125 ft x 125 ft x 150 ft Rotated to 15-degree plunge

75 ft x 75 ft x 75 ft Declustered Sampling

- ID2, Search Range 75 ft x 75 ft x 150 ft
- ID2, Search Range 75 ft x 75 ft x 100 ft
- ID2, Search Range 100 ft x 100 ft x 150 ft Rotated to 15-degree plunge

- ID3, Search Range 125 ft x 125 ft x 150 ft Rotated to 15-degree plunge



Source: SRK, 2021

Figure 14-6: Long Section, Showing Estimation Parameter Ellipse and Stope Outlines Looking Southwest

To evaluate the differences between the different estimates SRK completed both visual assessment and a quantitative assessment. The visual inspection indicated the best correlations occurred within the 75 ft x 75 ft x 150 ft and 100 ft x 100 ft x 150 ft scenarios. The quantitative assessment has been completed using defined polygons of potential mining areas supplied by OSMI. A common volume of 310,322 tons has been estimated in each scenario. The results indicate little variation between the various scenarios with the Ag (oz/st) grade ranging from 30.2 oz/st to 31.5 oz/st (Table 14-13), which is with a range of $\pm 5\%$, suggesting limited impact to change in parameters. SRK elected to use the 75 ft x 75 ft x 150 ft range search parameters in the final estimation process and are shown in Table 14-14.

In the footwall SRK does not consider the plunging features as well established and therefore has elected to use a tighter range (namely in the dip component 100 ft versus 150 ft). The final search also uses a minimum of 1 composite and maximum of four samples, with the vertical extent of the grade estimates limited manually to the revenue level.

In each case, the zoned sub-block centroids have been used to define the level of discretization with the results average back to a parent cell of 50 ft x 50 ft across the width of the vein. A nearest neighbor estimation was completed for comparison to the estimated grades for all key elements. A maximum of two samples per hole has been used in all estimates completed by SRK.

Table 14-13: Summary of Sensitivity Analysis on Parameters for Estimation on Virginius Vein

Volume (ft)	Min/Max Composites	Tons (st)	Au (oz/st)	Ag (oz/st)	Pb (%)	Zn (%)	Cu (%)	HTHK (ft)
75 x 75 x 150	3/10 all passes	310,322	0.08	31.5	6.1	2.9	0.31	1.67
100 x 100 x 150	3/10 all passes	310,322	0.08	30.9	6.0	2.9	0.31	1.67
125 x 125 x 150	3/10 all passes	310,322	0.07	30.2	5.9	2.9	0.30	1.67
75 x 75 x 100	3/10 (1/4 final pass)	310,322	0.08	30.5	6.0	2.9	0.30	1.67
75 x 75 x 100	3/10 (2/7 final pass)	310,322	0.07	30.6	6.0	2.9	0.30	1.67

Source: SRK, 2017

Table 14-14: Summary of Final Estimation Parameters for Virginius and FW Vein

Vein	Pass Number	Search Distance (ft)			Minimum Composite	Maximum Composites	Maximum per DDH	Sample Type(s) Used
		Down dip	Strike	Width				
Virginius	1	75	75	150	3	10	2	Channel (50 ft decluster) & DDH
	2	150	150	300	3	10	2	
	3	225	225	450	3	10	2	
FW	1	50	50	100	3	10	2	Channel (50 ft decluster) & DDH
	2	150	150	200	3	10	2	
	3	200	300	400	1	4	2	

Source: SRK, 2017

14.7.2 Terrible Vein

In the Terrible Vein the majority of the sampling is based on the drilling database with limited channel sampling to date. The resource was estimated in three passes using ID2. Each vein was estimated separately using the search distances, minimum and maximum composites and samples (composites) per drillhole listed in Table 14-15. SRK has used an isotropic search set to 125 ft to incorporate sampling from more than a single hole. A search range multiplier of 2 x range and 4 x range has been used to extend the estimates to a maximum distance of 500 ft from the current drilling and channel sampling, but the majority of the channel sampling is below the economic threshold on the Terrible Vein, at present.

Table 14-15: Summary of Final Estimation Parameters for Terrible Vein

Pass Number	Search Distance (ft)			Minimum Composites	Maximum Composites	Maximum per DDH	Sample Type(s) Used
	Down dip	Strike	Width				
1	125	125	125	3	10	2	Channel & DDH
2	250	250	250	3	10	2	Channel & DDH
3	500	500	500	1	4	2	Channel & DDH

Source: SRK, 2017

14.7.3 Yellow Rose

At Yellow Rose, the resource was estimated in three passes using ID2. Each vein was estimated separately using the search distances, minimum and maximum composites and samples (composites) per drillhole listed in Table 14-16. SRK has used an isotropic search for Yellow Rose and with the minor axis effectively controlled by the width of the vein. The search distance for the major and semi-major distance was based on a 2013 defined omni-directional variogram and drillhole spacing. The second pass is 150 ft x 150 ft, with a final pass of 375 ft x 375 ft used, and a reduction in the minimum and maximum number of composites used to 1 and 4 composites respectively. The short first range is to focus estimation around the underground channel sampling.

A nearest neighbor estimation was completed for comparison to the estimated grades for all key elements.

Table 14-16: Summary of Final Estimation Parameters for Yellow Rose Vein

Pass Number	Search Distance (ft)			Minimum Composite	Maximum Composite	Maximum per DDH	Sample Type(s) Used
	Down dip	Strike	Width				
1	75	75	75	3	10	10	Channel & DDH
2	150	150	150	3	10	10	Channel & DDH
3	375	375	375	1	4	10	Channel & DDH

Source: SRK, 2017

14.8 Model Validation

SRK has validated the block model using the following techniques:

- Visual inspection of block grades in comparison with drill hole data
- Sectional validation of the mean samples grades in comparison to the mean model grades
- Comparison of ID2 block model statistics with nearest neighbor (NN) block estimates and composite sample grades

14.8.1 Visual Comparison

Visual comparisons between the block grades and the underlying composite grades in plan and section show close agreement and indicates that the estimation was good. Long sections showing the comparison of the four veins estimated are shown in Figure 14-7.

Virginus Main Vein

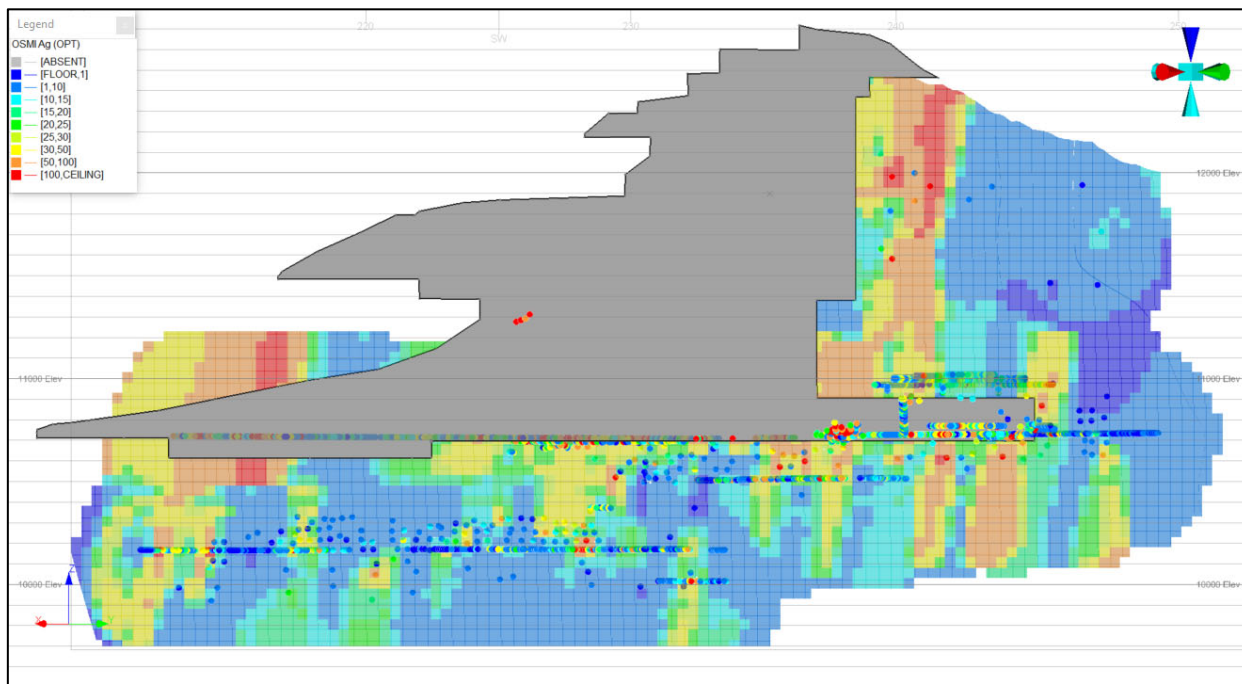

Footwall Vein

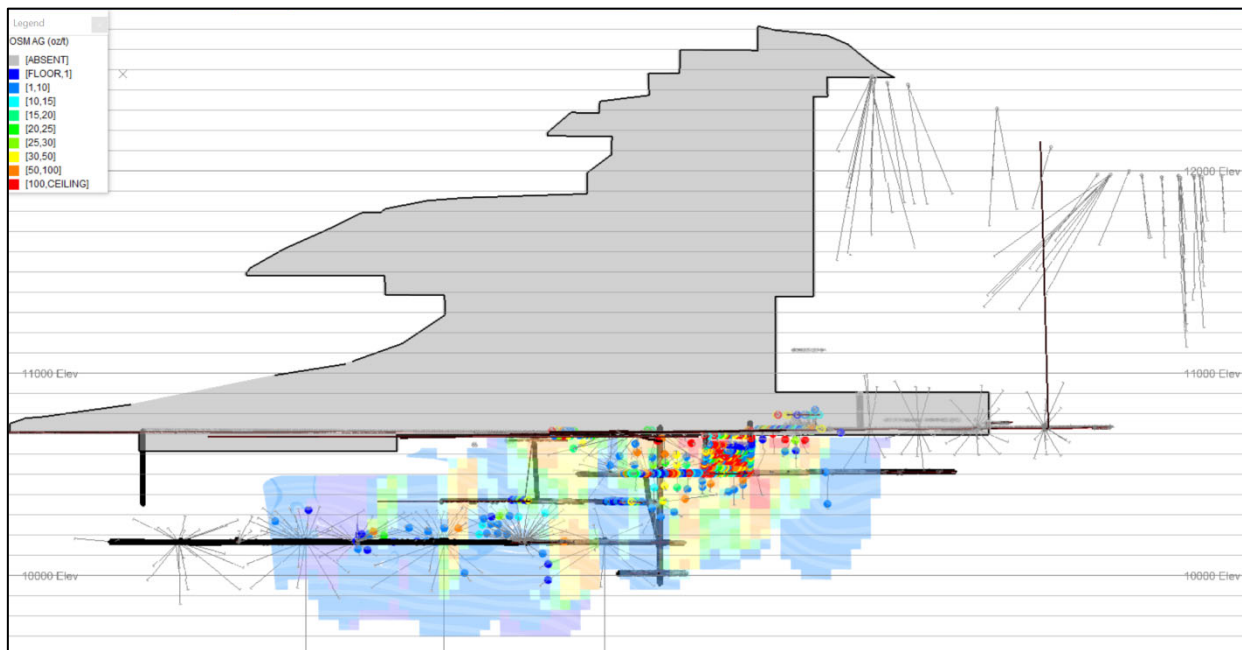

Terrible Vein

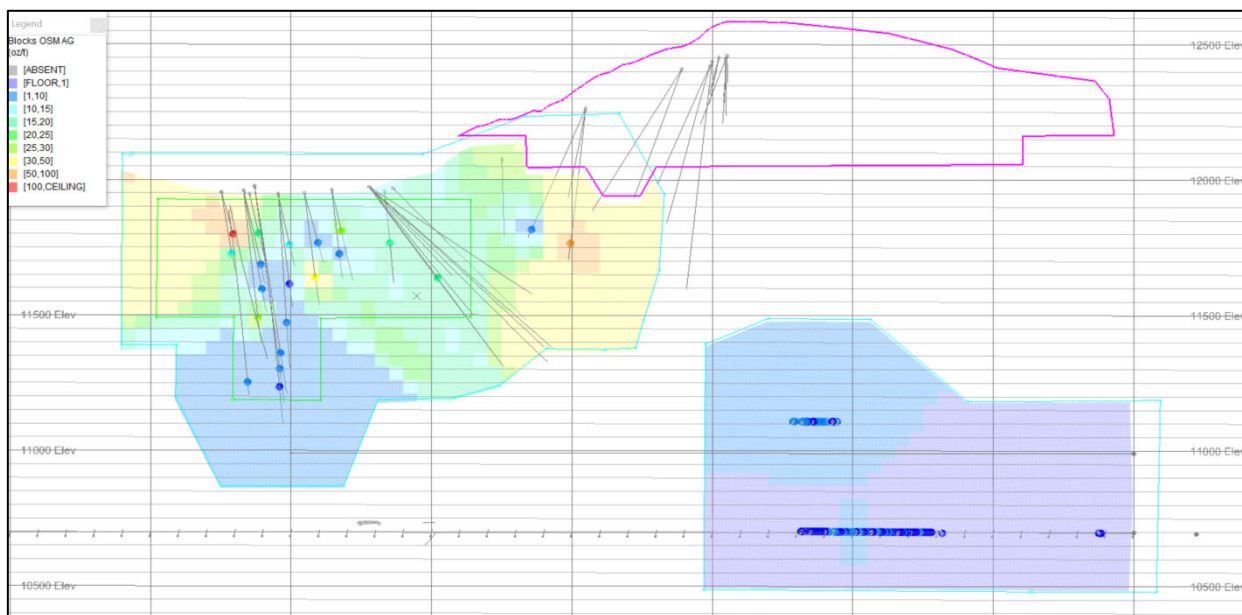

Yellow Rose Vein

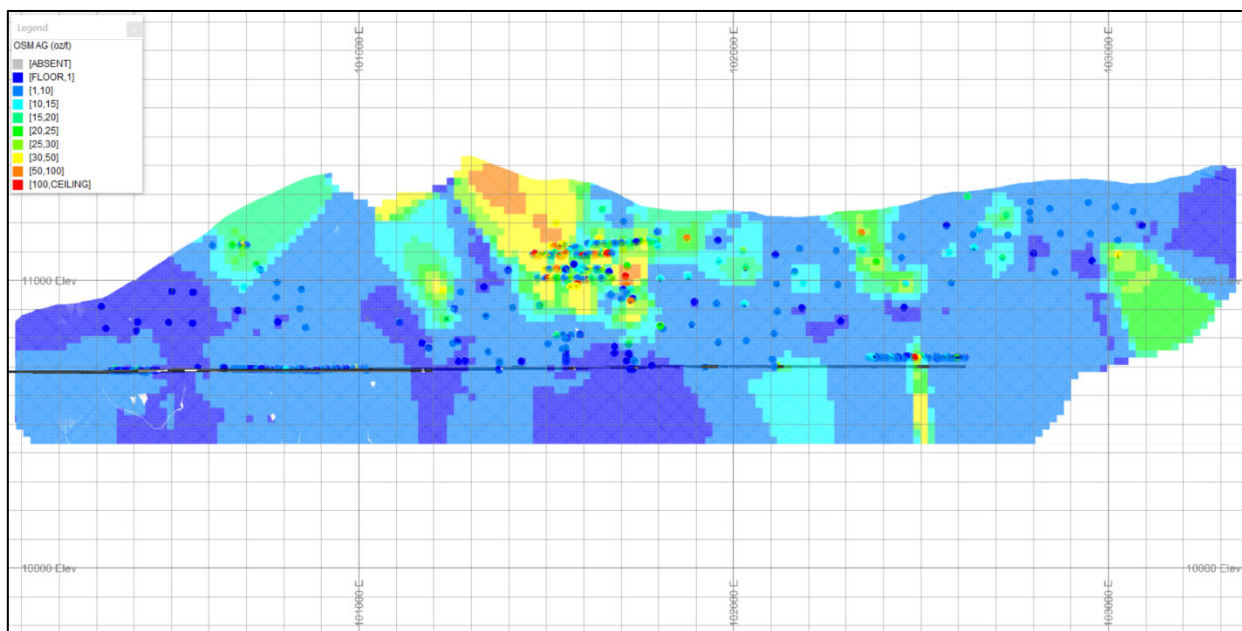

Source: SRK, 2022

Figure 14-7: Long Sections Showing Ag (oz/st) Estimates Versus Composite Grades

14.8.2 Comparative Statistics

SRK conducted statistical comparisons between the ID2, NN block estimates contained within the vein solids for all veins with the underlying composite grades used for each block model (Table 14-17). The differences between the block estimates and the raw statistics are typically high which SRK attributes to the clustering of the data from the channel sampling. SRK has therefore defined declustered means for each of the veins and elements. The block model average grades reported both higher and lower than composite grades, with the majority of the instances being lower. SRK has reviewed where differences occur and typically where higher differences are noted it is due to the current sampling spatial distribution, with lower grades at the edge of the vein being included in the block averages.

To provide an alternative comparison SRK has relied upon the correlation between the ID2 and NN as an assessment of the global mean of the deposit. A comparison between the two different estimates shows a reasonably strong correlation. The difference between ID2 and NN for Ag (oz/st) range from 0% to 10.2% in absolute difference terms which is within acceptable levels. The largest differences are noted within the Terrible and Yellow Rose Veins where the ID2 reports 10.2% lower than the NN at Terrible, and 9.6% higher at Yellow Rose.

The variability between the ID2 and NN estimates within the Au (oz/st) estimates is less than noted in Ag (oz/st). The range in terms of absolute percentage across the four veins is 7.8%, with the best correlation noted within the Virginius Vein, and the poorest performance in the Terrible Vein. The Pb and Zn estimates also perform well across all veins with the exception of Pb (%) in the Terrible Vein which reported a mean grade of 3.08% versus 2.74%, in the NN and ID2, respectively.

The worst performing estimates in terms of percentage difference are the Cu (%) estimates with the difference in the two estimates ranging between 6.7% and 19.4% between the four veins. Typically, the ID2 estimates is lower than the NN estimate in most cases, but the higher differences are also a function of the relatively low grades, at which minor changes have larger influence. A review of the mean grades shows the means vary from 0.30% to 0.34% in the Virginius and Footwall Veins, compared to 0.04% to 0.07% in the Terrible and Yellow Rose.

Overall SRK is comfortable that the correlation between the NN and ID2 are within of sufficient levels of error, for the current level of study. Infill drilling and sampling will be recommended to improve the correlations further, to provide higher levels of confidence (Measured), should additional development enable future sampling.

Table 14-17: Summary of Comparison between Composite (declustered) vs. ID2 and NN Block Estimates per Vein

Vein	Unit	Statistic	Composite	Declustered Composite	ID2	NN	ID2 vs Declustered %Diff	NN vs Declustered %Diff	ID2 vs NN %Diff
V1	Ag (oz/st)	Mean	26.4	24.9	22.3	22.1	-10.5	-11.3	0.9
		Std Dev	44.9	42.8	25.2	33.5			
		CV	1.7	1.7	1.1	1.5			
		Maximum	300	300	192	209.2			
	Au (oz/st)	Mean	0.061	0.064	0.059	0.058	-8.229	-8.785	0.61
		Std Dev	0.109	0.114	0.057	0.083			
		CV	1.772	1.78	0.961	1.417			
		Maximum	0.85	0.85	0.535	0.663			
	Pb (%)	Mean	5.29	4.92	4.24	4.1	-13.95	-16.73	3.35
		Std Dev	7.03	6.72	4.27	5.04			
		CV	1.33	1.37	1.01	1.23			
		Maximum	40	40	31.46	34.4			
	Zn (%)	Mean	2.42	2.11	2.09	1.98	-0.85	-5.85	5.3
		Std Dev	17.22	8.15	2.52	3.06			
		CV	7.12	3.87	1.2	1.54			
		Maximum	720	720	19.64	22.62			
Cu (%)	Mean	0.28	0.29	0.33	0.3	12.57	4.5	7.72	
	Std Dev	0.46	0.49	0.51	0.61				
	CV	1.65	1.68	1.56	2				
	Maximum	2.75	2.75	2.75	2.75				
FW	Ag (oz/st)	Mean	47.27	24.547	21.076	21.115	-14.143	-13.984	-0.18
		Std Dev	72.751	48.104	32.444	37.693			
		CV	1.539	1.96	1.539	1.785			
		Maximum	325	325	275.099	325			
	Au (oz/st)	Mean	0.046	0.042	0.032	0.03	-23.954	-28.344	6.13
		Std Dev	0.086	0.076	0.032	0.037			
		CV	1.88	1.829	1.011	1.225			
		Maximum	0.6	0.6	0.348	0.557			
	Pb (%)	Mean	7.45	6.06	3.83	3.69	-36.75	-39.18	3.99
		Std Dev	9.52	8.15	4.75	5.17			
		CV	1.28	1.34	1.24	1.4			
		Maximum	40	40	32.76	32.76			
	Zn (%)	Mean	2.24	1.84	1.35	1.34	-26.74	-27.38	0.87
		Std Dev	2.53	2.19	1.17	1.48			
		CV	1.13	1.19	0.87	1.1			
		Maximum	11.5	11.5	7.18	11.5			
Cu (%)	Mean	0.67	0.51	0.32	0.34	-37.34	-32.87	-6.67	
	Std Dev	0.94	0.8	0.44	0.57				
	CV	1.4	1.58	1.37	1.67				
	Maximum	3.5	3.5	3.44	3.5				
VT	Ag (oz/st)	Mean	3.53	10.09	9.11	10.15	-9.68	0.62	-10.24
		Std Dev	11.17	19.83	13.52	19.94			
		CV	3.16	1.97	1.48	1.96			
		Maximum	109.5	109.5	82.56	109.5			
	Au (oz/st)	Mean	0.07	0.06	0.07	0.08	13.28	22.9	-7.83
		Std Dev	0.09	0.07	0.04	0.06			
		CV	1.39	1.18	0.58	0.77			
		Maximum	0.6	0.6	0.22	0.22			
	Pb (%)	Mean	1.08	4.8	2.74	3.08	-43.04	-35.96	-11.04
		Std Dev	3.25	6.41	4.09	5.31			
		Variance	10.55	41.15	16.69	28.23			
		CV	3.02	1.34	1.49	1.73			
	Zn (%)	Mean	0.19	0.77	0.57	0.57	-25.84	-25.35	-0.65
		Std Dev	0.56	0.95	0.69	0.75			
		CV	2.93	1.24	1.21	1.31			
		Maximum	3.41	3.41	3.01	3.41			
Cu (%)	Mean	0.02	0.07	0.04	0.06	-34.94	-19.26	-19.42	
	Std Dev	0.1	0.21	0.1	0.19				
	CV	6	2.97	2.25	3.38				
	Maximum	1.27	1.27	0.95	1.27				
YR	Ag (oz/st)	Mean	13.3	8.94	8.78	8.01	-1.75	-10.33	9.56
		Std Dev	22.41	16.35	10.42	11.5			
		CV	1.68	1.83	1.19	1.43			
		Maximum	115	115	79.99	114.25			
	Au (oz/st)	Mean	0.04	0.03	0.03	0.03	-17.66	-19.15	1.84
		Std Dev	0.07	0.05	0.02	0.03			
		CV	1.51	1.47	0.86	1.26			
		Maximum	0.35	0.35	0.21	0.27			
	Pb (%)	Mean	2.79	1.84	1.43	1.49	-22.32	-18.6	-4.57
		Std Dev	4.61	3.46	1.99	2.46			
		CV	1.65	1.89	1.39	1.65			
		Maximum	19.5	19.5	16.3	18.23			
	Zn (%)	Mean	1.75	1.37	1.22	1.28	-11.17	-6.5	-4.99
		Std Dev	2.03	1.68	0.99	1.44			
		CV	1.16	1.22	0.81	1.13			
		Maximum	10	10	7.15	10			
Cu (%)	Mean	0.11	0.11	0.07	0.06	-34.29	-41.74	12.79	
	Std Dev	0.19	0.19	0.08	0.09				
	CV	1.73	1.75	1.15	1.48				
	Maximum	1	1	0.69	0.99				

Source: SRK, 2022

14.8.3 Swath Plots

As part of the validation process, the input composite samples are compared to the block model grades within a series of coordinates (based on the principal directions). The results of which are then displayed on charts to check for visual discrepancies between grades.

Figure 14-8 show the results for the grades for all the key elements for the Yellow Rose and Virginius main domains of interest (kzone=1) based on section lines cut along strike.

The resultant plots show a reasonable correlation between the block model grades and the composite grades, with the block model showing a typically smoothed profile of the composite grades as expected. The composite grades appear to be more variable (saw-tooth) than the estimated blocks, which is as expected for a highly variable (nuggetty) style deposit. It is SRK's view that a more smoothed grade profile will be realistic of the typical mineralization. More detailed sampling would be required to provide more accurate local estimates.

Minor grade discrepancies exist on a local scale in less densely sampled areas. The biggest differences in Yellow Rose occur within denser areas of channel sampling, with the channel sampling typically reporting high. SRK plots show the swath plots for ID2 and NN search ranges. The ID2 and NN estimates show a strong correlation, while the composite grade mean is sensitive to changes in the declustering patterns used at Yellow Rose.

Overall, SRK is confident that the interpolated grades reflect the available input sample data, and the estimate shows no sign of material bias, with the composite data typically showing more variability with higher skewed values.

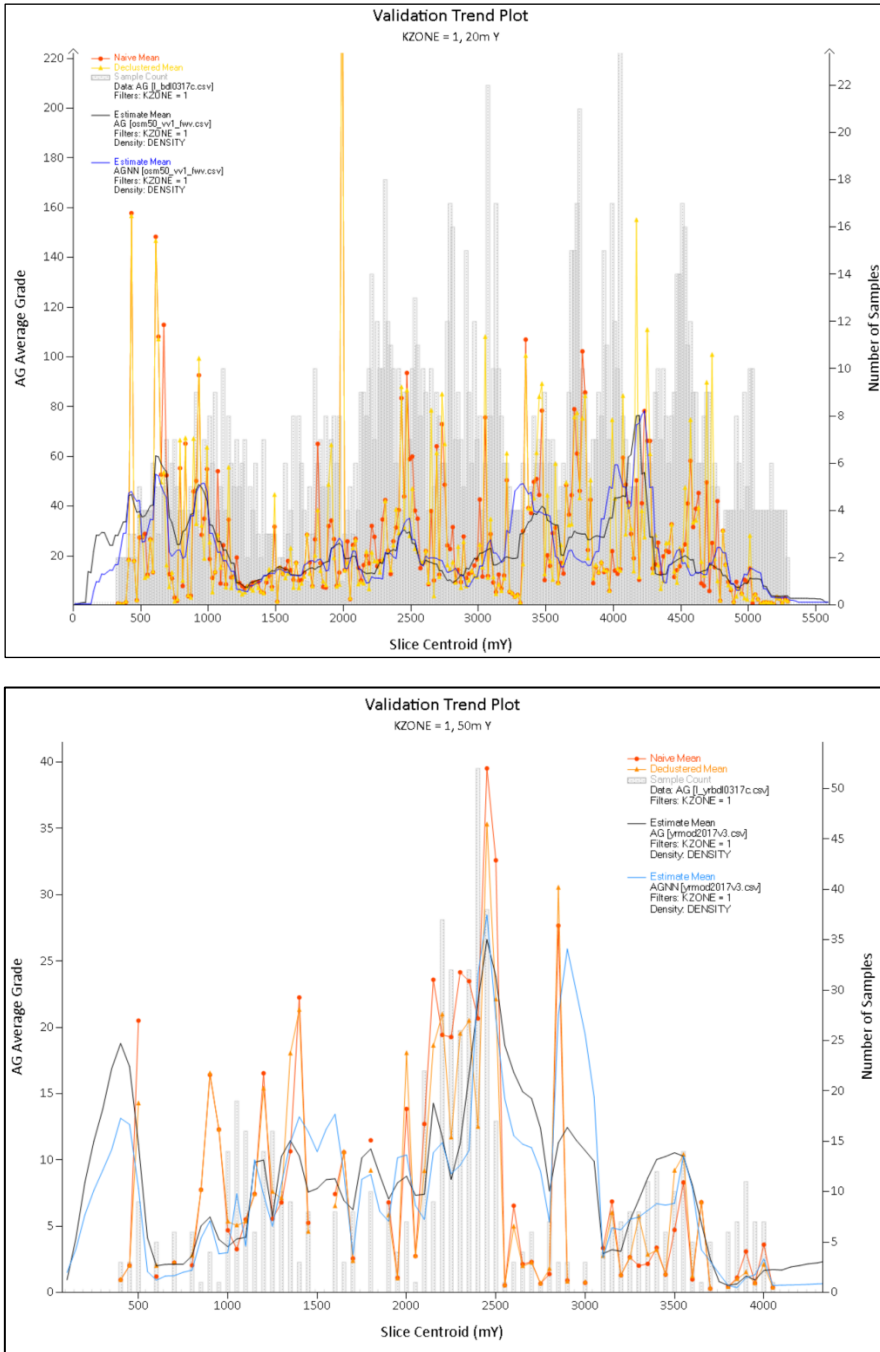

Source: SRK, 2017

Figure 14-8: Example of Swath Plots (Revenue and Yellow Rose) Used to Review Block Estimates versus Composites Along Strike of Each Vein

14.9 Resource Classification

Block model quantities and grade estimates for the Project were classified in accordance with the 2014 CIM Definition Standards.

Mineral Resource classification is typically a subjective concept. Industry best practices suggest that resource classification should consider both the confidence in the geological continuity of the mineralized structures, the quality and quantity of exploration data supporting the estimates and the geostatistical confidence in the tonnage and grade estimates.

Appropriate classification criteria should aim at integrating both concepts to delineate regular areas at similar resource classification.

Data quality, drillhole spacing and the interpreted continuity of grades controlled by the mineralization domains have allowed SRK to classify portions of the deposits in the Indicated and Inferred Mineral Resource categories.

The Resources at the Project are classified as Measured, Indicated and Inferred for the Virginius, Footwall, Terrible and Yellow Rose vein systems. The classification is based on standards as defined by the *CIM Definition Standards - For Mineral Resources and Mineral Reserves, prepared by the CIM Standing Committee on Reserve Definitions and adopted by CIM Council on May 10, 2014*.

Classification of the resources reflects the relative confidence of the grade estimates. The classification parameters are defined by the search radius, number of composites and number of drillholes in the estimation. The classification criteria are intended to encompass zones of reasonably continuous mineralization.

Mineral Resource estimates do not account for mineability, selectivity, mining loss and dilution. These Mineral Resource estimates include Inferred mineral resources that are normally considered too speculative geologically to have economic considerations applied to them that would enable them to be categorized as Mineral Reserves.

14.9.1 Virginius/Footwall and Terrible Classification

As no new sampling information in line with CIM best practices have been completed on within the current operation the classification remains unchanged.

Measured Mineral Resources at Virginius are those blocks having a minimum of three samples and three drillholes or channels, which are the majority of the estimates are within the first search passes (75 ft x 75 ft x 150 ft), along the Virginius Main Vein. This classification also takes into consideration that there has been underground development to expose the vein at depth and sampling of these workings over time. No Measured Mineral Resources have been defined for the Terrible Vein to date.

Indicated Mineral Resources at Virginius are those blocks having a minimum of three samples and three drillholes or channels, which are within an anisotropic search of approximately 150 ft x 150 ft x 300 ft ranges. SRK has run an initial pass for review (Figure 14-9) to establish these areas and then compared this to the potential mining areas, and given the mining method, produced broad stope shaped outlines where the majority of the polygon is supported with higher levels of confidence. This is to avoid isolated areas of Inferred which would prove problematic for mine planning purposes. When defining the edges of these limits some consideration of the NSR CoG have been considered.

Inferred Mineral Resources at Virginius are those blocks which are a maximum block-composite separation distance within an anisotropic search to the edge of the mineralization wireframe, which has been limited in Leapfrog to approximately 350 to 450 ft radius around the sampling on veins within the Virginius Vein.

A long section showing the classification for the Virginius Main Vein is shown in Figure 14-10, the Footwall Vein in Figure 14-11 and the Terrible Vein in Figure 14-12.

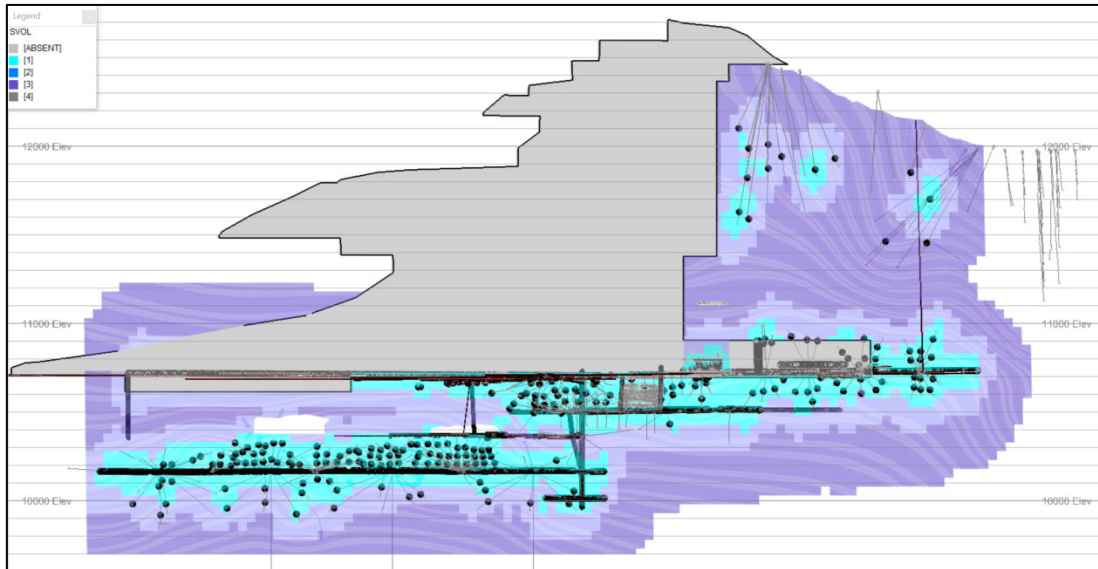

Source: SRK, 2017

Figure 14-9: Search Pass Estimated for Blocks of Virginius Vein (Long Section) Looking Southwest

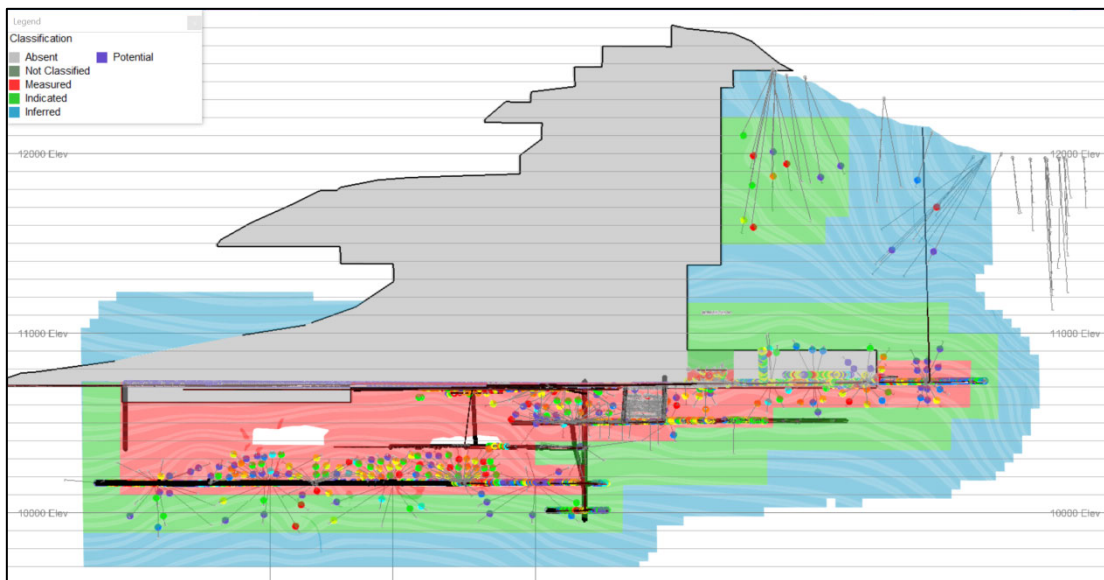

Source: SRK, 2017

Figure 14-10: Long Section (Looking Southwest) of Virginius Vein Showing Final Classification

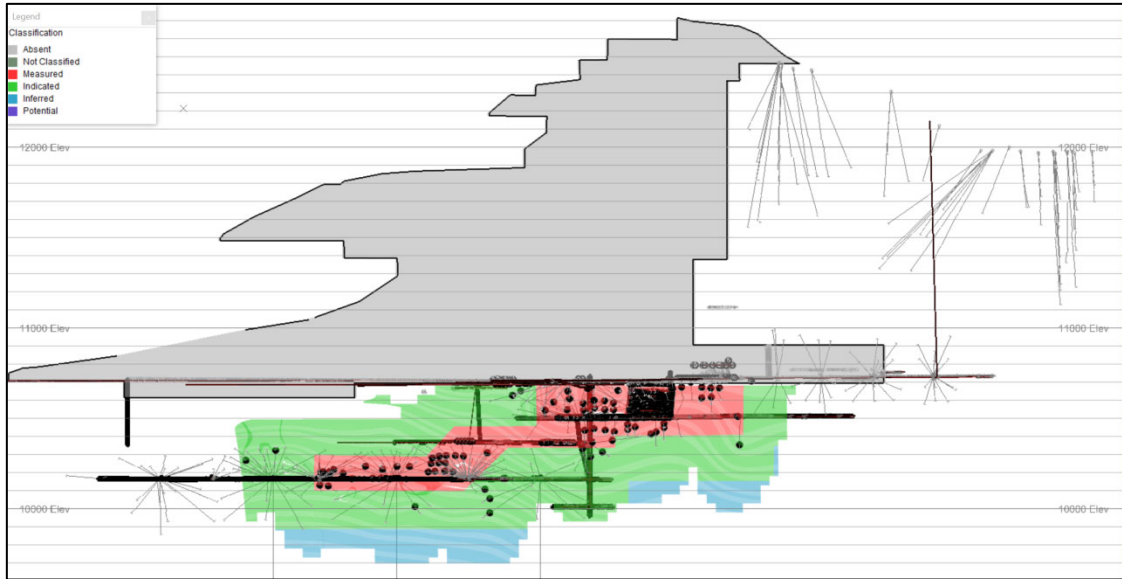

Source: SRK, 2017

Figure 14-11: Long Section (Looking Southwest) of Footwall Vein Showing Final Classification

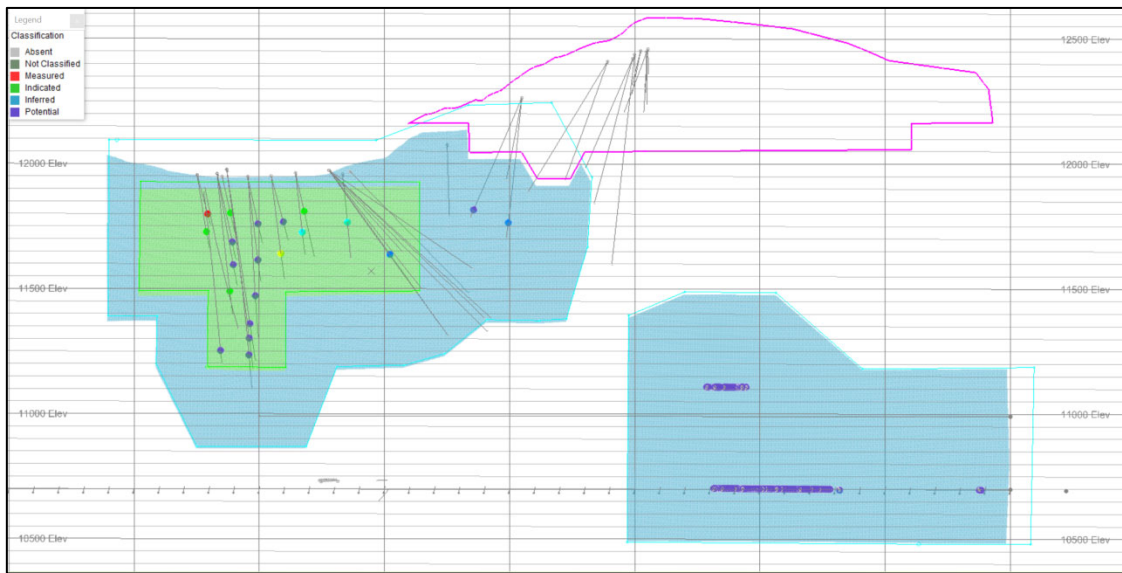

Source: SRK, 2017

Figure 14-12: Long Section (Looking Southwest) of Terrible Vein showing Final Classification

14.9.2 Yellow Rose Classification

No new sampling has been completed at the Yellow Rose and therefore the 2017 classification remains unchanged.

Measured Mineral Resources at Yellow Rose are those blocks having a minimum of three samples and three drillholes or channels, which are within an anisotropic search of 75 ft x 75 ft x 50 ft within the Yellow Rose Main vein and have potential for economic extraction. This classification takes into

consideration that there has been sampling in workings within the Yellow Rose Main Vein in addition to drilling.

Indicated Mineral Resources at Yellow Rose are those blocks having a minimum of three samples and three drillholes or channels, which are within an anisotropic search of approximately 125 ft x 125 ft x 50 ft within the Yellow Rose Main vein and have potential for economic extraction.

Inferred Mineral Resources at Yellow Rose are those blocks having a minimum of three samples and three drillholes, which are a maximum block-composite separation distance within an anisotropic search to the edge of the mineralization wireframe, which has been limited in Leapfrog to approximately a 250 ft radius around the sampling on the Yellow Rose Main Vein and in all other veins.

A long section showing the classification for the Yellow Rose Main Vein is shown in Figure 14-13.

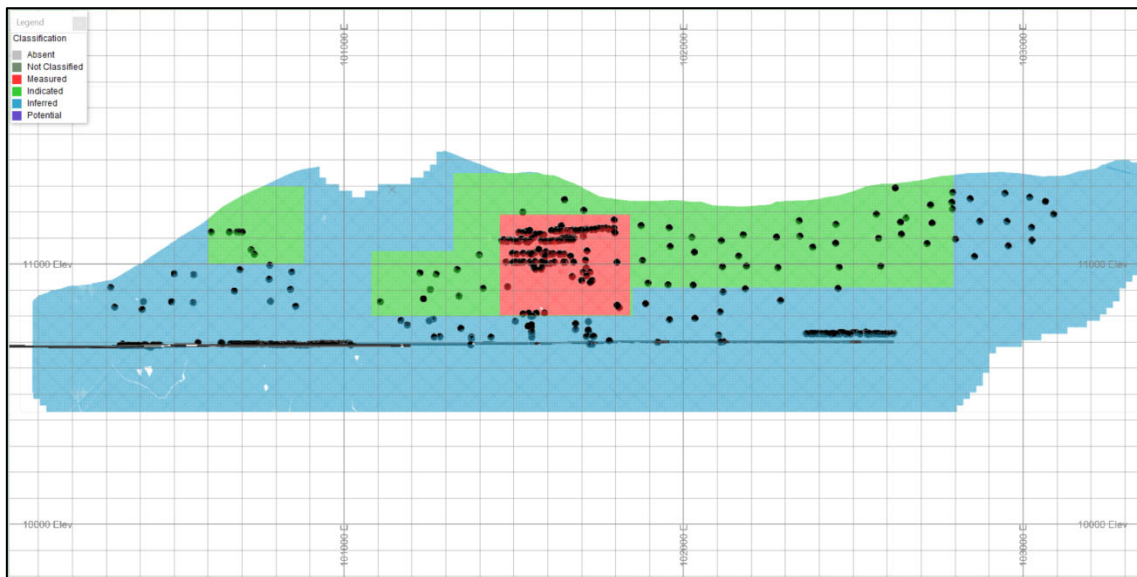

Source: SRK, 2017

Figure 14-13: Long Section (Looking Northeast) of Yellow Rose Vein Classification

14.10 Mineral Resource Statement

The following section defines the updated Mineral Resource Statement for the Project. This statement includes the estimated Mineral Resources for the deposit with an effective date of March 1, 2017, which is the date the final validated database was received. This represents the latest Mineral Resource estimate for the Project.

As shown in Section 28, CIM Definition Standards for Mineral Resources and Mineral Reserves (May 2014) defines a Mineral Resource as:

“A Mineral Resource is a concentration or occurrence of solid material of economic interest in or on the Earth’s crust in such form, grade or quality and quantity that there are reasonable prospects for eventual economic extraction. The location, quantity, grade or quality, continuity and other geological characteristics of a Mineral Resource are known, estimated or interpreted from specific geological evidence and knowledge, including sampling.”

Portions of a deposit that do not have reasonable prospects for eventual economic extraction must not be included in a Mineral Resource.

The “reasonable prospects for economic extraction” requirement generally imply that the quantity and grade estimates meet certain economic thresholds with a reasonable prospect for mining. To achieve this SRK has reported the Mineral Resources are reported at an appropriate CoG taking into account extraction scenarios and processing recoveries. Based on this requirement, SRK considers that major portions of the Project are amenable for underground extraction with a processing method to recover Ag, Au, Pb and Zn products, with possible Cu.

All results from channel samples and drilling at the Project that are within the wireframes were used in the Mineral Resource estimate. SRK has chosen to report the Mineral Resource for OSMI based on a NSR basis. NSR is a commonly accepted method of evaluating polymetallic mineralized material. NSR is defined as the proceeds from the sale of mineral products after deducting off-site processing and distribution costs. NSR is typically expressed on a dollar per ton basis.

For this Project, the NSR calculation takes into account revenue for four elements (Zn, Pb, Ag and Au) and production of two concentrates (lead concentrate and zinc concentrate). The NSR calculation for the resource and reserve is the same and is discussed in more detail in Section 15.2.3 of this report.

For the purpose of the NSR calculation, it was assumed that the Pb concentrate is 62.5% Pb and the Zn concentrate is 54% Zn. Copper is also present in the concentrates, however, is not payable at this time.

Plant recoveries for each concentrate are shown in Table 14-18 rounded to one decimal place and price assumptions in Table 14-19.

Table 14-18: Process Plant Recoveries by Concentrate Used in NSR Calculations for Geology

Conc.	Recoveries				
	Ag (%)	Au (%)	Cu (%)	Pb (%)	Zn (%)
Pb	93.4	63.3	88.8	93.8	20.0
Zn	1.0	4.9	2.0	1.0	74.0

Source: SRK, 2022

CoG price assumptions are listed in Table 14-19.

Table 14-19: NSR Calculation Commodity Price Assumptions

Commodity	Price	Units
Ag	\$23.75	US\$/oz
Au	\$1,765.00	US\$/oz
Pb	\$0.95	US\$/lb
Zn	\$1.15	US\$/lb

Source: SRK / OSMI 2022

SRK has accounted for the CoG during the classification of Measured and Indicated material, by working with OSMI staff on potential mining areas. Each area has then been evaluated to ensure that the defined areas remain above the NSR CoG, which is based on the NSR value. The Mineral Reserve NSR cut-off has been determined by SRK mining engineers and coded into the Mineral Resource model. The details of the NSR calculation are discussed in more detail in Section 15.2.3.

Once an area has been identified SRK analyzed the blocks based on the confidence criteria laid out in Section 14.9, and coding the model with the NSR value. The average thickness of the panel is considered in terms of limiting any potential mining areas.

In comparison for the Inferred Resources SRK does not consider there to be sufficient confidence in the estimates to define the edges of any potential stope areas. For the purpose of defining the potential for economic extractions, SRK assumed a NSR cut-off of US\$325/st, which is based on the proposed incremental mining, process and G&A costs detailed in and the prices and recoveries detailed in Table 14-18 and Table 14-19.

Table 14-20: Summary of Incremental Mining, Processing and G&A Costs

Operating Cost Category	Incremental CoG
	US\$/st Processed
Mine Operating Costs	117.97
Maintenance Costs	23.61
Plant Operating Costs	61.11
G&A	84.02
Surface Operating Costs	37.90
Total Operating Costs	\$323.61*

* Rounded to \$325 for reporting
 Source: SRK/OSMI, 2022

Table 14-21 shows the combined Mineral Resource for Yellow Rose and Virginius (Revenue) vein systems (inclusive of the Terrible Vein), with an effective date of December 31, 2021.

Table 14-21: OSMI Mineral Resource Estimate as of December 31, 2021 – SRK Consulting (U.S.), Inc.

RESCAT	Vein	Tons (kst)	Density (f/ft ³)	Au (oz/t)	Ag (oz/t)	Pb (%)	Zn (%)	Cu (%)	Au (koz)	Ag (koz)	Pb (klbs)	Zn (klbs)	Cu (klbs)
Measured	Virginius Vein	235	10.04	0.07	21.41	5.01	1.89	0.24	16	5,038	23,593	8,883	1,125
	Footwall	28	10.04	0.04	45.78	7.35	2.47	0.59	1	1,292	4,152	1,394	335
	Terrible	0	0.00	0	0	0	0	0	0	0	0	0	0
	Yellow Rose	43	10.04	0.06	22.14	4.51	2.53	0.17	2	942	3,842	2,154	148
<i>Measured</i>	<i>Subtotal</i>	<i>306</i>	<i>10.04</i>	<i>0.06</i>	<i>23.8</i>	<i>5.38</i>	<i>2.07</i>	<i>0.30</i>	<i>20</i>	<i>7,272</i>	<i>31,586</i>	<i>12,430</i>	<i>1,608</i>
Indicated	Virginius Vein	333	10.04	0.06	23.90	4.30	2.51	0.25	21	7,963	28,651	16,713	1,691
	Footwall	91	10.04	0.03	17.88	3.37	1.20	0.29	3	1,633	6,160	2,198	521
	Terrible	54	10.04	0.05	17.49	7.41	1.46	0.14	3	943	7,984	1,572	150
	Yellow Rose	229	10.04	0.03	11.80	2.44	1.69	0.10	8	2,696	11,153	7,725	439
<i>Indicated</i>	<i>Subtotal</i>	<i>707</i>	<i>10.04</i>	<i>0.05</i>	<i>18.7</i>	<i>3.81</i>	<i>1.98</i>	<i>0.20</i>	<i>34</i>	<i>13,234</i>	<i>53,947</i>	<i>28,208</i>	<i>2,801</i>
M&I	Virginius Vein	568	10.04	0.06	22.87	4.59	2.25	0.25	37	13,001	52,244	25,596	2,816
	Footwall	120	10.04	0.03	24.47	4.31	1.50	0.36	4	2,925	10,312	3,591	856
	Terrible	54	10.04	0.05	17.49	7.41	1.46	0.14	3	943	7,984	1,572	150
	Yellow Rose	271	10.04	0.04	13.42	2.77	1.82	0.11	10	3,638	14,994	9,879	587
<i>M&I</i>	<i>Subtotal</i>	<i>1,013</i>	<i>10.04</i>	<i>0.05</i>	<i>20.5</i>	<i>4.23</i>	<i>1.98</i>	<i>0.23</i>	<i>53</i>	<i>20,506</i>	<i>85,534</i>	<i>40,638</i>	<i>4,409</i>
Inferred*	Virginius Vein	164	10.04	0.08	35.8	6.63	3.12	0.34	12	5,864	21,694	10,224	1,116
	Footwall	6	10.04	0.05	30.2	3.66	1.18	0.38	0	172	416	135	43
	Terrible	55	10.04	0.12	29.4	7.07	1.31	0.11	7	1,625	7,815	1,448	124
	Yellow Rose	95	10.04	0.03	23.3	1.45	1.90	0.17	3	2,220	2,755	3,609	318
<i>Inferred</i>	<i>Subtotal</i>	<i>320</i>	<i>10.04</i>	<i>0.07</i>	<i>30.7</i>	<i>4.99</i>	<i>2.43</i>	<i>0.25</i>	<i>23</i>	<i>9,881</i>	<i>32,680</i>	<i>15,416</i>	<i>1,601</i>

- Mineral Resources are reported inclusive of the Mineral Reserves.
- Mineral Resources are not Mineral Reserves and do not have demonstrated economic viability. There is no certainty that all or any part of the Mineral Resources estimated will be converted into Mineral Reserves.
- Mineral Resource tonnage and contained metal have been rounded to reflect the accuracy of the estimate, and numbers may not add due to rounding.
- All Measured and Indicated estimates with the defined wireframes are considered to have potential for economic extraction as the entire level will be mined
- Inferred Mineral Resources are limited using a NSR cut-off US\$325/st.
- Metal price assumptions considered for the calculation of NSR are: Gold (US\$1,765/oz), Silver (US\$23.75/oz), Lead (US\$0.95/lb), and Zinc (US\$1.15/lb).
- Cut-off calculations assume average metallurgical recoveries equal to: Gold (68%), Silver (94%), Lead (95%), Copper (91%) and Zinc (94%).
- The resources were estimated by Benjamin Parsons, BSc, MSc Geology, MAusIMM (CP) #222568 of SRK, a Qualified Person

Source: SRK, 2022

14.11 Mineral Resource Sensitivity

SRK highlights that most of the sensitivity during mining is likely related to internal variations in grades at a stope level. The current model which has been defined assumes that all material within an Indicated or Measured block represents an in situ Mineral Resource. Only changes in the boundaries due to changes in economics can be defined as true sensitivity.

To provide some indication of the potential variation within the Measured and Indicated defined areas for the main veins, SRK has produced a grade tonnage sensitivity table which gives indicative estimates of the proportions of high- and low-grade mineralization within the category.

The results are shown in Table 14-22 through Table 14-25.

Table 14-22: Grade Tonnage Sensitivity Virginius Vein, Split by M&I and Inferred

Cut-off (NSR)	Tons (st)	Au (oz/st)	Ag (oz/st)	Pb (%)	Zn (%)	Cu (%)	Au (oz)	Ag (oz)	Pb (lbs)	Zn (lbs)	Cu (lbs)
0	568.5	0.06	22.87	4.59	2.25	0.25	36,800	13,001	52,244	25,596	2,816
25	549.5	0.07	23.65	4.75	2.33	0.26	36,700	12,995	52,162	25,579	2,813
50	545.5	0.07	23.81	4.78	2.34	0.26	36,700	12,990	52,115	25,564	2,811
75	518.8	0.07	24.96	4.99	2.43	0.27	36,200	12,948	51,803	25,175	2,795
100	494.1	0.07	26.09	5.2	2.5	0.28	35,600	12,893	51,429	24,739	2,769
125	486.1	0.07	26.48	5.26	2.54	0.28	35,400	12,871	51,188	24,681	2,759
150	472.4	0.07	27.14	5.38	2.59	0.29	34,900	12,820	50,836	24,484	2,729
175	457.8	0.08	27.85	5.5	2.64	0.29	34,300	12,752	50,336	24,187	2,696
200	438.7	0.08	28.83	5.65	2.69	0.3	33,600	12,648	49,599	23,636	2,661
225	413.5	0.08	30.18	5.87	2.77	0.31	32,600	12,481	48,541	22,905	2,594
250	397.4	0.08	31.11	6.01	2.83	0.32	31,900	12,361	47,777	22,472	2,548
275	380.3	0.08	32.15	6.17	2.89	0.33	30,900	12,227	46,900	21,985	2,494
300	363.8	0.08	33.23	6.31	2.95	0.34	29,900	12,087	45,917	21,437	2,445
325	346.8	0.08	34.42	6.48	2.99	0.35	28,600	11,935	44,958	20,739	2,395
350	325.0	0.08	36.01	6.66	3.04	0.36	27,400	11,704	43,267	19,763	2,316
375	302.8	0.09	37.73	6.88	3.1	0.37	26,200	11,424	41,674	18,747	2,234
400	302.8	0.09	37.73	6.88	3.1	0.37	26,200	11,424	41,674	18,747	2,234
Inferred											
Cut-off (NSR)	Tons (st)	Au (oz/st)	Ag (oz/st)	Pb (%)	Zn (%)	Cu (%)	Au (oz)	Ag (oz)	Pb (lbs)	Zn (lbs)	Cu (lbs)
0	449.0	0.05	15.95	3.12	1.97	0.5	21,400	7,163	28,065	17,656	4,482
25	430.7	0.05	16.62	3.25	2.05	0.52	21,300	7,159	27,982	17,640	4,480
50	407.1	0.05	17.55	3.42	2.15	0.55	21,000	7,143	27,847	17,506	4,467
75	389.7	0.05	18.26	3.54	2.21	0.57	20,700	7,115	27,591	17,241	4,420
100	340.1	0.06	20.56	3.93	2.39	0.63	19,900	6,991	26,713	16,252	4,269
125	309.2	0.06	22.25	4.23	2.53	0.63	19,300	6,879	26,164	15,654	3,888
150	293.3	0.06	23.21	4.41	2.59	0.63	19,000	6,808	25,887	15,206	3,672
175	276.0	0.07	24.34	4.62	2.65	0.63	18,500	6,719	25,478	14,606	3,503
200	261.9	0.07	25.34	4.8	2.7	0.63	18,000	6,637	25,136	14,168	3,281
225	244.9	0.07	26.61	5.03	2.77	0.59	17,400	6,517	24,661	13,564	2,883
250	228.6	0.07	27.99	5.29	2.85	0.55	16,400	6,400	24,192	13,015	2,535
275	189.9	0.08	32.02	6.12	2.97	0.33	14,300	6,081	23,257	11,296	1,237
300	175.9	0.07	34	6.4	3.12	0.33	13,000	5,981	22,529	10,990	1,143
325	163.6	0.08	35.83	6.63	3.12	0.34	12,400	5,864	21,694	10,224	1,116
350	150.9	0.08	37.84	6.92	3.21	0.36	12,000	5,709	20,885	9,689	1,076
375	137.7	0.08	40.09	7.31	3.33	0.38	11,500	5,522	20,149	9,179	1,033
400	137.7	0.08	40.09	7.31	3.33	0.38	11,500	5,522	20,149	9,179	1,033

Source: SRK, 2022

Table 14-23: Grade Tonnage Sensitivity Footwall Vein, Split by M&I and Inferred

Cut-off (NSR)	Tons (st)	Au (oz/st)	Ag (oz/st)	Pb (%)	Zn (%)	Cu (%)	Au (oz)	Ag (oz)	Pb (lbs)	Zn (lbs)	Cu (lbs)
0	119.6	0.03	24.47	4.31	1.5	0.36	3,800	2,925	10,312	3,591	856
25	119.6	0.03	24.47	4.31	1.5	0.36	3,800	2,925	10,312	3,591	856
50	114.2	0.03	25.55	4.49	1.56	0.37	3,700	2,917	10,258	3,558	851
75	108.8	0.03	26.71	4.67	1.61	0.39	3,700	2,906	10,153	3,513	845
100	101.7	0.04	28.36	4.92	1.7	0.41	3,600	2,885	10,005	3,453	835
125	93.6	0.04	30.55	5.19	1.79	0.43	3,400	2,859	9,724	3,347	813
150	85.1	0.04	33.15	5.56	1.91	0.47	3,200	2,821	9,468	3,243	794
175	79.7	0.04	35.03	5.79	1.98	0.49	3,100	2,793	9,230	3,154	782
200	78.3	0.04	35.54	5.86	2	0.5	3,100	2,785	9,175	3,131	777
225	72.9	0.04	37.66	6.14	2.09	0.52	2,900	2,744	8,955	3,053	754
250	69.0	0.04	39.24	6.37	2.17	0.54	2,800	2,708	8,799	2,997	740
275	65.7	0.04	40.76	6.55	2.23	0.55	2,700	2,678	8,603	2,934	723
300	64.0	0.04	41.56	6.65	2.26	0.56	2,700	2,660	8,515	2,896	713
325	61.2	0.04	42.93	6.8	2.31	0.57	2,600	2,628	8,324	2,825	701
350	58.8	0.04	44.16	6.96	2.36	0.59	2,500	2,595	8,177	2,771	693
375	57.2	0.04	44.97	7.05	2.39	0.6	2,500	2,574	8,066	2,732	688
400	54.2	0.04	46.67	7.23	2.43	0.62	2,400	2,527	7,830	2,634	670
Inferred											
Cut-off (NSR)	Tons (st)	Au (oz/st)	Ag (oz/st)	Pb (%)	Zn (%)	Cu (%)	Au (oz)	Ag (oz)	Pb (lbs)	Zn (lbs)	Cu (lbs)
0	79.3	0.02	4.98	1.25	0.93	0.1	1,800	394	1,988	1,478	161
25	68.5	0.03	5.73	1.42	1.07	0.11	1,800	392	1,951	1,465	157
50	59.8	0.03	6.47	1.54	1.18	0.12	1,700	387	1,842	1,405	149
75	52.2	0.03	7.19	1.66	1.26	0.13	1,600	376	1,736	1,312	137
100	43.8	0.03	8.12	1.81	1.36	0.14	1,400	356	1,587	1,189	125
125	27.4	0.04	11.33	2.44	0.91	0.19	1,000	310	1,336	496	102
150	23.0	0.04	12.64	2.54	0.97	0.19	900	291	1,170	445	85
175	20.6	0.04	13.58	2.63	0.92	0.19	800	279	1,083	380	79
200	18.2	0.04	14.65	2.74	0.98	0.2	700	266	997	355	72
225	8.1	0.05	24.28	3.12	1.03	0.33	400	196	502	165	53
250	7.1	0.05	26.38	3.28	1.07	0.35	300	188	468	153	50
275	6.8	0.05	27.26	3.39	1.09	0.35	300	185	459	148	48
300	6.4	0.04	28.2	3.47	1.12	0.36	300	182	447	144	47
325	5.7	0.05	30.24	3.66	1.18	0.38	300	172	416	135	43
350	5.2	0.04	32.06	3.78	1.22	0.4	200	166	391	126	41
375	5.2	0.04	32.06	3.78	1.22	0.4	200	166	391	126	41
400	4.6	0.05	33.88	3.98	1.25	0.43	200	157	370	116	40

Source: SRK, 2022

Table 14-24: Grade Tonnage Sensitivity Terrible Vein Split by M&I, and Inferred

Cut-off (NSR)	Tons (st)	Au (oz/st)	Ag (oz/st)	Pb (%)	Zn (%)	Cu (%)	Au (oz)	Ag (oz)	Pb (lbs)	Zn (lbs)	Cu (lbs)
0	53.9	0.05	17.49	7.41	1.46	0.14	2,900	943	7,984	1,572	150
25	53.7	0.05	17.22	7.41	1.46	0.14	2,900	924	7,955	1,567	146
50	53.7	0.05	17.22	7.41	1.46	0.14	2,900	924	7,955	1,567	146
75	51.7	0.06	17.83	7.67	1.49	0.14	2,900	921	7,922	1,537	145
100	47.3	0.06	19.3	8.3	1.57	0.15	2,700	912	7,847	1,483	144
125	44.7	0.06	20.26	8.71	1.62	0.16	2,600	905	7,788	1,448	143
150	42.9	0.06	20.95	8.97	1.65	0.17	2,600	899	7,700	1,414	142
175	42.6	0.06	21.08	9.02	1.65	0.17	2,600	897	7,679	1,407	142
200	42.4	0.06	21.15	9.05	1.66	0.17	2,600	896	7,662	1,402	142
225	41.3	0.06	21.51	9.18	1.66	0.17	2,600	890	7,590	1,374	141
250	41.0	0.06	21.64	9.21	1.66	0.17	2,500	887	7,550	1,363	141
275	39.8	0.06	22.05	9.34	1.68	0.18	2,500	878	7,437	1,341	140
300	39.5	0.06	22.14	9.37	1.69	0.18	2,500	876	7,407	1,334	140
325	38.3	0.06	22.55	9.46	1.68	0.18	2,500	864	7,252	1,290	138
350	37.1	0.07	22.96	9.55	1.68	0.18	2,400	852	7,091	1,247	136
375	36.2	0.07	23.22	9.63	1.67	0.19	2,400	842	6,980	1,210	135
400	35.6	0.07	23.43	9.67	1.67	0.19	2,400	833	6,880	1,187	134
Inferred											
Cut-off (NSR)	Tons (st)	Au (oz/st)	Ag (oz/st)	Pb (%)	Zn (%)	Cu (%)	Au (oz)	Ag (oz)	Pb (lbs)	Zn (lbs)	Cu (lbs)
0	268.0	0.07	7.22	1.79	0.39	0.03	19,400	1,934	9,611	2,066	139
25	268.0	0.07	7.22	1.79	0.39	0.03	19,400	1,934	9,611	2,066	139
50	248.4	0.08	7.75	1.93	0.42	0.03	18,700	1,926	9,579	2,065	139
75	235.8	0.08	8.13	2.02	0.44	0.03	18,100	1,916	9,526	2,059	139
100	139.8	0.09	12.93	3	0.57	0.05	12,700	1,807	8,385	1,599	130
125	80.5	0.11	21.15	5.11	0.96	0.08	8,600	1,703	8,228	1,538	128
150	60.0	0.11	27.66	6.85	1.28	0.11	6,900	1,659	8,217	1,534	127
175	60.0	0.11	27.66	6.85	1.28	0.11	6,900	1,659	8,217	1,534	127
200	59.3	0.12	27.94	6.9	1.29	0.11	6,800	1,655	8,178	1,524	127
225	58.4	0.12	28.25	6.95	1.29	0.11	6,800	1,650	8,119	1,509	126
250	57.5	0.12	28.58	7	1.3	0.11	6,800	1,644	8,051	1,495	126
275	56.8	0.12	28.86	7.03	1.3	0.11	6,700	1,639	7,982	1,481	125
300	56.4	0.12	28.99	7.04	1.31	0.11	6,700	1,636	7,941	1,473	125
325	55.3	0.12	29.38	7.07	1.31	0.11	6,700	1,625	7,815	1,448	124
350	54.5	0.12	29.65	7.08	1.31	0.11	6,600	1,617	7,719	1,428	123
375	54.0	0.12	29.83	7.08	1.31	0.11	6,600	1,612	7,657	1,415	123
400	53.3	0.12	30.08	7.08	1.31	0.11	6,600	1,603	7,542	1,394	122

Source: SRK, 2022

Table 14-25: Grade Tonnage Sensitivity Yellow Rose Vein Split by M&I, and Inferred

Cut-off (NSR)	Tons (st)	Au (oz/st)	Ag (oz/st)	Pb (%)	Zn (%)	Cu (%)	Au (oz)	Ag (oz)	Pb (lbs)	Zn (lbs)	Cu (lbs)
0	271.1	0.04	13.42	2.77	1.82	0.11	10,000	3,638	14,994	9,879	587
25	270.9	0.04	13.43	2.77	1.82	0.11	10,000	3,637	14,993	9,878	587
50	266.0	0.04	13.66	2.82	1.85	0.11	9,900	3,633	14,984	9,862	587
75	261.1	0.04	13.87	2.86	1.88	0.11	9,900	3,622	14,948	9,810	585
100	244.2	0.04	14.69	3.03	1.98	0.12	9,300	3,587	14,817	9,646	578
125	228.1	0.04	15.5	3.19	2.05	0.12	8,800	3,537	14,536	9,345	569
150	206.8	0.04	16.64	3.38	2.12	0.13	8,400	3,440	13,978	8,753	551
175	192.6	0.04	17.47	3.53	2.17	0.14	8,000	3,365	13,587	8,364	538
200	180.8	0.04	18.2	3.64	2.23	0.14	7,700	3,291	13,147	8,051	524
225	167.5	0.04	19.06	3.76	2.28	0.15	7,400	3,193	12,591	7,656	509
250	150.9	0.05	20.22	3.94	2.36	0.16	7,000	3,050	11,876	7,130	486
275	135.2	0.05	21.51	4.05	2.41	0.17	6,600	2,909	10,944	6,510	461
300	125.9	0.05	22.33	4.15	2.45	0.18	6,300	2,810	10,453	6,173	443
325	114.1	0.05	23.48	4.26	2.5	0.18	5,900	2,680	9,716	5,709	420
350	104.9	0.05	24.46	4.39	2.54	0.19	5,600	2,567	9,218	5,323	401
375	96.0	0.05	25.49	4.51	2.58	0.2	5,200	2,448	8,666	4,948	382
400	90.8	0.06	26.14	4.56	2.61	0.2	5,000	2,374	8,280	4,738	369
Inferred											
Cut-off (NSR)	Tons (st)	Au (oz/st)	Ag (oz/st)	Pb (%)	Zn (%)	Cu (%)	Au (oz)	Ag (oz)	Pb (lbs)	Zn (lbs)	Cu (lbs)
0	542.6	0.02	6.46	0.76	0.92	0.05	12,400	3,506	8,203	9,937	552
25	519.1	0.02	6.73	0.79	0.95	0.05	12,300	3,496	8,164	9,866	550
50	423.3	0.03	8.06	0.88	1.06	0.06	11,300	3,414	7,409	8,936	525
75	282.0	0.03	11.22	1.1	1.27	0.08	9,300	3,163	6,209	7,167	475
100	234.9	0.04	12.96	1.21	1.38	0.1	8,300	3,045	5,670	6,501	454
125	201.0	0.04	14.55	1.29	1.48	0.11	7,500	2,926	5,206	5,940	436
150	175.1	0.04	16.07	1.35	1.56	0.12	6,700	2,814	4,731	5,468	419
175	542.6	0.02	6.46	0.76	0.92	0.05	12,400	3,506	8,203	9,937	552
200	138.5	0.04	18.9	1.37	1.66	0.14	5,400	2,617	3,792	4,602	383
225	128.1	0.04	19.87	1.37	1.7	0.14	4,900	2,546	3,503	4,362	370
250	120.8	0.04	20.6	1.34	1.71	0.15	4,600	2,488	3,237	4,137	359
275	112.4	0.04	21.46	1.35	1.76	0.15	4,100	2,412	3,041	3,946	347
300	104.2	0.03	22.32	1.4	1.82	0.16	3,600	2,327	2,918	3,802	335
325	95.2	0.03	23.33	1.45	1.9	0.17	3,100	2,220	2,755	3,609	318
350	86.2	0.03	24.48	1.48	1.97	0.17	2,600	2,111	2,556	3,400	299
375	79.5	0.03	25.31	1.53	2.02	0.18	2,300	2,013	2,427	3,210	285
400	75.9	0.03	25.73	1.55	2.04	0.18	2,200	1,953	2,351	3,091	277

Source: SRK, 2022

14.12 Relevant Factors

SRK is not aware of any current environmental, permitting, legal, title, taxation marketing or other factors that could affect the Mineral Resource estimates.

SRK considers there to be potential to increase the current Mineral Resource via systematic exploration of known veins not currently estimated, which lie within the OSMI licenses. The following veins are controlled by OSMI but have not been systematically explored at this time. These veins include but are not limited to the Wheel of Fortune Vein, the Atlas-Cumberland system, and extension of the Terrible Vein.

SRK cautions the reader that all these targets are potential upside and that the potential quantity and grade is conceptual in nature, and there has been insufficient exploration to define a mineral resource and that it is uncertain if further exploration will result in the target being delineated as a mineral resource.

Terrible Vein System

The Terrible Vein system is a major vein system, which is in close proximity to the Virginius Vein in the north portion of the current mine, upon which an initial Mineral Resource has been defined. The geological interpretation from underground and surface traces indicates these veins likely cross (or merge) to the north of the current mining development, but due to the close proximity may represent the best short-term additional exploration target. The reinterpretation work completed by OSMI of the intersections near surface, align with the orientation of historical mining areas, and the Terrible drift (situated off the revenue tunnel level). The current known strike length of the Terrible Vein is estimated at over 3,500 ft.

Drilling from the footwall of the current Virginius Vein North of the Revenue Tunnel area may provide the best short-term drilling locations but given the dip and strike of the projected vein, the intersection angles will need to be reviewed.

Channel sampling has been completed on the Terrible Vein, both from the Terrible drift or from a test raise located along the drift. One interpretation is that the main mineralization is above the current mining level. Review of historical reports indicates that a test raise was established with limited sampling taking place on 3rd level, which at the time were stopped due to water issues, not due to low grades. There remains potential open ground between the historical workings at surface some 850 ft above the top of the raise and last sampling. A historical report dating back to 1928, suggests the known depth from surface is in the order of 2,150 ft.

Additional drilling will be required to prove up the potential of the Terrible Vein, and there is no guarantee that additional drilling will result in Mineral Resources or Mineral Reserves.

Cumberland Vein System

The Cumberland-Atlas Vein system is a major vein system that is sub-parallel to the Virginius and located about midway between the Virginius and the Revenue Portal, west of Yellow Rose Vein. The old Atlas crosscut tunnel, with a portal elevation of 11,225 ft, was the daylight point for production by old-timers on the Atlas claim. The Atlas tunnel provided production access prior to 1893. Mined material was transported downhill to the north by means of an aerial tram and treated at the Atlas mill. After 1893, when the Atlas Vein was exposed along the Revenue Tunnel, smaller scale exploration and mining were conducted on the northern extension of the Atlas Vein, along the Cumberland Vein.

Historical reports indicate that the original working on the Cumberland Vein were done between 1911 and 1919. Further workings occurred during the 1940's when sampling was completed on the 200 Level (above the Revenue Level). During the 1960's reports indicate that the exploration drift was extended out the 200lvl (above the Revenue Level), as well as a shaft to 200' ft, followed by minor drifting on 2 levels below the revenue level. No detailed survey and capture of this data are included in the current database, and further work to validate the location of these workings will be required.

Available historical sample maps and reports mention documented efforts to explore and work the vein system but a systematic report of the history of the Revenue Tunnel mining has not been found. The Cumberland Vein strikes N48-55°W, similar to the Virginius but in contrast with the Virginius Vein, dips steeply to the NE. A historical report dating back to 1928, suggests the known strike length is 4,200 ft, with a depth extension in the order of 1,400 ft.

Wheel of Fortune Vein System

The Wheel of Fortune Mine was located in 1877 and has been a very rich producer. Historic records for the Pueblo Smelter in 1882 show an average Wheel of Fortune ore grade at 7.96 oz/st Au, and 176.46 oz/st for Ag for an unspecified tonnage. The vein occupies a strong persistent fissure that follows an andesitic dike that strikes northeast and dips some 65 to 75° northwest. The vein is located in Silver Basin and runs almost parallel to the Revenue Tunnel. The vein then crosses Sneffels Creek and continues up the flank of Potosi Peak and joins the Bimetallist Vein.

The Wheel of Fortune Vein has a strike direction approximately perpendicular to the general northwest-trending veins of the Sneffels District. It is reported that the potential strike length is over 7,400 ft. Despite its long extent there has been little production from the vein.

In the Wheel of Fortune, most of the work was done in the 1880's, and the main ore shoot was comparatively shallow and followed down the contour of the mountain and on its rake would extend below Sneffels Creek. During the early days of the Wheel of Fortune mine, the high-grade ore was mined below the 11,000 level and was irregular.

Though the structure is strong and persistent, at the Revenue Tunnel Level it appears that this may be too deep to host economic material of significant width. The Wheel of Fortune structure may contain mineralized shoots at higher elevations along its strike length, and it represents an important target. A surface mapping and sampling program, following the surface trace of the vein, is warranted, to explore for anomalous segments, which could be subsequently drilled. The Wheel of Fortune Vein intersects Yellow Rose drift, so exploration development access is relatively easy.

Historical reports by OMSI indicate the extents of drifting from the Yellow Rose Vein intersection with the Wheel of Fortune Vein both directions suffered poor ground conditions and cave ins not too far in, so remain under explored. OMSI have located reports of sampling from both underground at the Anglo Saxon crosscut and surface at random points along vein strike, but this is not stored in the current database and will require further validation.

Torpedo Vein System

The Torpedo Mine is located north of and just across the valley from the Revenue portal. The mine explores a consistent northwest trending quartz fluorite vein that dips at 60° to 80° to the SW. From the mine portal to the first major two-compartment raise is a distance of approximately 680 ft, which includes the initial 80 ft of crosscut to reach the vein near the portal. Except for a few points along the 600 ft of exposed vein, there has been no significant stoping of the vein. The drift is timbered at several places for support. Locally, there is abundant clay in the wall rock and sticky clay seams are common within and marginal to the vein. Beyond the caved raise at 680 ft, the main drift continues for another 450 ft to a second caved raise where waist-deep water backed up. No stopes exist along the 450 ft of exposed vein between the two caved raises.

The Torpedo Vein consists dominantly of banded epithermal quartz but is unusual for its abundant green to white fluorite and low sulfide content. Base metal sulfides were not observed in the vein and pyrite makes up a small percentage (1% to 3%) of the vein material. The vein ranges from 1 to +10 ft wide, averaging approximately 3 to 4 ft in width, and contains about 10% to 20% late-phase fluorite. Vein walls are moderately clay altered pyrite-bearing San Juan Formation but locally the walls consist of aphanitic mafic dike material that is also pyritic, and clay altered. These vein-parallel dikes are not obvious on the surface but are persistent underground.

A limited number of samples collected across the Torpedo Vein during an assessment of the underground workings, one returned a result of 0.455 oz/st Au over a width of 4.4 ft. SRK has not reviewed or confirmed these results. This was the back-most sample taken in the main drift, across a short crosscut exposing the main vein. For the length of the vein exposed in the accessible underground workings, the vein is dominantly quartz and fluorite with some carbonate. Sulfide minerals are virtually absent. The Torpedo Vein is currently an exploration target for the Company.

15 Mineral Reserve Estimate

15.1 Introduction

The Mineral Reserves are reported from three of the many known veins within the Project - the Virginius, Terrible and Yellow Rose Veins. All are quartz veins containing silver, gold, copper, lead and zinc minerals hosted primarily in the San Juan volcanic rocks. Veins range from several inches up to several feet, and have been mined and drilled over a vertical extent of over 3,000 ft. The veins typically have dips around 70° but vary locally from approximately 50° to 85°.

The property has been historically mined since the late 1800's. A 300 st/d underground mill was constructed around 2013 and commissioned in 2014, upgrades were completed in the period between 2018 and 2021 though commercial production has not yet occurred. Figure 15-1 shows the general site layout and location of the Mineral Reserve areas (Virginius, Yellow Rose, and Terrible areas).

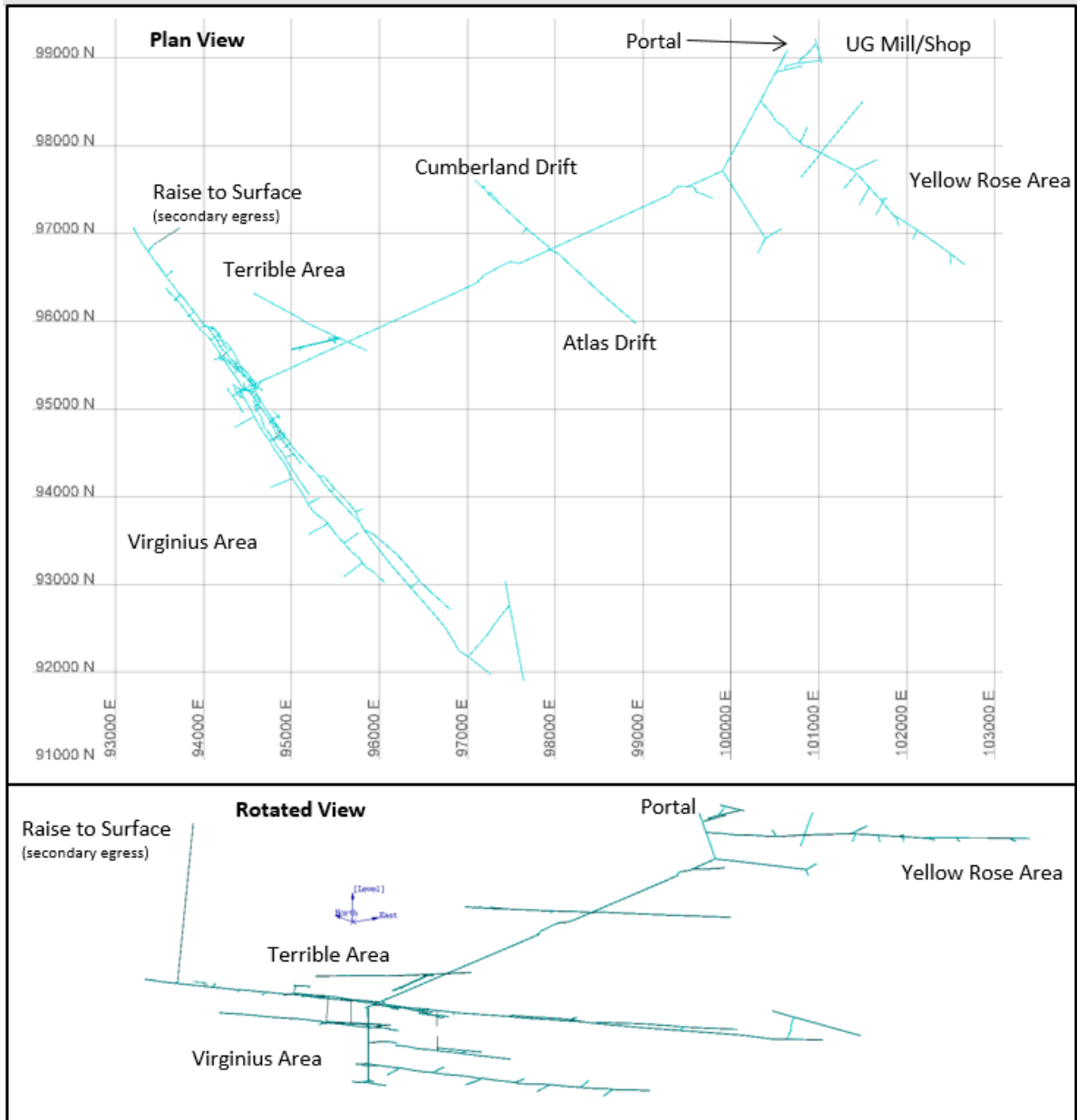

Source: SRK

Figure 15-1: OSMI Site Layout and Vein Location

15.2 Conversion Assumptions, Parameters and Methods

Measured and Indicated Mineral Resources were converted to Proven and Probable Mineral Reserves by applying the appropriate modifying factors, as described herein, to potential mining block shapes created during the mine design process.

Based on the orientation and width of the mineralization, review of historic mining and available geotechnical information, a resue mining method is appropriate where waste rock serves as backfill as the stope is advanced in an overhand manner. This method is highly selective and allows for mining narrow widths. A minimum mining width of 6 inches is used. The design assumes mining of large

panels where raises/infrastructure is used for the entire panel length. There may be places along the panel which fall below CoG; however, these must be mined due to the mining method and infrastructure. These lower grade areas are included in the reserve.

All mineral reserve tonnages are expressed as "dry" short tons (i.e., no moisture) and are based on the density values stored in the block model. Inferred material is not included in the mine plan. Mining dilution has been applied using the methodology described in Section 15.2.2 with a grade of zero.

A 3D mine design has been created representing the reserve areas. Dilution is included in the reserve and a 100% mining recovery of the planned mining areas is assumed as discussed in the following sections.

15.2.1 Mining Recovery

Sill pillars have been included in the mine design and are assumed to be left in-situ. 100% extraction of the planned mining panels is assumed. To achieve this, OSMI has committed - due to the high-grade nature of the ore - to use muck sheets, a material placed on top of the waste rock to segregate the ore from waste such as used conveyor belt, and a very selective mining method to maximize the recovery of the narrow vein ore. The miners will use handheld hoes and shovels to maximize recovery.

15.2.2 Dilution

Stope dilution estimates are based on the results of mining during a test stope executed by OSMI in April 2016, as explained in the following section. From the results of the April 2016 test stope, a best fit line was created to express the stope dilution based on vein width. The equation is as follows:

$$\text{Dilution} = -0.127 * \ln(\text{vein width}) + 0.1997$$

This formula results in a dilution range of 6.4% to 26.6% for the mining rescue stope panels. Dilution is applied at a zero grade for all metals.

Rescue Test Stope – April 2016

OSMI developed a rescue test stope in the Virginus North area above the 2000 level in April 2016. The stope was named the 561 stope. The test stope was intended to prove out assumptions on rescue mining and provide support for productivity assumptions, dilution, and general ability to minimize the dilution and maintain the narrow mining width.

Figure 15-2 shows the April 2016 test stope design as planned by OSMI. Figure 15-3 shows the actual location of the test stope above the 2000 level near ventilation raise to surface.

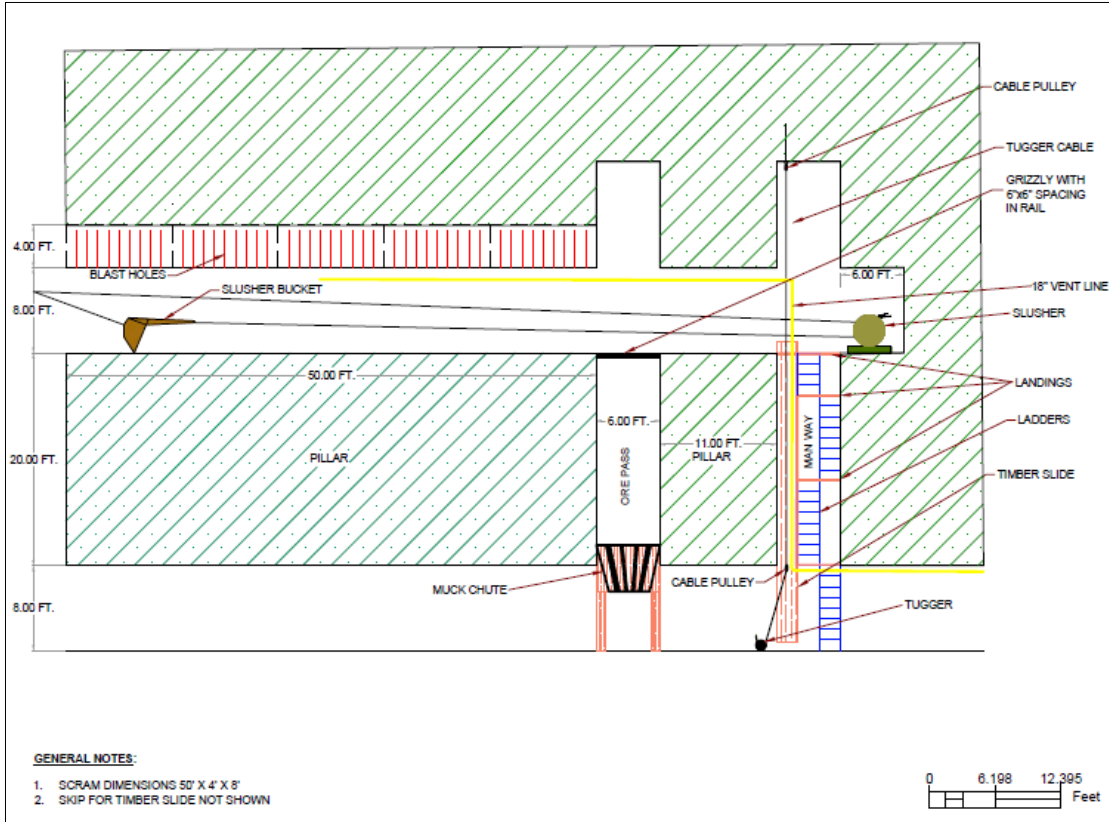

Source: OSMI 2016

Figure 15-2: Resue Mining Test Stope Layout

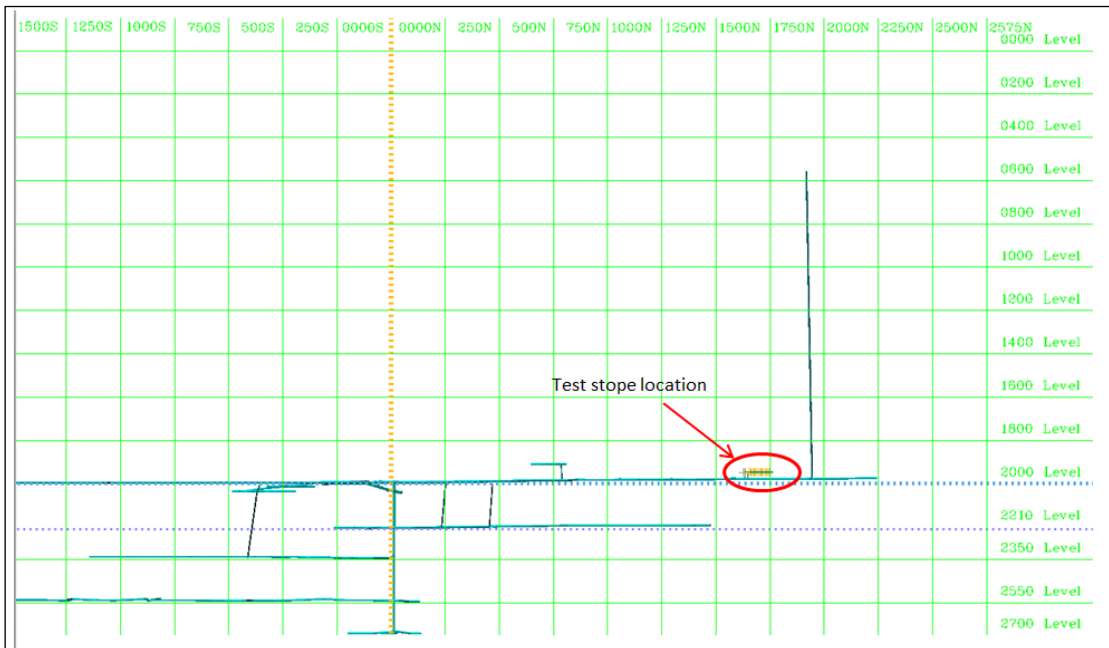

Source: SRK, 2017

Figure 15-3: Stope Location

The 561 Test Stope began April 13, 2016 and was conducted using a single crew of two miners. An access raise and manway were excavated as well as an ore pass with a manually operated chute. Utilities and a slusher, a mechanical bucket pulled with an electrical or air powered winch, were installed. The development of the stope took approximately six days with one crew working on day shift only. The scam, a narrow access drift along the bottom of the vein, was started on April 19, 2016, and driven a total of 86 ft. The scam was planned to be 4 ft wide and final survey indicated the average width was 3.5 ft.

After the scam was completed, several rescue rounds in mineralized material were taken starting at the back end of the stope moving back toward the manway. The vein material ranged in width from approximately 12 to 18 inches. The rescue ore shots maintained an average planned width in the top 2 to 2.5 ft of the 4.5 ft holes with an over-break in the bottom 2 ft of the hole of approximately 2 ft. Figure 15-4 shows a photograph of typical rescue slot.

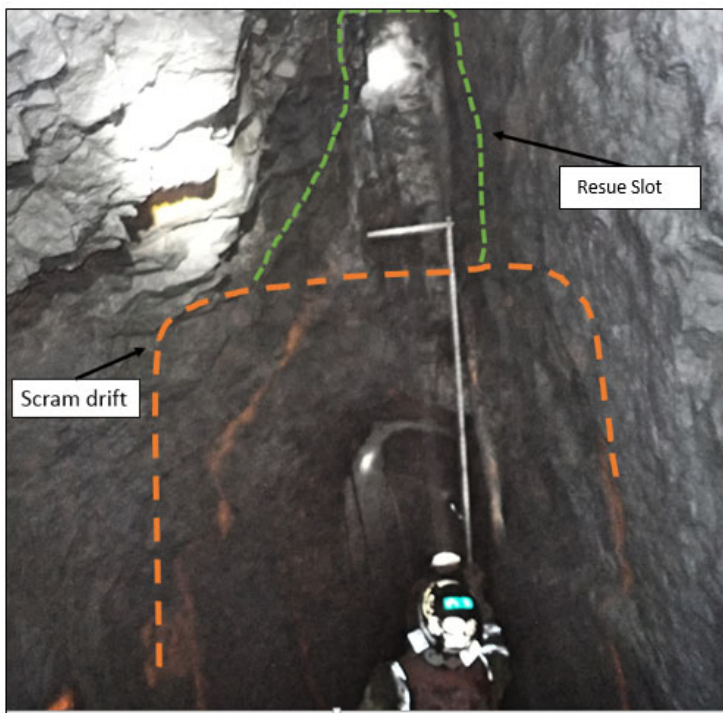

Source: OSMI 2016

Figure 15-4: Rescue Test Stope Photo

Table 15-1 summarizes the stations, vein widths and actual dilution for the April 2016 Test Stope.

Table 15-1: April 2016 Test Stope Results

Station	Vein Width (ft)	Ore Cut (ft ³)	Waste Cut (ft ³)	Dilution (%)
95	1.25	7.04	1.6	18.5%
100	1.08	6.11	0.42	6.4%
105	1.3	7.31	1.78	19.6%
110	1	5.66	1.86	24.7%
115	1	5.66	1.76	23.7%
120	1.5	11.58	1.97	14.5%

Source: OSMI 2016

A best fit line was created from this data and the equation specified at the beginning of Section 15.2.2 was used to estimate dilution for future stopes.

An additional test stope was executed in May 2017 as described in Section 16.3.3 and indicating this dilution equation reasonably represents the stope dilution.

Production Stopes

During the pre-production period up to December 2021, OSMI operating on the 1800 level and develop two stopes. Significant experience was developed on the mining method, costs, and productivities. This actual information has been incorporated into the updated mine plan and include:

- Reduced productivities as compared to 2018 FS based on actual operations.
- Recognition of impacts of access to the levels
- Recognition of the need for more headings to balance production
- Confirmation of labor rates – the rates needed to be higher than originally estimated to retain properly skilled miners
- Covid Impacts and mitigations
- Logistics required to transport employees to and from the mine effectively

15.2.3 Net Smelter Return

NSR is a commonly accepted method of evaluating polymetallic mineralized material. NSR is defined as the proceeds from the sale of mineral products after deducting off-site processing and distribution costs. NSR is typically expressed on a dollar per ton basis. For this Project, the NSR calculation takes into account revenue for four elements (Zn, Pb, Ag and Au) and production of two concentrates (lead concentrate and zinc concentrate). For the purpose of NSR calculation, it was assumed that the Pb concentrate is 62.5% Pb and the Zn concentrate is 54% Zn. Copper is also present in the concentrates, however, is not payable at this time.

Plant recoveries for each concentrate are shown in Table 15-2.

Table 15-2: Process Plant Recoveries by Concentrate

Conc.	Recoveries				
	Ag (%)	Au (%)	Cu (%)	Pb (%)	Zn (%)
Pb	93.44	63.26	88.76	93.78	19.97
Zn	1.0	4.92	2.0	1.0	73.95

Source: OSMI, 2022

Mineral payability, treatment/refining charges and freight were provided by OSMI and are summarized as follows:

Pb Concentrate

- Pb is 95% payable, subject to a three-unit minimum deduction
- Ag is 95% payable, subject to a minimum deduction of 1.46 oz/st (50 g/mt) and a US\$1.50 refining charge per payable ounce
- Au is 95% payable, subject to a minimum deduction of 0.03 oz/st (1 g/mt) and a US\$15.00 refining charge per payable ounce
- Treatment charges of US\$87.09/st (US\$96/mt)
- Freight charge of US\$188.70/wet short ton (wst) (US\$208/wmt) assuming shipping product at a 10% moisture content

- Arsenic (As) penalty of US\$1.36/st (US\$1.50/mt) per each 0.10% increment over 0.2%. Sb content is not modeled, assume a constant 0.80%
- Copper and zinc are not payable in the Pb concentrate in the block model NSR calculation

Zn Concentrate

- Zn is 85% payable, with a minimum eight-unit deduction
- Treatment charges of US\$87.09/st (US\$96/mt)
- Freight charge of US\$188.70/wst (US\$208/wmt) assuming shipping product at a 10% moisture content
- Ag, Au, Cu, and Pb are not payable in the Zn concentrate

Note that concentrate grade, recovery and market terms (e.g., payability) assumption used for CoG calculations may vary somewhat from final assumptions in the economic model, as these CoG assumptions were made prior to the results of the metallurgical and concentrate marketing studies. These changes in the economic model assumptions are not considered material to the mine design process.

Price assumptions used for the NSR calculation are shown in Table 15-3.

Table 15-3: NSR Calculation Commodity Price Assumptions

Commodity	Price	Units
Ag	\$23.75	US\$/oz
Au	\$1,765.00	US\$/oz
Pb	\$0.95	US\$/lb
Zn	\$1.15	US\$/lb

Source: OSMI, 2022

The basis for the mine design work is the resource block model as described in Section 14.

Table 15-4 shows an example NSR calculation for a single block.

Table 15-4: Example NSR Calculation

Input Block (from block model)				Tons (st)	Ag (oz/st)	Au (oz/st)	Cu (%)	Pb (%)	Zn (%)			
				500.0	32.20	0.06	0.20	5.00	2.00			
Contained Metal					(oz) 16,100.00	(oz) 30.00	(st) 1.00	(st) 25.00	(st) 10.00			
Prices					(US\$/oz) \$23.75	(US\$/oz) \$1,765	(US\$/lb) \$0.98	(US\$/lb) \$0.95	(US\$/lb) \$1.15			
Pb Cu Conc.												
	Recoveries (%)					93.44%	63.26%	88.76% % not Payable	93.78%	19.97%		
						Consolidated Basis				not Payable		
						US\$/st Conc.	Total US\$	(oz)	(oz)	(st)	(st)	(st)
62.5%	Contained Metal in Pb Conc. Grade of Pb Conc. Pb Conc. Generated	(oz/st for Ag & Au) (st)						15,043.84 401	18.98 0.5	0.89 2.4%	23.45 62.5%	2.00 5.3%
95%	Payability Lead	(st)									37.51	
3.00	Payable Metal Based on Payability Subject to Minimum Deduction: Minimum Deduction Units	(st)									22.27	
	Payable Conc. Grade After Deduction	(st)									3.00	
	Payable Metal based on Minimum Deduction	(st)									59.5%	
	Use Minimum Deduction										22.32	
											No	
	Payable Lead	(st) (US\$)				\$1,128.13	\$42,318.23				0.09	171.48
95%	Silver	(oz)						14,291.65				
50.00	Payable Metal Based on Payability Subject to Minimum Deduction: Minimum Deduction of 50 g/mt	(oz)						54.70				
	Payable Metal based on Minimum Deduction	(oz)						14,989.14				
	Use Minimum Deduction							No				
	Payable Silver	(oz) (US\$)				\$9,048.48	\$339,426.64	14,291.65 339,426.64				
95%	Gold	(oz)							18.03			
1.00	Payable Metal Based on Payability Subject to Minimum Deduction: Minimum Deduction of 1 g/mt	(oz)							1.09			
	Payable Metal based on Minimum Deduction	(oz)							17.88			
	Use Minimum Deduction								Yes			
	Payable Gold	(oz) (US\$)				\$841.47	\$31,565.16		17.88			
96	T/C (\$96/mt)	(US\$)				\$(87.09)	\$(3,266.94)					
1.50	Ag Refining Charge per Payable oz - \$1.50/oz	(US\$)				\$(571.48)	\$(21,437.47)	(\$21,437.47)				
15.00	Au Refining Charge per Payable oz - \$15.00/oz	(US\$)				\$(7.15)	\$(268.26)		(\$268.26)			
1.50	As Penalty	(US\$)				\$(8.16)	\$(306.28)					
0.20%	\$1.50/mt per each 0.10% increment over 0.20%											
0.10%	Assume As content of 0.80%											
0.80%	Moisture Content	10%										
	Total Tons of Conc. to Ship	(wst)									41.67	
208	Freight (\$208/wmt) apply to wet tons	(US\$)				\$(209.66)	\$(7,864.86)					
	Total Revenue Pb concentrate	(US\$)				\$10,134.52	\$380,166.21					
Zn Conc.												
	Recoveries (%)					1.00%	4.92%	2.00%	1.00%	73.95%		
						Consolidated Basis		Not Payable				
						US\$/St Conc.	Total	(oz)	(oz)	(st)	(st)	(st)
54.0%	Contained Metal in Zn Conc. Grade of Zn Conc. Zn Conc. Generated	(oz/st for Ag & Au) st						161.00 11.76	1.48 0.11	0.02 0.15%	0.25 1.83%	7.40 54.00%
85%	Payability Zinc	st									13.69	
8.00	Payable Metal Based on Payability Subject to Minimum Deduction: Minimum Deduction Units	st										6.29
	Payable Conc. Grade After Deduction	st										8.00
	Payable Metal based on Minimum Deduction	st										46.0%
	Use Minimum Deduction											6.30
												No
	Payable Zinc	st \$				\$1,055.70	\$14,457.23					6.29
0.00	Silver	oz						-				
0%	Straight Deduction of 0 g/mt	oz						161.00				
	Payable Metal after Deduction	oz						-				
	Payable Metal after Deduction & Payability	oz						-				
	Payable Silver	oz (US\$)				\$0	\$0	\$0				
-	Gold	oz							-			
0%	Straight Deduction of 0.0 g/mt	oz							1.48			
	Payable Metal after Deduction	oz							-			
	Payable Metal after Deduction & Payability	oz							-			
	Payable Gold	oz (US\$)				\$0	\$0	\$0				
96	T/C (\$96/mt)	(US\$)				\$(87.09)	\$(1,192.66)					
-	Ag Refining Charge per Payable oz - \$0.00/oz	(US\$)				\$-	\$-	-				

-	Au Refining Charge per Payable oz - \$0.00/oz	(US\$)	\$-	\$-	-			
3.00	As Penalty	(US\$)	\$(5.85)	\$(80.13)				
0.30%	\$3.00/dmt per each 0.10% increment over 0.30%							
0.10%	Assume As content of 0.52%							
0.52%	Moisture Content	10%						
208	Total Tons of Conc. to Ship	wst					15.22	
	Freight (US\$208/wmt) apply to wet tons	(US\$)	\$(209.66)	\$(2,871.21)				
	Total Revenue Zn concentrate	(US\$)	\$753.10	\$10,313.22				
	Total Net Smelter Return	(US\$)/st		\$390,479.43 780.96				

Source: SRK, 2022

15.2.4 Cut-off Evaluation

Current estimated project costs and the calculated NSR cutoff is shown in Table 15-5. NSR was calculated for each block in the resource model. For mine design the operating cutoff grade of \$391.73/t was used, with adjacent lower grade stopes down to the incremental CoG included in the design/reserves. Note that the operating cost does not include pre-production development to the stope, however, does include all development once in production including development within a stope (finger raises, manways, etc.)

Table 15-5: Estimated Total Operating Cost

Operating Cost Category	Operating CoG	Incremental CoG
	US\$/st Processed	US\$/st Processed
Mine Operating Costs	186.08	117.97
Maintenance Costs	23.61	23.61
Plant Operating Costs	60.11	61.11
G&A	84.02	84.02
Surface Operating Costs	37.90	37.90
Total Operating Costs	\$391.73	\$323.61

Source: SRK/OSMI

15.3 Reserve Estimate

Mineral reserves were classified using the 2014 CIM Definition Standards. The mineral reserve statement for OSMI is presented in Table 15-6. The mineral reserve estimate is effective as of December 31, 2021.

Table 15-6: OSMI Mineral Reserves Estimate as of December 31, 2021 – SRK Consulting (U.S.), Inc.

Area	Description	Tons (kst)	Ag (oz/st)	Au (oz/st)	Pb (%)	Zn (%)	Contained Ag (koz)	Contained Au (koz)	Contained Pb (klb)	Contained Zn (klb)	NSR (US\$/st)
Virginius	Proven	206.5	25.34	0.07	5.36	1.84	5,234	13.5	22,129	7,591	653
	Probable	226.0	28.84	0.06	4.80	2.50	6,518	13.8	21,678	11,319	713
	P+P	432.6	27.17	0.06	5.06	2.19	11,752	27.3	43,807	18,910	684
Terrible	Proven	0	0	0	0	0	-	-	-	-	0
	Probable	35.4	19.06	0.05	6.88	1.38	674	1.7	4,862	975	522
	P+P	35.4	19.06	0.05	6.88	1.38	674	1.7	4,862	975	522
Yellow Rose	Proven	44.1	20.48	0.05	4.26	2.34	904	2.3	3,762	2,068	834
	Probable	65.0	20.25	0.04	3.40	2.04	1,316	2.6	4,413	2,647	301
	P+P	109.1	20.34	0.05	3.75	2.16	2,220	4.9	8,174	4,714	517
All Areas Total	Proven	250.7	24.48	0.06	5.16	1.93	6,137	15.8	25,890	9,659	685
	Probable	326.4	26.07	0.06	4.74	2.29	8,508	18.1	30,953	14,941	610
	P+P	577.0	25.38	0.06	4.93	2.13	14,646	33.9	56,843	24,600	643

Source: SRK

- Reserves are inclusive of Mineral Resources. All figures are rounded to reflect the relative accuracy of the estimates. Totals may not sum due to rounding. NSR listed here may be somewhat different than values calculated in the final economic model due to updated information at time of economic modeling.
- Mineral reserves are reported using a NSR CoG of \$391.73/st. The reserve estimate is based on a mine design using this cutoff with adjacent lower grade incremental stopes included in the design. Incremental material is included in the reserves based on an incremental stope cutoff grade of \$323.61/st.
- Metal price assumptions considered for the calculation of NSR are: Gold (US\$1,765/oz), Silver (US\$23.75/oz), Lead (US\$0.95/lb), and Zinc (US\$1.15/lb).
- Metallurgical recoveries for payable items in the Pb concentrate are: Gold (63.26%), Silver (93.44%), and Lead (93.78%). Metallurgical recoveries for payable items in the Zn concentrate are: Zinc (73.95%).
- Mineral reserves have been stated on the basis of a mine design, mine plan, and cash-flow model. Full mining recovery of designed areas is assumed.
- Mining dilution is applied at zero grade and ranges from 6.4%-26.6%. A minimum mining width of 6 inches is used.
- The Mineral reserves were estimated by OSMI. Joanna Poeck, (BS Mining, MMSA, SME-RM) a Qualified Person, reviewed and audited the reserve estimates.

15.3.1 Relevant Factors

SRK knows of no existing environmental, permitting, legal, socio-economic, marketing, political, or other factors that might materially affect the mineral reserve estimate.

16 Mining Methods

16.1 Mining Methods

16.1.1 Mineralized Areas

The resource models were constructed in such a way so as to model just the high-grade vein structures without including mineralized material outside of the structures. In the Revenue area, the main vein and footwall veins have been modeled. The Terrible and Yellow Rose areas each have a single modeled vein. In the mining areas, the veins typically have dips around 70° but vary locally from approximately 50° to 85°.

The Virginius area has been mined historically as shown in Figure 16-1. The 2000 level is accessed from the portal. Lower levels were historically accessed by a shaft/winze located at the 0 north/south point as indicated on Figure 16-1. Previous operators partially constructed two declines in 2014 to 2015 (Virginius South decline and Terrible decline) in an attempt to reach the 2210 level from the 2000 level; however, neither was completed. The main areas targeted for potential underground mining based on current drilling and geology are shown on Figure 16-1. In the mining areas, the Virginius Vein widths typically range from 0.5 to 2.5 ft.

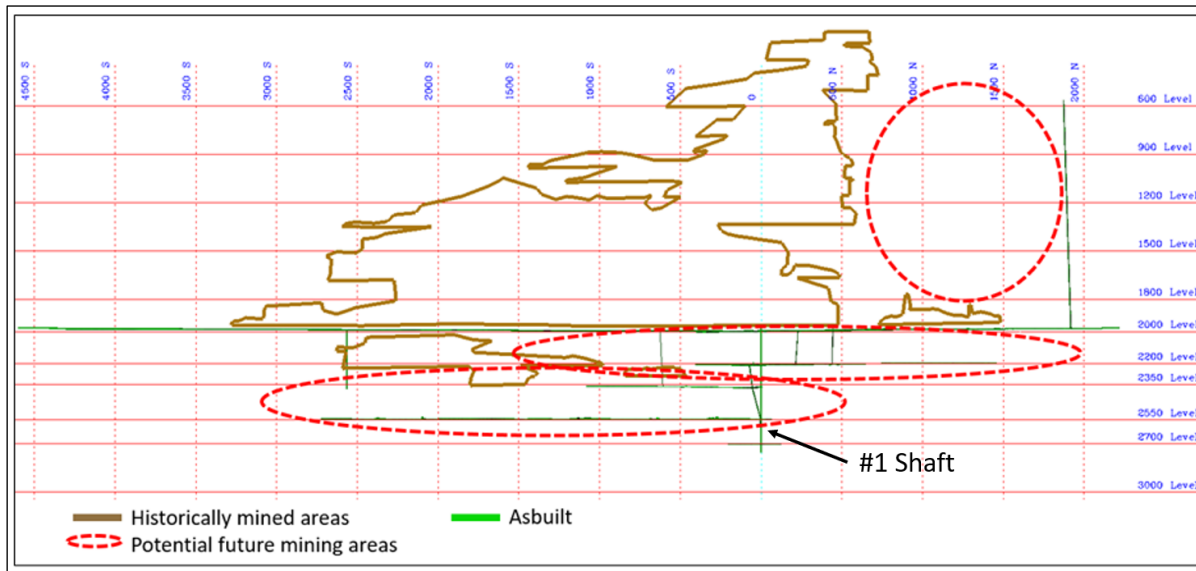

Source: SRK, 2017

Figure 16-1: Long Section of the Virginius Area (Looking Southwest) with Historically Mined Areas, Showing Current Northing and Level Nomenclature

The Terrible area is located to the north of the Virginius area and has a bearing approximately 20° more westward than the Virginius area. Current identified mineralization is above the 2000 level. In the mining areas the Terrible Vein widths typically range from 0.5 to 1.5 ft.

The Yellow Rose area has been somewhat developed historically from the Revenue Virginius Tunnel. Though this vein had been mined historically with significant production at the Yellow Rose Mine, over 10,000 ft away along strike from current workings, records indicate that no significant production had occurred from the Revenue tunnel. The level nomenclature used in the Yellow Rose area is similar to

that used for Revenue. The 0 north/south point is located where the Yellow Rose vein meets the main development coming from the portal. All identified mineralized areas are above the 2000 level. In the mining areas, the Yellow Rose Vein widths typically range from 1.0 to 5.0 ft.

16.1.2 Resue Mining

Based on the orientation and width of the mineralization, review of historic mining, and available geotechnical information, a resue mining method is appropriate where waste rock serves as backfill as the stope is advanced in an overhand manner. This method is highly selective and allows for mining narrow widths down to 0.5 ft. There is a significant amount of high-grade Ag ore carried in narrow vein structures.

More specifically, the resue mining method is explained as follows:

A stope block is identified having minimum approximate dimensions of approximately 500 to 1,000 ft along strike and up to 300 ft in height. Stope block widths vary according to the mineralization. Typically, an off-ore access drift is developed on the footwall along the length of the stope. Two-compartment raises known as cribbed manways, are developed on each end of the stope from the level below providing access to any level of the stope. In the center of the stope a three-compartment service raise with a manway, ore pass, and equipment slide is constructed as the primary access. Each raise will have utilities run up into the stope so that miners can pull water or air from either side of the stope or from the middle service raise.

The bottom portion of the stope, approximately 25 ft in height, is left in a pillar (sill pillar), which is partially recoverable from the stope below. A 3.5 ft wide scam drift is developed along the length of the stope above the pillar. Finger raises with ore chutes at the access level connect the scam drift to the development access below and are used to remove ore material from the stopes. Once the scam and finger raises are established, upholes are drilled into the vein, both in ore and waste. Ore material is blasted first and then removed using slushers operating on a conveyor belt muck sheet to the finger raise for transportation to the process facility. Prior to blasting the waste material, cribbed timbers are placed to raise the ore passes (similarly to the manway and service raises) to the next level. Waste material is then blasted and left in the stope as fill material for accessing the next level of the stope. Where necessary, additional waste can be drilled and blasted to ensure fill volume in the stope is appropriate as mining progresses.

Figure 16-2 and Figure 16-3 show generalized cross sections and long sections explaining the mining method.

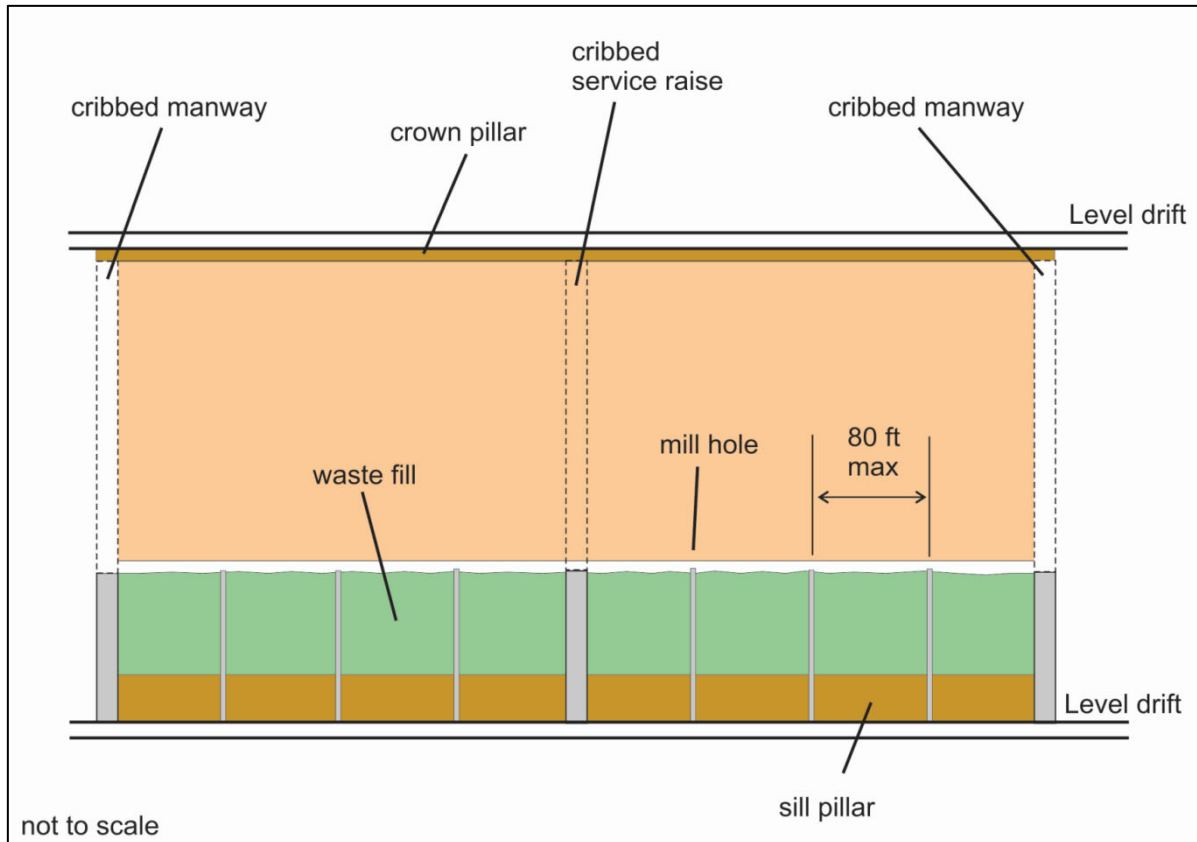

Source: OSMI, 2016

Figure 16-2: Resue Mining Method Details – Long Section

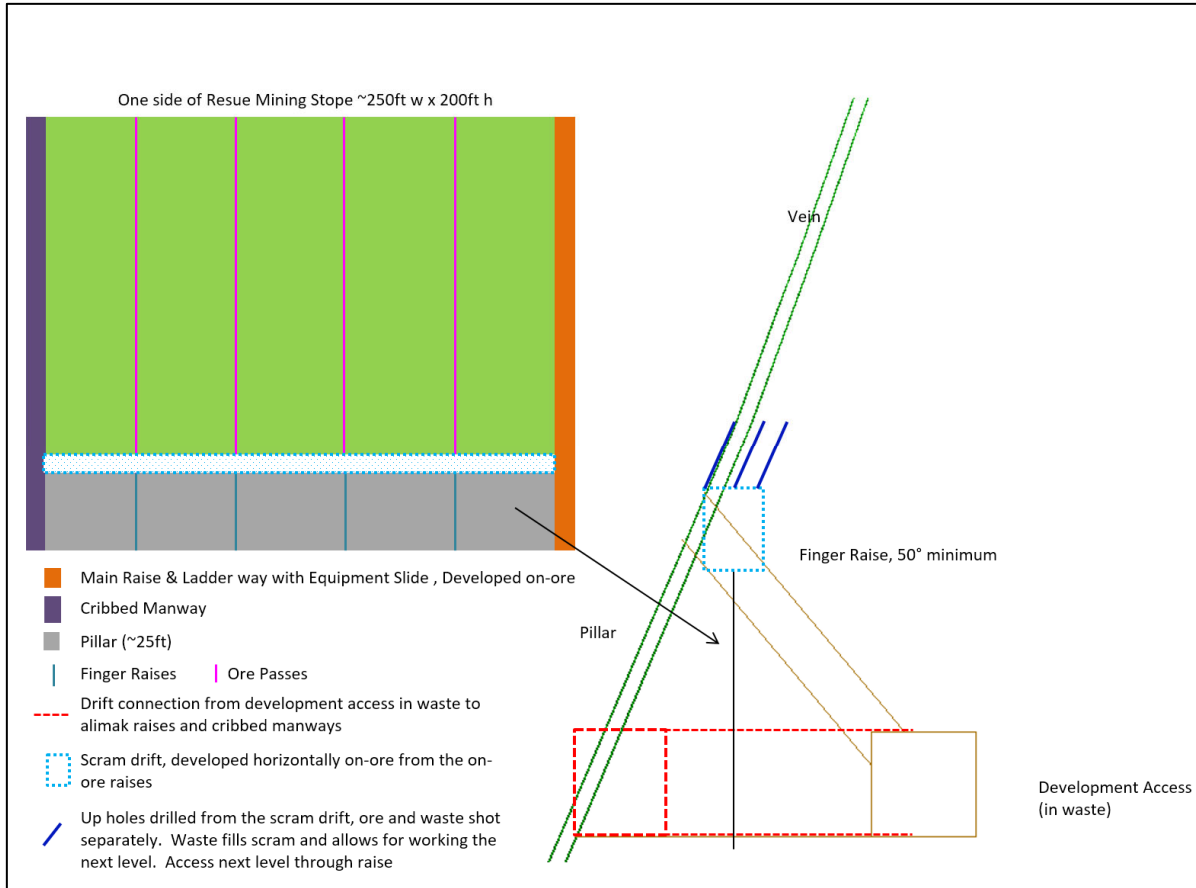

Source: SRK

Figure 16-3: Resue Mining Method Details – Long Section on Left, Cross Section on Right

The resue mining method can be applied in areas where the veins are narrow and sufficient waste material is mined to serve as backfill for miners to advance the stope vertically. In areas where the ore width is excessive (>~5ft), the resue method becomes inappropriate without an alternate means of backfill. Where necessary waste rock will be shot out from the ribs to generate enough material to fill the stope. The resue method was historically used at the mine from 1885 through 1912 when the mine was profitable under the ownership of A.E. Reynolds. The use of this method successfully produced enough ore to feed the historic 400 t/d stamp mill located near the Revenue Tunnel portal. The mill burned down in 1912 which effectively ended the last serious effort to mine the Virginius Vein using the resue method. Later operators in the 1960's and 1980's tried using shrink stoping methods which, due to the need to mine at a wider width, diluted the ore to uneconomic levels.

Shrinkage stoping can be utilized at the mine in stopes where the average vein width exceeds 2.5 to 3 ft of width but is not currently planned for use for any new stope areas.

16.2 Geotechnical Parameters

The average mineralized zone width for resue stopes is approximately 1.5 ft with a minimum mining width of approximately 6 inches. Current experience indicated they can mine the slot 6 to 9 inches wide. Some stopes in the Yellow Rose specifically are generally wider while the Footwall and Terrible stopes are generally narrower than these averages. The total stope widths will vary based on optimum

equipment/operations design subject to maintaining ground stability. Each stope has one raise that includes a manway, ore pass, and equipment chute typically in the middle of the stope, an appropriate number of ore pass raises on approximate 75 to 80 ft centers, and a carried manway on each end of the stope.

Table 16-1 is a summary of the planned drift dimensions and their purpose for which ground support requirements were estimated.

Table 16-1: Summary of Planned Opening Dimensions

Area Type	Width 1 (ft)	Width 2 (ft)	Height (ft)
Lateral Development			
9x9 Track Drift	9.0		9.0
9x9 Track Drift - Jumbo	9.0		9.0
Level Siding	12.0		12.0
Drift Rehabilitation	2.0		2.0
Resue Stope Scram	4.0		4.0
Resue Stope Scram 01	4.0		4.0
Shrink Stope Scram	4.0		4.0
Alimak Raise 3x9 Station Scram	3.0		3.0
Alimak Raise 4x9 Station Scram	4.0		4.0
Alimak Raise 9x9 Station Scram	9.0		9.0
Alimak Raise 10x14 Station Scram	10.0		10.0
Alimak Raise Dog Holes	3.0		3.0
Alimak Standard Nest	10.0		10.0
Alimak Hoist Nest	10.0		10.0
Station Enlargement	12.0		7.0
Shink Cut & Hog Pockets	6.0		8.0
Vertical Development			
Level Dump Raise	6	6	
Alimak Muck Raise	4	4	
Alimak Standard Raise	6	8	
Alimak Hoist Raise	7	12	
Alimak Finger Raise	6	6	
Alimak Chute Raise	8	8	
Carried Manway Raise	6	8	
Resue Chute Raise	4	4	
Service Manway Raise	6	12	
Alimak Box Cut	7	12	
Raise Sump Excavation	12	10	
Timbering and Hoists			
Timbering Standard Raise	8	8	
Timbering Hoist Raise	10	14	
Timbering Alimak Finger Raise	6	6	
Timbering Carried Manway Raise	6	8	
Timbering Service Manway Raise	6	12	
Resue Chute Package	4	4	
Alimak Chute Package	8	8	

Source, Aurcana, 2021

A typical spacing of 300 ft between levels has been used in all mining areas (Virginius Main, Footwall, Yellow Rose and Terrible) mining areas. The resue mining method is a modified cut and fill method designed to fit the mineralization and minimize dilution. The areas are overhand mined from bottom to top with the use of sill pillars where necessary. Waste rock from the resue method is used to fill the

cut and work from for the next resue cut. This method helps to provide local stope stability as well as mine-wide stability.

Underground mining areas will be accessed via the Revenue tunnel and generally footwall accesses except where there is pre-existing development such as the 2350 level south which was driven in the 1980's. The footwall access and any other infrastructure will be in footwall areas away from mining-induced stress areas. Mined material below the 2000 main level other levels will be hoisted to the Revenue Tunnel and rail-hauled to the underground mill near the surface. Ventilation raises / shafts will be constructed / rehabbed to connect the main ventilation system.

16.2.1 Geomechanical Characterization

SRK has conducted a geotechnical evaluation of the Project (SRK, 2016). Geotechnical core logging, structural mapping of drifts, and laboratory strength testing of drill core samples were used to characterize the mineralized rock and surrounding host rock. The characterization programs consisted of the following components:

- Geotechnical logging of 1,274 ft of core from 14 diamond drillholes. Drillhole stations were located on one level (2,000 ft level) and drilled perpendicular to the strike of the deposit, therefore intersecting the hangingwall, footwall, and target veins
- Drift face mapping from 30 stations in existing access drifts
- Historic laboratory strength testing of 38 core samples. Tests included uniaxial compressive strength (UCS), triaxial compressive strength (TCS), Brazilian tensile strength (BTS) and natural-joint direct shear strength (DSS) tests.
- New laboratory strength testing of 20 core samples. Tests included uniaxial compressive strength (UCS), and Brazilian tensile strength (BTS)
- Rock mass classification of core logging data according to the Barton (1974) Q and Bieniawski (1989) RMR systems

The laboratory testing was conducted to confirm rock strengths from historic tests. Samples of the immediate hangingwall and footwall material as well as the mineralized ore vein were sampled from 10 exploration drill cores. Twenty samples were tested by Agapito Associates in Grand Junction, Colorado. The test standards included the following:

- Uniaxial (unconfined) compressive strength (UCS) test: D7012-132
- Splitting tensile strength test (Brazilian): D3967-083

The laboratory test results (Agapito, 2017) confirm rock strength values used for the FS design. Table 16-2 is a summary of the average and standard deviation values from the testing. Because only a limited number of tests have been conducted, SRK recommends that 33-percentile values be used for design purposes.

Table 16-2: Summary of 2017 Laboratory Testing Program

Location	Density		UCS		Young's Modulus (Secant)		Poisson's Ratio (Secant)		BTS	
	Average (lbs/ft ³)	Standard Deviation (lbs/ft ³)	Average (psi)	Standard Deviation (psi)	Average (10 ⁶ psi)	Standard Deviation (10 ⁶ psi)	Average	Standard Deviation	Average (psi)	Standard Deviation (psi)
FW	168.9	2.4	15,342	5,289					1,407	397
HW	167.4	2.1	16,431	4,120	3.22	0.54	0.04	0.02	1,532	603
Dike/Ore	169.5	3.1	33,385	13,411	9.92	0.11	0.16	0.01	2,641	560

Source: SRK, 2017

16.2.2 Geomechanical Domains and Rock Mass Properties

The Virginius Vein was divided into four structural-geotechnical domains, the hangingwall (HW), dike (Dk), which includes mineralized vein, footwall (FW), and the country rock of the San Juan Formation (SJ). These domains were based primarily on the visible geologic structure near the vein, historic ground conditions, and the characterization data. The domains were used as the basis for developing the geotechnical design parameters. Individual rock types (i.e., San Juan Formation versus andesite dikes, with or without vein material) do not appear to be the dominant factor controlling rock quality domains when compared to geologic structures. The data used to estimate these domains is representative of the stopes mined in the first years of the mine plan. Little geotechnical data has been gathered at distances farther than approximately 280 ft above or 200 ft below the Revenue level due to current limited access.

A summary of rock mass quality is shown in Table 16-3 for the characterized mine area. Observations from a recent site visit confirm this range of Q' values in the stope areas.

Table 16-3: Summary of Rock Mass Quality, Virginius North Area

Area	Zone	Lithology	Q'			Quality
			Average	Min	Max	
Virginius North	SJ-FW	Rhyodacite	21.8	16.7	39	Good
Virginius South	SJ-FW	Rhyodacite	32.7	27	45	Good
	Dk-HW	Andesite	28	-	-	Good
	Mineral	Quartz Carbonate	1.6	-	-	Poor
Terrible	SJ	Rhyodacite	32	28	41	Good
Revenue Tunnel	SJ	Rhyodacite	17.7	11.2	28	Good
Yellow Rose	SJ	Rhyodacite	19.6	5.3	37.5	Good

Source: SRK, 2016

16.2.3 Mine Design Parameters

The stable open stope dimensions were estimated using the Potvin (2001) method. The size of the open stope area in this study are 12 ft high (assumed 6 ft drift plus 6 ft long resue slot), up to 6 ft wide vein; and 500 ft long oriented along vein strike. The stability charts demonstrate that the selected resue stope sizes are sufficient to maintain stability during mining. Increasing the stope length has limited influence on stope stability and stopes 1,000 ft long should also be stable. Additionally, modifying the stope height to 15 ft (9 ft drift, 6 ft long resue slot) also has minimal influence on stope stability because the hydraulic radius is small compared to stability limits.

Where necessary, remnant dip pillars between stopes will be left in-situ allowing stopes to remain unfilled (i.e., shrinkage stopes are not backfilled). The size of dip pillars should be 1.5 times the width of mined vein, if the strike length is limited to approximately 170 ft.

Ground support requirements were estimated using empirical support charts developed by Barton (1974) and are summarized in Table 16-4. Observations from a recent site visit confirmed that this bolting is adequate in long-term entries and accesses.

Table 16-4: Ground Support Requirements (Barton Method)

Q	Rock Classes	Support Categories	Support Recommendation	Excavation Type
>10	Good	SC-1	Spot Bolting with spacing 7.5 to 8.2 ft	Footwall Accesses Stope Accesses
4 to 10	Fair	SC-1	Spot Bolting with spacing 6.9 to 7.5 ft	Footwall Accesses Stope Accesses Scram Drift
1 to 4	Poor	SC-1	Spot Bolting with spacing 5.6 to 6.9 ft	Footwall Accesses Stope Accesses Scram Drift

Source: SRK, 2016

Resue stopes will be backfilled as part of the mining process. This will limit the amount of sloughing and disturbance to the hangingwall on the active cut level and will help maintain overall mine stability.

Ore passes and ventilation raises will be located outside areas of high mining-induced shear stress areas such as abutments at the ends of the stopes/mining. Long-term ore passes will be in stress shadow areas (i.e., lower σ_1 stress) away from active stoping areas and should be kept full of rock to reduce damage to side walls from tumbling rocks.

16.2.4 Stopping Sequence and Sill Pillars

To reduce the potential for elevated mining-induced stress concentrations, stopes should be sequenced from the middle portion of the mining area outward, pushing stresses away from mining areas toward outer abutments.

The current underground mine plan will result in sill pillars that are to be mined later in the mine sequence. Sill pillars will have stress concentrations, which could possibly yield the rock mass in some areas prior to recovering the entire sill pillar. As such, achievable sill pillar recovery may be less than 100%. With the current knowledge of ground conditions, 80% recovery should be achievable by slowing the extraction sequence. The design has assumed that these sill pillars will be approximately 25 ft high and the width of the mineable vein wide. SRK assumes that 20 ft of the ore in the sill can be safely recovered from the level below, however in the LoM plan presented herein, no stope pillar recovery is currently included.

16.3 Mine Design

16.3.1 Historically Mined Areas

The area has been historically mined by various owners/parties. Historic long section maps, such as the one shown in Figure 16-4 are available and have been used to block out general areas, which are believed to be mined. Level section maps were also located, and drift work shown on the maps was digitized into the computer. This digitized information is believed to reasonably represent the historic workings; however, elevations and exact locations may be inaccurate. Where possible and available survey information has been reconciled with the historical data. This effort is an ongoing process being conducted by OSMI.

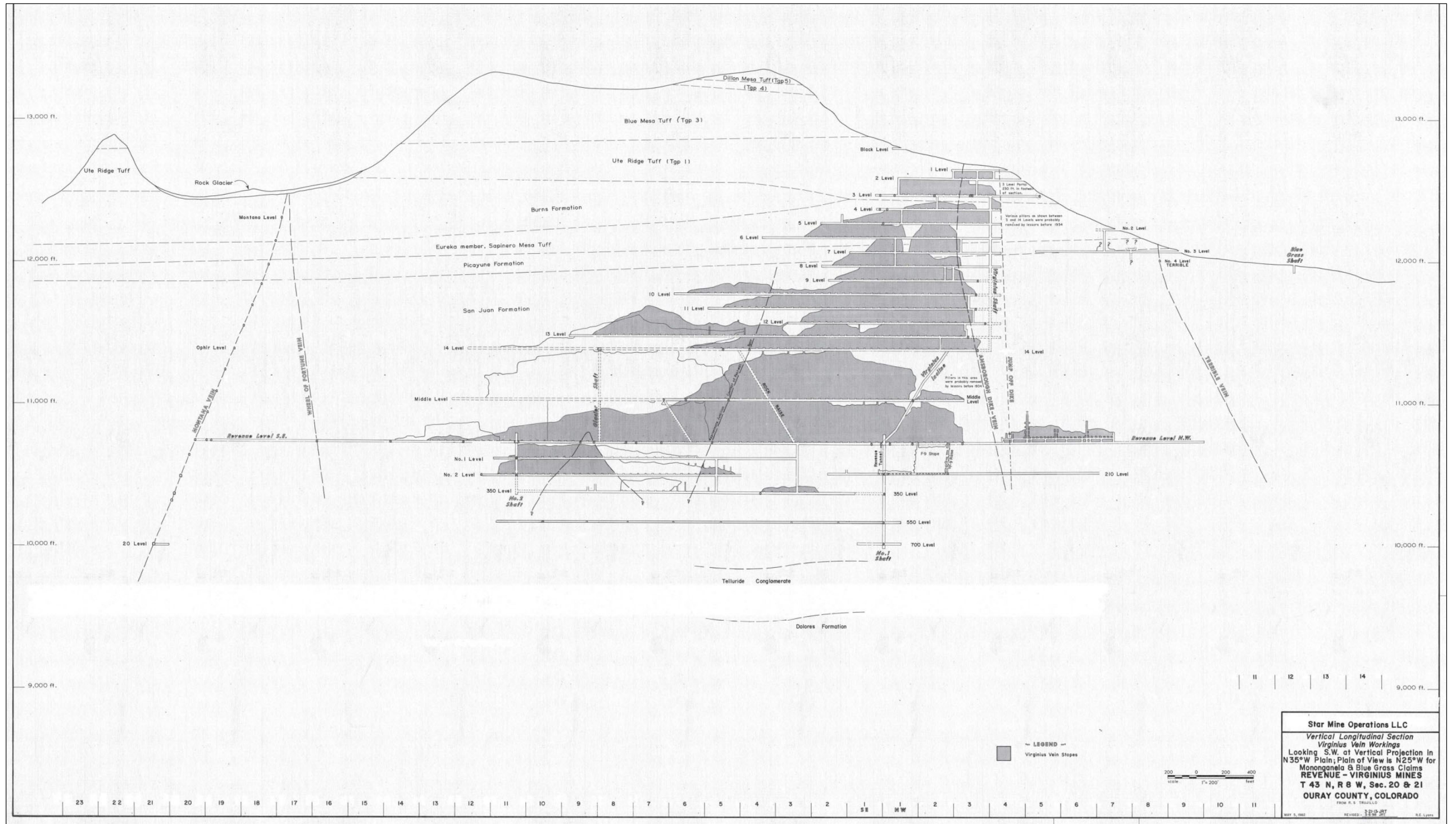

Source: SRK/OSMI; picture of historic map, 2017

Figure 16-4: Longitudinal Section through the Virginius Vein, showing the Stratigraphy and Historic Mining

Additionally, there is 3D survey information available for areas of the mine that have been accessible in recent years and where current development is being completed (referred to as the Ranchers survey). This information was provided by OSMI in the form of a dwg file. To obtain this data, OSMI hired the previous Ranchers Exploration Mine Manager, Bob Larson, who retained the original survey, assay and geology data in digital and paper format. Bob Larson is a Colorado Registered Land Surveyor, and operates Monadnock Mineral Services, Monadnock was able to recreate the data in the mine’s existing coordinate system for all of the workings below the 2000 level which were surveyed by Ranchers Exploration.

There is potential error in the exact location of mined out areas along with encountering unexpected mined out areas, which may be filled with water. Monadnock Mineral Services has been contracted to recreate in the mine grid coordinate system the historic mined out workings and levels from paper copies which predate the Ranchers Exploration work and are in his possession. This information will assist OSMI in identifying areas where precautions should be taken, such as probe drilling ahead of mining, to ensure safe working conditions.

OSMI has stated that it has in its possession all claim deeds and patent surveys. OSMI has also contracted with Monadnock earlier this year to obtain all patent survey notes in order to resurvey where needed claim corners that might be missing in the field. This type of work around the surface facilities has been completed and will continue in and around certain claims in Governor Basin where surface disturbance or avalanche may have removed claim corners. Additionally, Wolcott, a professional land services company based in Grand Junction, Colorado, was contracted in 2016 to review all ownership records and recreate all claim maps in proposed mining areas for this LoM plan. This work was completed for claims where mining will proceed during the LoM plan in 2017 and work will continue through 2018 on other claims outside claims where apex law controls minable reserves. SRK has not verified this work.

OSMI has completed the vertical access and main 1800 level drift as well as stope access for two stopes on the 1800 level as shown in Figure 16-4 below. OSMI conducted preliminary rescue mining in stopes 1080-580N and 1080-1830N8, but full production was halted to focus on further completion of additional development to fully develop the 1800 level, 1500 level, and 900 levels for production prior to going into full production.

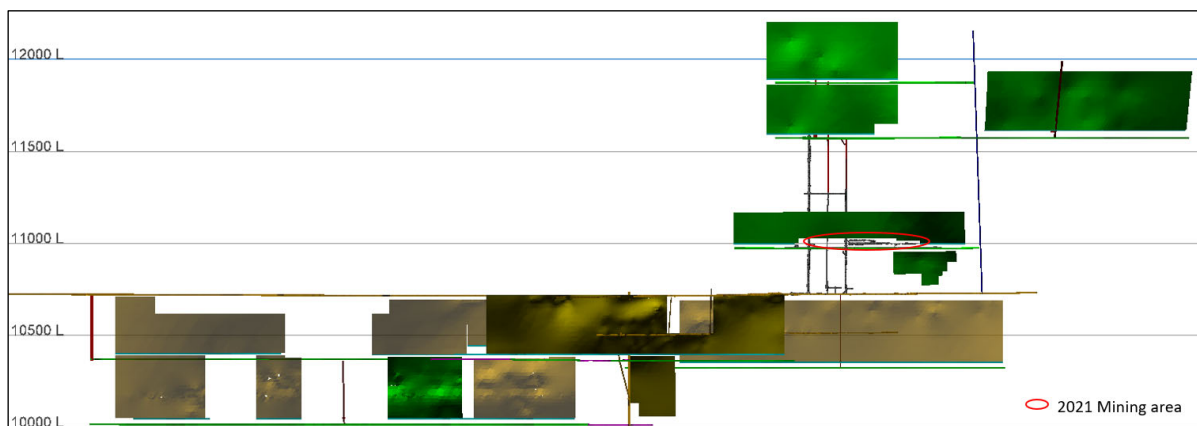

Source: SRK, 2021

Figure 16-5: Long Section View of Mining Shapes in the Virginius Area

16.3.2 Stope Design

The resource block models provided for all areas consist of a single block across the width of the vein. It is assumed that if a vein is included in the mine plan, the full width of the vein is mined.

Figure 16-6 through Figure 16-9 show long section views of the resource model for various veins with blocks colored by in situ NSR.

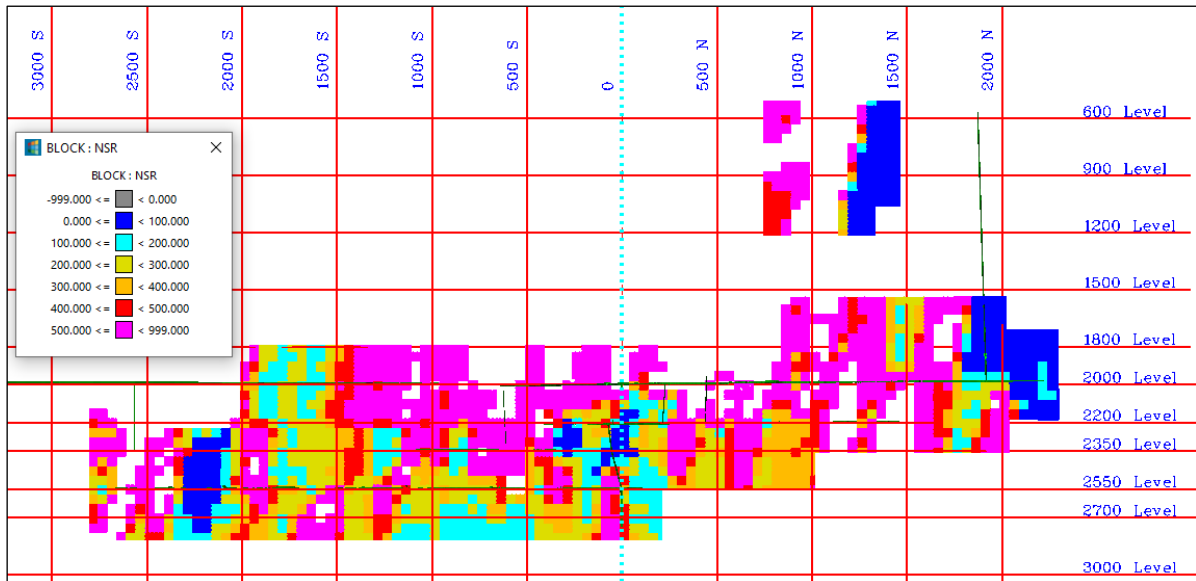

Source: SRK

Figure 16-6: Virginius Main Vein Resource Blocks – Colored by NSR

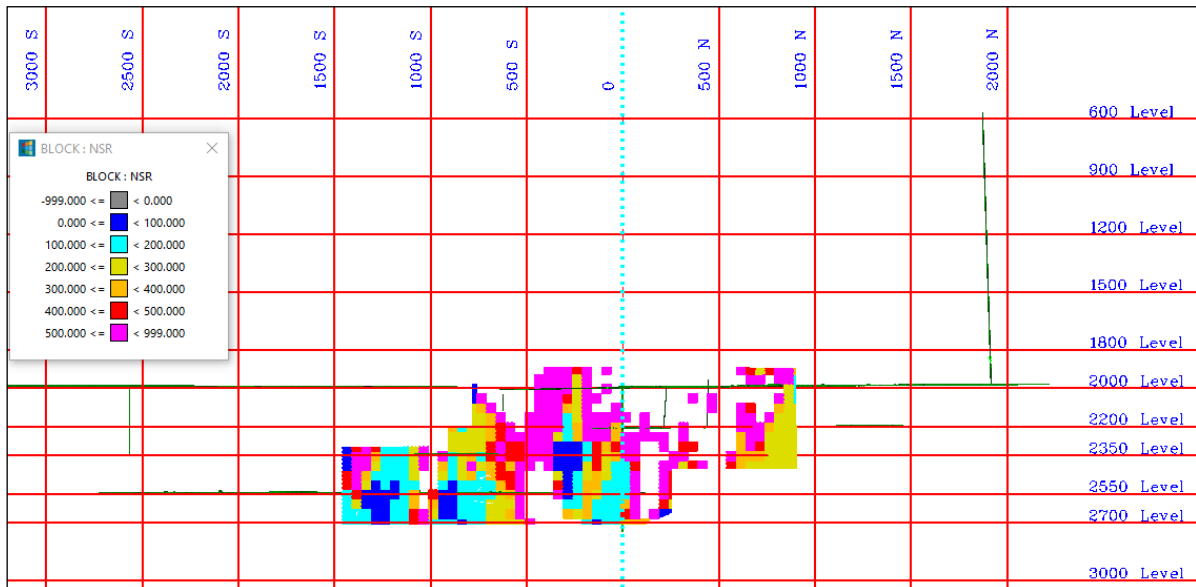

Source: SRK

Figure 16-7: Virginius Footwall Vein Resource Blocks – Colored by NSR

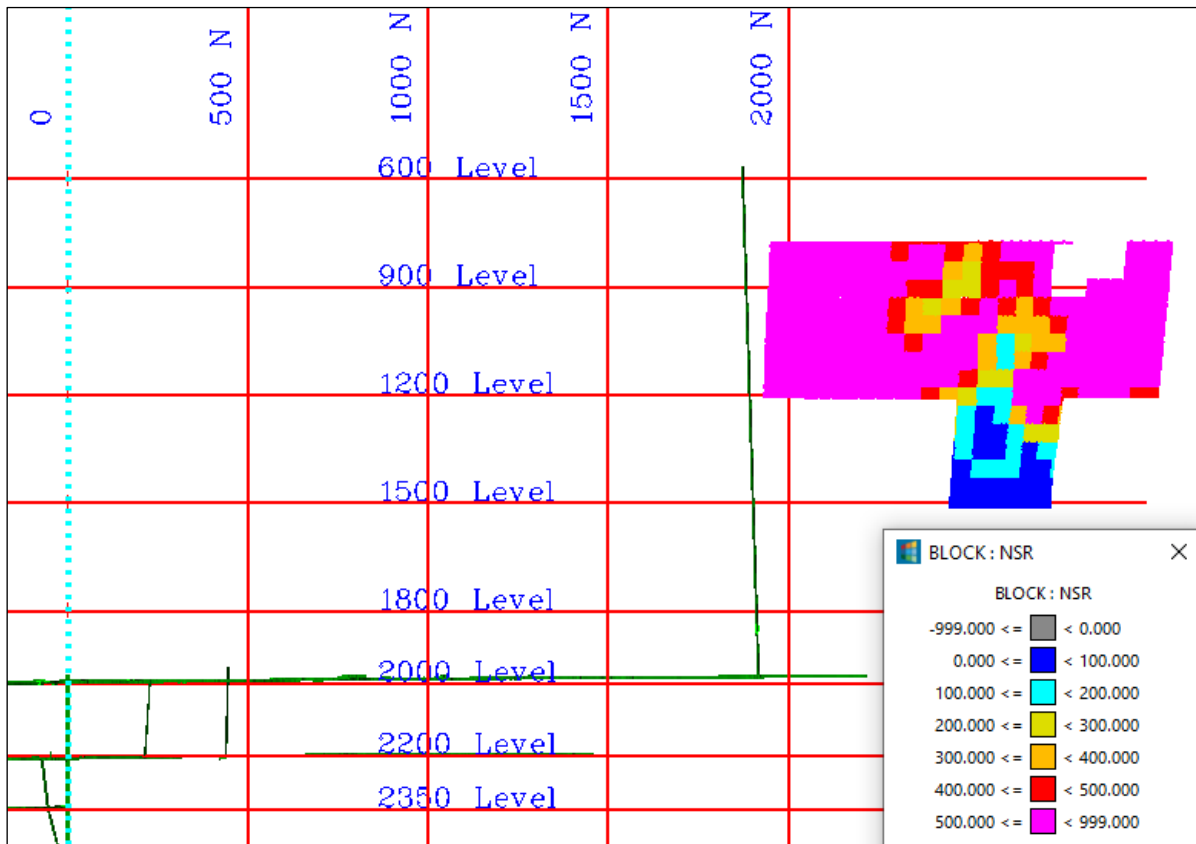

Source: SRK

Figure 16-8: Terrible Vein Resource Blocks – Colored by NSR

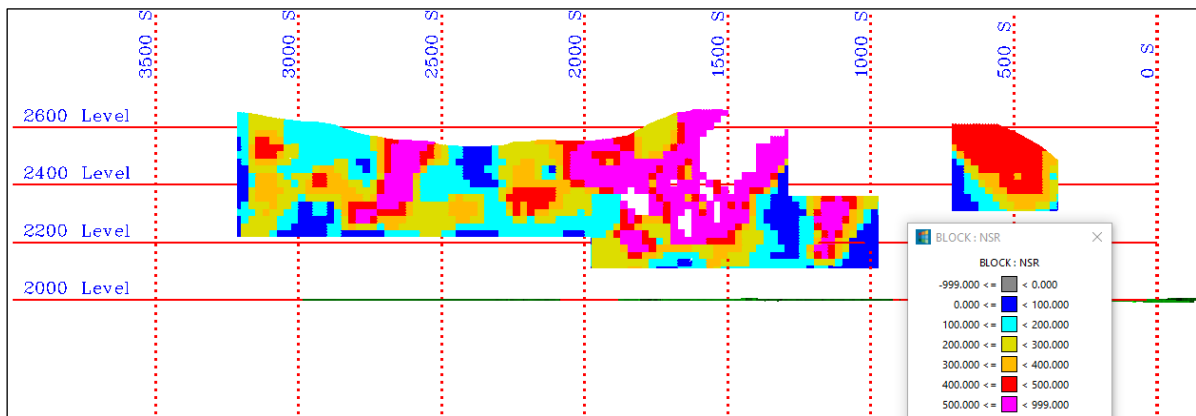

Source: SRK

Figure 16-9: Yellow Rose Main Vein Resource Blocks – Colored by NSR

Based on the NSR of the blocks, large mining panels/stopes are manually identified in long section. There may be places inside the panel which fall below CoG, these areas fall into two categories: incremental ore which though below cut-off still has an economic benefit due to being located in an already developed stope and low-grade mineralization that may be bypassed in the ore cycle and

taken during the resue waste shot. These lower grade areas are included in the reserve and in the LoM plan described herein. The decision on whether to take low grade material will be the responsibility of the OSMI geologic staff in their daily mapping and sampling along with proper communication with mine operations staff. Note that the overall NSR within each stope shape, including the low grade, is above CoG.

The geologic vein shape is cut to the mining panels/stopes and tonnages/grades are reported for each stope. Dilution is calculated in the block model for each block, based on the specific block width, and is also reported to give an average dilution for the entire stope. Tonnages/grades are then diluted, based on the average dilution, in a spreadsheet. The average diluted grade of the entire panel is then compared to the CoG to ensure economic viability.

The minimum mining width stated by OSMI is 0.5 ft. There are very few areas that fall below the 0.5 ft, and as such, during the stope design process no additional minimum mining width dilution was included. Note that if extremely narrow areas are encountered, they may be mined with a waste shot so as not to dilute the grade to the mill. Proper mine planning and geologic mapping will allow these areas to be quickly bypassed without loss of significant production tonnage.

Included in the mine plan is a single shrinkage stope (named F9) which is fully developed and ready to muck. The stope is believed to be mined at 3.5 ft wide, as per OSMI's discussion with the mine manager at the time that the stope was developed. Tonnage and grade of the vein for this stope were calculated from the resource model and diluted to 3.5 ft wide. Records indicate only 800 t of the stope was shipped to processes and the remaining is stockpiled in various muck passes from the 2210 to the 2550 level. The quantity of the material which will be recovered from this stope and the various muck passes cannot be confirmed at this time; however, the entire stope tonnage has been included in the mine plan. Recovering only a portion of this tonnage is not seen as a material change to the reserves, nor to the cash flow as it is currently shown as being milled at the end of the LoM.

16.3.3 May 2017 Resue Test Stope Discussion

The stope dilution applied to the mine plan is described in Section 15.2.2. Subsequent to the mine planning work, additional test stope mining was performed to further confirm the understanding of implementation of the mining method, productivities, and dilution quantifications/discussion. A discussion of the May 2017 test stope activities and results is included in this section. This information supports the FS assumptions; however, this information was not directly used in material quantity/grade estimates for the FS.

Drill Pattern

During the April 2016 test stope (described in Section 15.2.2), a number of drill patterns were tested to determine the best pattern to minimize dilution, reduce the probability of booting a round, and break the ore into size fractions that are easily slushed to the resue ore passes.

The 2-1-2 drill pattern was found to be the most effective pattern to pull the mineralization zone (vein) in a resue stope. The 2-1-2 pattern allows for the miner to drill faster throughout the mineralization zone, although the miner must be correct on his angle relative to that of the hanging wall for particular holes. This pattern also allows for some flexibility in the requirement to be parallel to the hanging wall so that when setting up, the miner only needs to make sure the single hole nearest the hanging wall is parallel. The other two holes (hole nearest the footwall contact and single hole by itself) can be sub-parallel without endangering the entire round or increasing dilution significantly.

It was determined that the 2-1-2 pattern, shown in Figure 16-10, was superior to other potential patterns, such as a 1-1 staggered pattern, simply because if one hole fails in the staggered pattern the miner will lose the rest of the shot. So, although 2-1-2 pattern takes longer to drill and uses more powder it was found to ensure that the mineralization zone pulls significantly better and cleaner even if one hole fails.

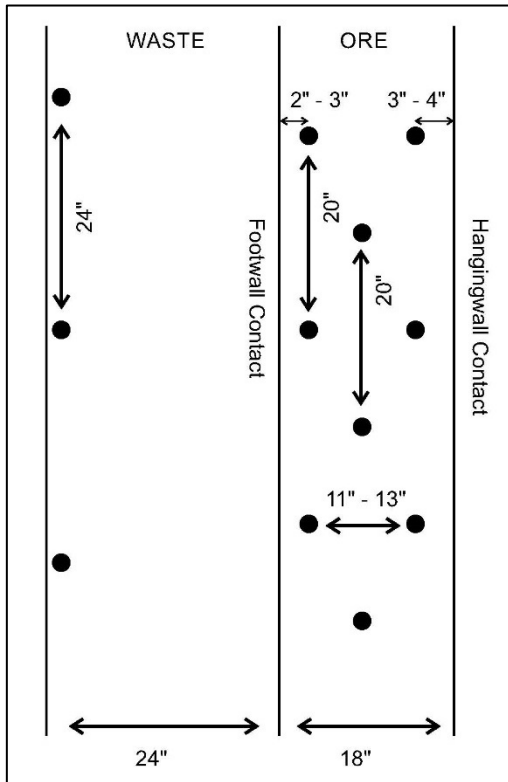

Source: OSMI 2017

Figure 16-10: Resue Drill Hole Pattern Used the 561 Test Stope

Resue Test Stope – May 2017 Summary

OSMI further developed and advanced the 561-test stope from March to May in 2017 with the intent of further confirming the dilution estimate, to evaluate swell factor for the waste remaining in the stope, and to compare productivity estimates in the mine plan to real data. The test was based on mining a 45 ft section of the stope with an experienced miner and a 25 ft section of stope with a junior miner. A full cycle including drilling and blasting the ore, placement of muck sheet (conveyor belt), slushing ore to ore pass, raising the timbered ore passes and manways, and drilling and blasting the waste to complete the cycle. The three-man crew made up of an experienced Miner I, a less experienced Miner II and their shifter who basically functioned as a miner’s helper (nipper).

The stope was surveyed on 5 ft centers prior to activities commencing. The test mining activities were timed, and stope dimensions were surveyed as each portion of the mining cycle progressed. Figure 16-11 shows the test stope area and sequence of mining. The carried manway was driven first and timbered after which the lead miner drove scam while the shifter and Miner II drove the service raise and timbered both it and the raises from the previous test stope constructed in 2016.

The two new raises (service and carried) were driven and timbered as per feasibility design. Following timbering and installation of utilities in each raise (water, air and ventilation), a 3.0' wide scam drift was mined first, noted as 1st in Figure 16-11. The #11 section of resue ore and waste was mined second (2nd). The final section of resue, #9 section, was mined last (3rd). After activities commenced, each 5 ft section of drift was surveyed after the ore shot, after the ore was mucked out, and finally after the waste shot was taken. These surveys were used to compare against the pre-mining survey.

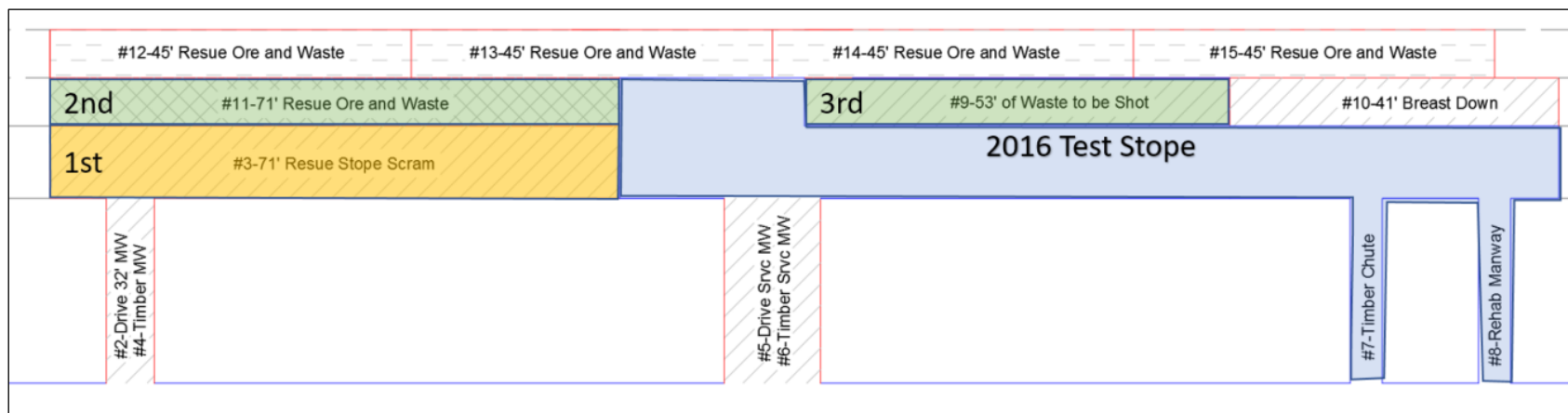

Source: OSMI 2017 modified by SRK

Figure 16-11: Test Stope Area and Sequence

Resue Test Stope – May 2017 Dilution

The vein averaged approximately 13.3 inches in width and was drilled in a 2/1/2 pattern on one-foot centers in the ore as described above. A single hole was placed in the waste on approximately two-foot centers on the footwall side of the scam drift. The vertical resue cut was 6 ft high and followed the vein dip. The vein width in the test stope ranged from 6 inches to 2 ft.

The overbreak, which represents the dilution, was measured every 5 ft down the stope. The typical ore shot breakage can be seen in Figure 16-12. The upper portion of the ore shot is clean and typically broke to the waste. The bottom 1.6 ft of the hole on average consistently over-breaks and creates the dilution portion of the shot. For the test stope, this overbreak ranged 6 to 1.5 inches to 3 ft. The width of the overbreak averaged 1.8 ft. The minimum width of the overbreak was 8 inches and the maximum was 1.9 ft.

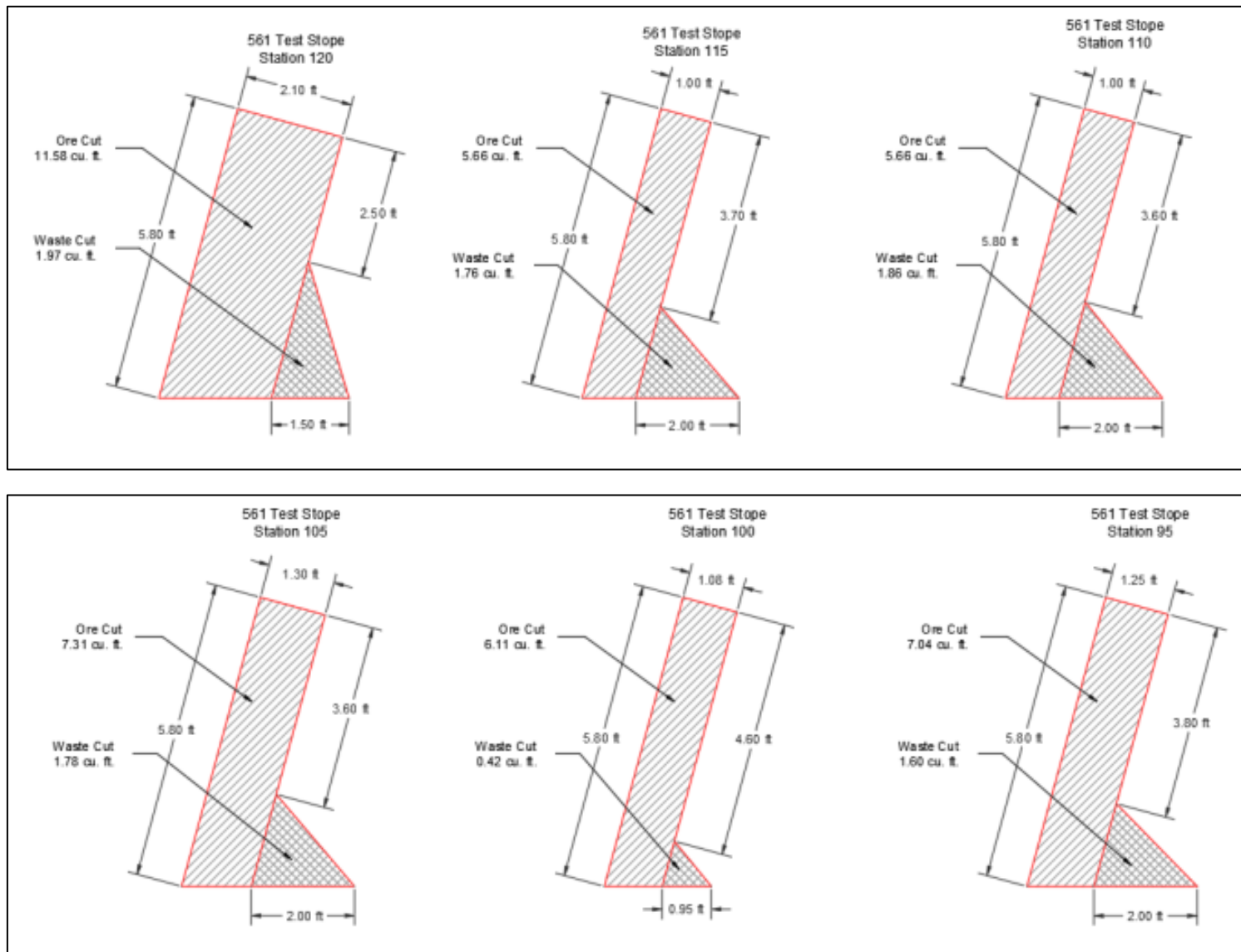

Source: OSMI, 2017

Figure 16-12: 561 2017 Test Stope Measured Overbreak Results

Table 16-5 summarizes the stations, vein widths, and actual dilution for the May 2017 test stope.

Table 16-5: May 2017 Test Stope Measurements and Dilution Calculation

Section	Average Vein Width	Ore Cut (ft ²)	Waste Cut (ft ²)	Dilution (%)
200	1.36	6.66	0.1	1.48%
205	1.2	5.67	0.96	14.48%
210	1.03	3.64	1.82	33.33%
215	1.1	5.41	3.31	37.96%
220	0.97	3.83	0.66	14.70%
225	1.09	4.7	1.18	20.07%
230	1.2	6.32	0.74	10.48%
235	1.14	6.48	1.37	17.45%
240	1.26	6.32	1.06	14.36%
245	1.28	6.11	1.6	20.75%
250	1.32	6.52	1.59	19.61%
255	1.24	4.88	0.19	3.75%
300	0.83	5.41	6.21	53.44%
305	1.08	5.46	4.21	43.54%
310	1.34	5.54	1.9	25.54%
315	0.93	4.43	5.32	54.56%
320	1.01	6.02	6.78	52.97%
325	0.64	2.68	4.08	60.36%

Source: OSMI, 2017

A best fit line was created from both this data and the 2016 data and a new best fit equation developed. Overall, the results of the equation differences were minimal and therefore adding confidence to the 2016 dilution equation used in this FS.

Impact of Miner Training and Experience

A section of the May 2017 test stope was mined by the Miner II who had no prior training using a stoper drill until this test stope was undertaken. Mine management was interested in the potential outcome of an inexperienced miner completing a small section of the stope and sought to determine what issues were critical in training seasoned miners who had no prior experience in narrow vein mining using a stoper drill. It is very clear that proper training in a real environment as envisioned by the OSMI proposed stoping school will be an important activity to assure dilution is kept to a minimum. OSMI plans to develop training that addresses the types of issues that a miner might experience when executing the rescue mining method. This training is described further in the Implementation Section of this report (Section 24.1.2). The May 2017 dilution equation evaluation includes all data from both the experienced Miner I and inexperienced Miner II. The experienced miner effort in the May 2017 test stope date resulted in lower dilution than forecast by the 2016 equation.

As additional data is available the dilution equation should be updated during operational phases of production.

Swell

Utilizing the same survey data, the waste swell factor was calculated as part of the test stope process. The data is somewhat erratic, but an overall swell factor of 30% was estimated. This study, consistent with previous work maintains the 40% swell factor, but OSMI will be able to monitor this factor as the rescue method is put into operation to further confirm the swell factor. The swell factor quite simply

indicates the proper amount of material required to balance the waste for access to the next lift and utilizing the 40% swell factor in the study allows a conservative estimate of any excess waste that may occur in the mine plan. These quantities were identified in the mine block model and determined to be manageable within the stope.

Stope Productivity:

The third objective of the May 2017 test stope was to test the ability to drill and cycle a round in simulated mining conditions. The goal was to be able to drill, blast, and muck a 45 ft round in eight hours. OSMI produced a summary of the production during the stope productivity test that is summarized in Table 16-6.

Table 16-6: May 2017 Test Stope Drilling Productivity Results

Test Distance	Goal (hours)	Actual (remove irregular down time) ⁽¹⁾	Percent over/under
45 ft - Station 10 to 45, and 110 to 120	8.00	9.00	13%
20 ft - Station 120 to 140	3.56 ⁽²⁾	4.37	23%
Weighted Average Results	6.63	7.58	14%

Source: OSMI 2017, modified by SRK

(1) Slusher replacement not available.

(2) Goal adjusted to equivalent of 45 ft.

The following observations were made during the process with respect to productivity:

- The two miners and their nipper who were timed in the cycle had not previously worked in a resale environment and as such had no prior experience with the overall cycle
- The test stope did not represent steady state production scenario
- Greater than average interruptions by survey, supervision, and inspections disrupted the workflow
- The test included only a single heading with only two-man crew with nipper versus actual full stope with a five-man crew that would occur during operation
- Maintenance downtime (slusher issue) was exacerbated by the current non-production state of mine without a spare slusher available to replace the slusher of the appropriate size that malfunctioned
- Testing with an inexperienced miner that was not proficient slanted the productivity numbers lower and had a significant dilution impact
- This was the first OSMI experience with placement of conveyor muck sheet and the sheet rolled up slightly during slushing due to the way the conveyor was placed
- Proficiency with new mining method and positioning of the stoper, use of kicker board
- General knowledge of the rock conditions and experience with the narrow vein system could have impacted the overall productivity

All the items were documented are readily resolvable with proper training.

During the pre-production ramp up period final methods, sufficient training, spare parts and contingency plans were refined to confirm operating efficiencies will achieve day to day production requirements. Actual operating learnings including costs and productivity information has been incorporated into the updated mine plan and mine schedule. Dilution estimates appear consistent with the equation developed for dilution estimation.

16.3.4 Development Design

The main access to the mine is via the Revenue Tunnel portal (10,600 ft amsl). Approximately 300 ft to the east is the portal entrance to the mill, which is located underground at the same elevation. The underground mill connects to the Revenue Tunnel underground at a location approximately 300 ft in from the main portal of the Revenue Tunnel. A borehole exists on the north side of the Revenue Vein.

The 8 ft diameter 1,600 ft vertical borehole (referred to as the borehole, ventilation hole or the Hubb-Reed raise) provides secondary egress and ventilation. This borehole, developed in 2013, was rehabilitated during the pre-production period prior to this report including permanent ground support. A hoist/elevator system, ventilation modifications, and the addition of four shaft stations for access to stopes and to allow exploration drilling and mining above the Revenue level remain to be constructed. The existing mine emergency hoist and bullet style cage remain in service at present.

The existing Revenue Tunnel has three different caved sections along its 7,800 ft from portal to shaft. OSMI has completely rehabbed the drift from the main Revenue tunnel to the vent hole. Additional work in this area was completed during pre-production for access to the main Alimak #1 shaft as well as muck passes and sidings. As part of mine development a new footwall lateral will be driven to the south end of the deposit on the Revenue level to connect with a raise coming from levels below. Rehabilitation of historically mined drifts on lower levels is included in the mine plan. Additional development/rehabilitation may be required depending on exact location of the existing drifts once they are located/surveyed underground. Note that all drifts currently planned for rehabilitation were surveyed in the 1980's by Ranchers Exploration.

Access to lower levels will be via the existing #1 Shaft, which is currently flooded and, although accessible at the 2000 level of the Revenue Tunnel, is inaccessible at depth. The #1 Shaft rehabilitation includes pumping the water, rehab of the main hoist cut-out on the Revenue 2000 level, rehab of the existing hoist structure, rehab of 750 ft of shaft from the 2000 Revenue Tunnel level to bottom of the shaft, installation of a hoist, skips, and man-cage as well as development/rehabilitation of loading pockets and ore passes. The rehabilitation is expected to take seven months to complete and occurs in year 2 of the FS mine plan. A shaft station will be available on each planned operational level to move men/materials to the Revenue level. An existing ore pass from the 2210 level to the 2550 level will be rehabilitated and as part of the rehabilitation new ore and waste pockets for loading skips will be developed on each operating level.

The Yellow Rose area currently does not have a usable secondary egress route. The initial Alimak raise developed in the area will be extended to surface and will include a permanent hoist located in one of the compartments. This raise will function as an emergency egress and ventilation raise.

A 3D design of the development was completed and is shown in Figure 16-13 and Figure 16-14.

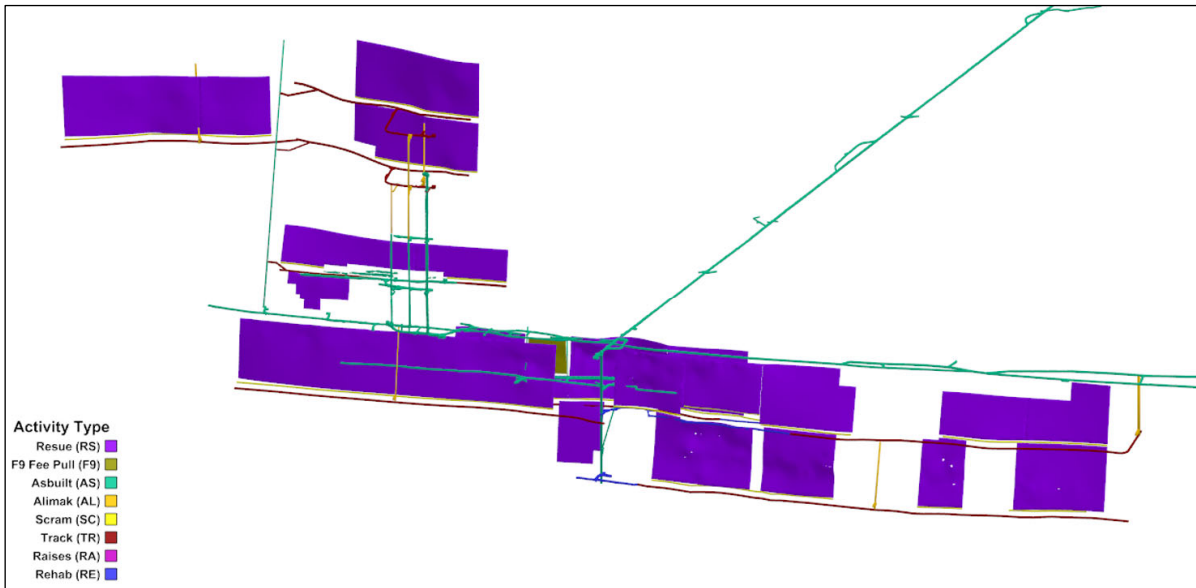

Source: SRK

Figure 16-13: Revenue and Terrible Area Planned Development (Rotated View- Looking Toward Portal)

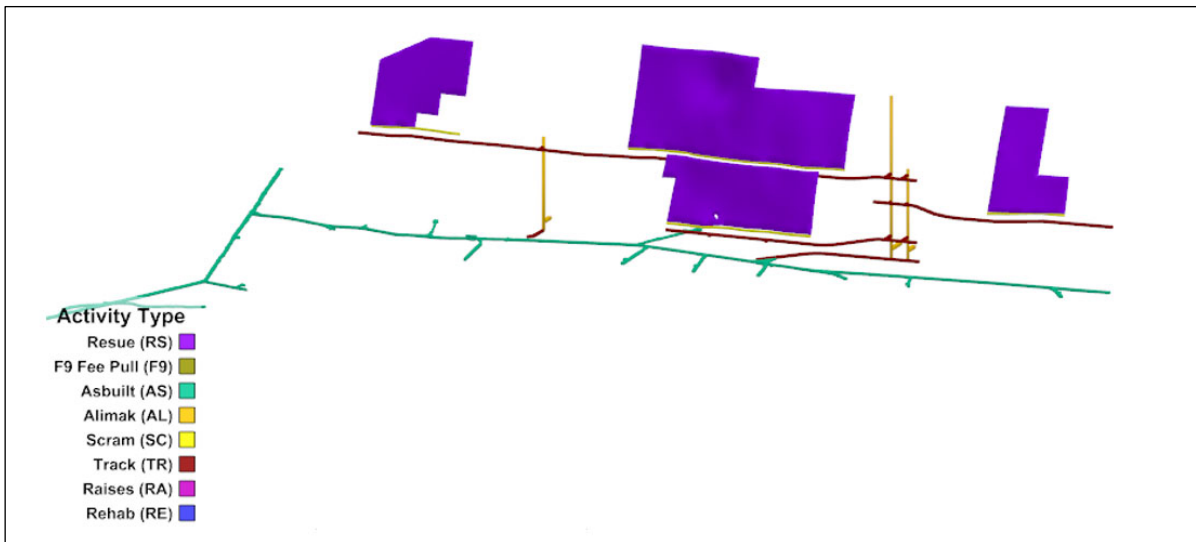

Source: SRK

Figure 16-14: Yellow Rose Area Planned Development (Rotated View- Looking Toward Portal)

Each designed development item was further divided into separate tasks/activities that must occur (i.e., manway, service way, finger raises, etc.) and each line item was tracked in a spreadsheet for incorporation into the production schedule.

Scram development will be 4 ft wide by 8 ft high and is assumed to be mined as waste.

16.3.5 Mine Design

The underground mine design process results in reserves of 577 kst (diluted) with an average grade of 25.38 oz/st Ag, 0.06 oz/st Au, 4.93% Pb, and 2.13% Zn. The overall NSR value for the reserve is US\$643/st. These tonnages and grades include only Proven and Probable material. Figure 16-15, Figure 16-16 and Figure 16-17 show various views of the mine design colored by NSR and width. Note that concentrate grade, recovery and market terms (e.g., payability) assumption used for LoM average NSR calculations may vary somewhat from final assumptions in the economic model, as these assumptions were made prior to the results of the metallurgical and concentrate marketing studies. These changes in the economic model assumptions are not considered material to the mine design process.



Source: SRK

Figure 16-15: Mine Design Colored by NSR – Rotated View Looking Southwest (Looking from the Portal)

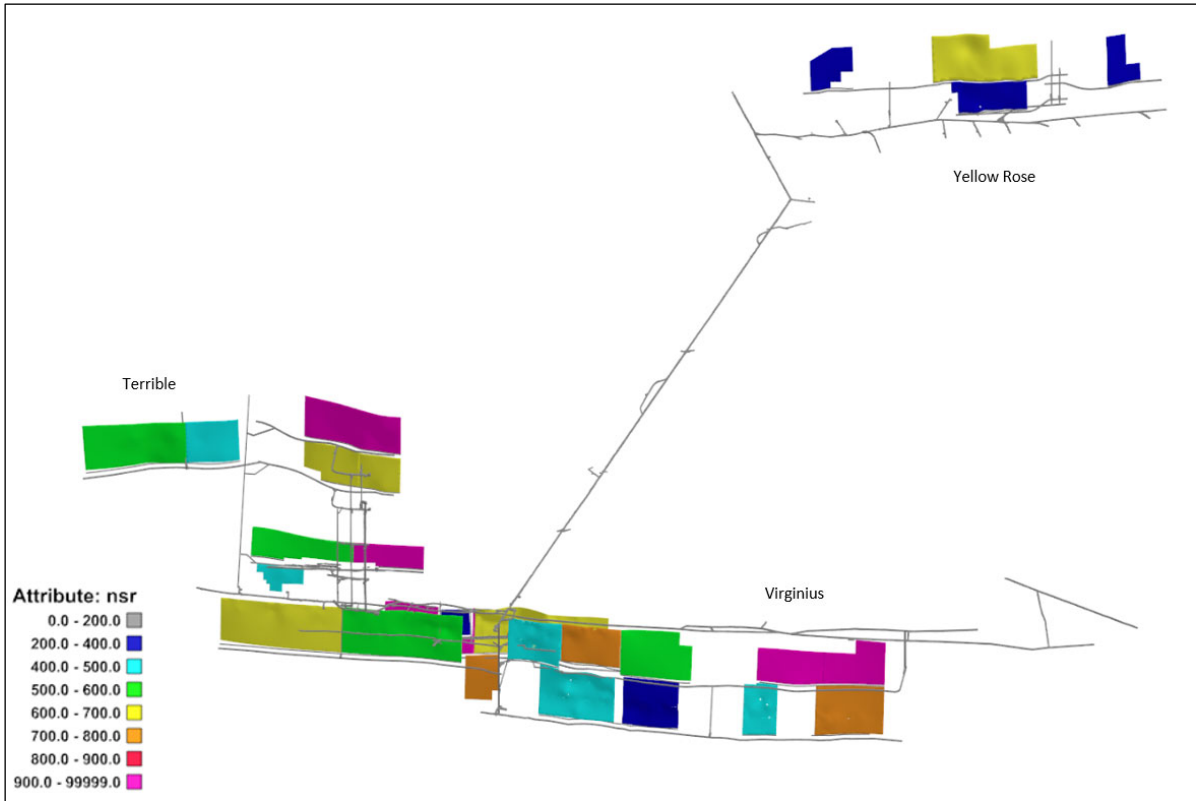

Source: SRK

Figure 16-16: Mine Design Colored by NSR – Rotated View Looking Northeast (Looking Toward the Portal)

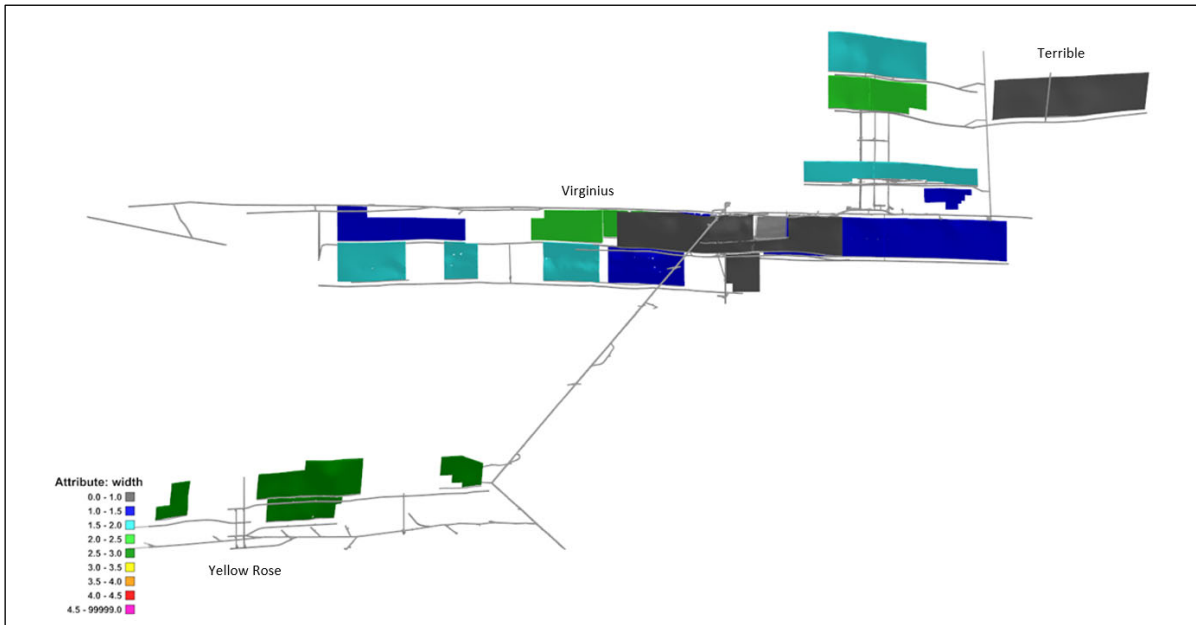

Source: SRK

Figure 16-17: Mine Design Colored by Mining Width – Rotated View Looking Southwest (Looking From the Portal)

16.4 Production Schedule

A monthly production schedule was generated using Excel for each development and stope item. This schedule was created by OSMI and SRK converted the line items and dates into an iGantt schedule to verify the scheduling order, required development and production tonnages/grades by period.

The schedule targeted approximately 8,000 st ore/month (96,000 st/y).

16.4.1 Productivity Assumptions

The production schedule is based on the rate assumptions shown in Table 16-7.

Table 16-7: Productivity Rates

Area	Type	Width 1 (ft)	Width 2 (ft)	Height (ft)	Tonnage per Shift (t)	Advance per Shift (ft)
Resue Stopping					82.5	108
Shrink Free pull					205	
Lateral Development						
	9x9 Track Drift	9.0		9.0	51.5	7.4
	9x9 Track Drift - Jumbo	9.0		9.0	80.5	11.6
	Level Siding	12.0		12.0	73.8	8.0
	Drift Rehabilitation	2.0		2.0	18.5	12.0
	Resue Stope Scram	4.0		4.0	34.0	11.160
	Resue Stope Scram 01	4.0		4.0	25.5	8.4
	Shrink Stope Scram	4.0		4.0	34.3	11.2
	Alimak Raise 3x9 Station Scram	4.0		4.0	19.3	8.4
	Alimak Raise 4x9 Station Scram	3.0		3.0	25.8	8.4
	Alimak Raise 9x9 Station Scram	4.0		4.0	29.0	4.2
	Alimak Raise 10x14 Station Scram	9.0		9.0	95.7	3.4
	Alimak Raise Dog Holes	10.0		10.0	10.0	11.2
	Alimak Standard Nest	3.0		3.0	66.8	4.5
	Alimak Hoist Nest	10.0		10.0	66.8	4.5
	Station Enlargement	12.0		7.0	24.2	3.4
	Shink Cut & Hog Pockets	6.0		8.0	22.9	8.4
Vertical Development						
	Level Dump Raise	6	6		17.2	4.5
	Alimak Muck Raise	4	4		10.2	7.4
	Alimak Standard Raise	6	8		30.5	7.4
	Alimak Hoist Raise	7	12		53.4	7.4
	Alimak Finger Raise	6	6		17.2	5.6
	Alimak Chute Raise	8	8		30.5	5.6
	Carried Manway Raise	6	8		22.9	1.7
	Resue Chute Raise	4	4		7.6	3.9
	Service Manway Raise – Prep Set	6	12		34.3	2.3
	Service Manway – Carry Set 1	6	12		36.9	2.0
	Service Manway – Carry Set 2	6	12		36.9	3.0
	Alimak Box Cut	7	12		53	7.4
	Raise Sump Excavation	12	10		10	1.0
Timbering and Hoists						
	Timbering Standard Raise	8	8			8
	Timbering Hoist Raise	10	14			8
	Timbering Alimak Finger Raise	6	6			8
	Timbering Carried Manway Raise	6	8			8

Area	Type	Width 1 (ft)	Width 2 (ft)	Height (ft)	Tonnage per Shift (t)	Advance per Shift (ft)
	Timbering Service Manway Raise	6	12			8
	Resue Chute Package	4	4			8
	Alimak Chute Package	8	8			8

Source: OSMI/SRK, 2021

The rates are based on actual operating data from the predevelopment period. Where activities have not occurred, first principles estimates were used with supporting confirmation by test stope work and operating experience. SRK notes that productivity rates have been derated prior to full access to the production zone when the #1 Alimak hoist is installed to move men and materials effectively.

The mining operation schedule is based on 337 days/year, 7 days/week, with two 10 hr shifts each day.

16.4.2 Monthly Production Schedule

A monthly production schedule was generated for the life of the mine based on these productivities. The monthly detail was necessary for the development/ramp up definition and as the mine life was 6 years, the schedule and economic model continued monthly. Later years will require more detailed sequencing as mining progresses. There is an 8-month development period, followed by a 3-month mill ramp up period before full production is achieved. The economic model assumes month 1 is January 1, 2022.

During the pre-production and early period, the following activities take place:

- The key critical path activity is to complete steel, timber hoist installation at Alimak #1 (performed by contract) to allow production level access to the stopes above the Virginius level (2000 level).
- Installation of sump, backup generation, substation, and elevator system at the Hubb-Reed borehole raise will be performed by Century Elevator
- Work will begin on rehabilitation and timbering the #1 Shaft but will continue after the pre-production and ramp up. This work will be contracted.
- Driving #2, and #3 Alimaks as muck passes to the 1200, and 900 levels
- Develop and complete dump packets and scam stations on the 1200 and 900 levels
- Stope development work on the 1200 and 1800 levels
- 1200 and 1800 level track work and development drifting work to connect with muck passes, Alimak #1 and ventilation borehole (Hubb-Reed Raise)
- Driving drift to the south on the 2000 level on the footwall

Future development will include:

- Complete #1 Shaft rehab and installation of hoist system to access lower mine levels
- Development of the lower levels of mine
- Yellow Rose area development begins in period 31 (July 2024) and ore material is not scheduled until period 58 (October 2026)

Table 16-8 shows the mine production schedule by period.

Table 16-8: Monthly Mining Schedule

Time Period (Month-Yr)	Period (mo's)	Waste Tons (st)	Ore Tons (st)	Ag opt	Au opt	Cu (%)	Pb (%)	Zn (%)
Jan-22	1	-	-	-	-	-	-	-
Feb-22	2	-	-	-	-	-	-	-
Mar-22	3	-	-	-	-	-	-	-
Apr-22	4	3,329	-	-	-	-	-	-
May-22	5	3,613	-	-	-	-	-	-
Jun-22	6	4,724	-	-	-	-	-	-
Jul-22	7	5,813	-	-	-	-	-	-
Aug-22	8	7,563	-	-	-	-	-	-
Sep-22	9	6,558	1,918	20.70	0.05	0.15	4.34	5.44
Oct-22	10	5,621	3,596	20.70	0.05	0.15	4.34	5.44
Nov-22	11	2,489	5,319	30.06	0.05	0.26	6.17	4.22
Dec-22	12	2,638	6,573	34.84	0.06	0.32	7.10	3.61
Jan-23	13	2,584	6,573	34.84	0.06	0.32	7.10	3.61
Feb-23	14	2,638	6,573	34.84	0.06	0.32	7.10	3.61
Mar-23	15	2,638	6,645	35.22	0.06	0.33	7.00	3.37
Apr-23	16	3,769	7,668	30.84	0.06	0.32	5.13	3.38
May-23	17	5,710	7,914	25.85	0.06	0.30	3.81	4.11
Jun-23	18	7,319	7,914	25.85	0.06	0.30	3.81	4.11
Jul-23	19	7,996	7,914	25.85	0.06	0.30	3.81	4.11
Aug-23	20	7,831	7,914	25.85	0.06	0.30	3.81	4.11
Sep-23	21	5,748	8,090	25.93	0.06	0.31	5.45	2.75
Oct-23	22	8,037	8,260	36.55	0.07	0.36	6.14	2.38
Nov-23	23	7,846	8,266	36.91	0.07	0.36	6.16	2.37
Dec-23	24	2,295	7,715	36.91	0.07	0.36	6.16	2.37
Jan-24	25	2,294	7,715	36.91	0.07	0.36	6.16	2.37
Feb-24	26	2,477	7,715	44.36	0.09	0.20	5.28	1.44
Mar-24	27	2,549	7,715	45.25	0.09	0.18	5.17	1.33
Apr-24	28	3,227	8,266	45.25	0.09	0.18	5.17	1.33
May-24	29	3,227	8,266	43.50	0.11	0.20	8.50	1.52
Jun-24	30	3,094	8,266	42.60	0.11	0.19	8.95	1.51
Jul-24	31	7,601	8,266	29.96	0.11	0.09	9.17	0.94
Aug-24	32	5,927	8,266	28.84	0.10	0.10	8.71	0.98
Sep-24	33	6,205	8,266	18.72	0.07	0.19	4.51	1.29
Oct-24	34	6,000	8,266	18.72	0.07	0.19	4.51	1.29
Nov-24	35	2,359	8,266	18.72	0.07	0.19	4.51	1.29
Dec-24	36	2,226	7,715	23.46	0.05	0.29	5.59	1.53
Jan-25	37	2,092	7,715	24.49	0.05	0.31	5.82	1.58
Feb-25	38	2,823	7,715	24.49	0.05	0.31	5.82	1.58
Mar-25	39	3,257	7,715	30.02	0.04	0.41	5.86	1.69
Apr-25	40	3,366	8,266	35.55	0.04	0.52	5.90	1.80
May-25	41	2,924	8,266	35.08	0.04	0.42	5.20	1.67
Jun-25	42	5,753	8,266	31.46	0.04	0.33	4.72	1.74
Jul-25	43	5,692	8,266	24.07	0.04	0.23	4.31	2.01
Aug-25	44	3,920	8,266	24.07	0.04	0.23	4.31	2.01
Sep-25	45	2,559	8,266	24.07	0.04	0.23	4.31	2.01
Oct-25	46	2,582	8,266	24.07	0.04	0.23	4.31	2.01
Nov-25	47	3,905	8,266	24.07	0.04	0.23	4.31	2.01
Dec-25	48	1,282	7,715	24.07	0.04	0.23	4.31	2.01
Jan-26	49	1,969	7,715	24.07	0.04	0.23	4.31	2.01
Feb-26	50	3,668	7,715	24.07	0.04	0.23	4.31	2.01
Mar-26	51	3,863	7,715	27.53	0.06	0.29	5.39	2.31
Apr-26	52	2,581	8,266	28.83	0.06	0.30	5.80	2.36
May-26	53	2,227	8,266	24.45	0.07	0.31	4.82	2.03
Jun-26	54	1,027	8,266	21.72	0.07	0.32	4.21	1.82
Jul-26	55	420	8,266	21.72	0.07	0.32	4.21	1.82

Time Period (Month-Yr)	Period (mo's)	Waste Tons (st)	Ore Tons (st)	Ag opt	Au opt	Cu (%)	Pb (%)	Zn (%)
Aug-26	56	1,327	8,266	21.72	0.07	0.32	4.21	1.82
Sep-26	57	1,494	8,266	21.72	0.07	0.32	4.21	1.82
Oct-26	58	1,614	8,266	20.80	0.05	0.26	4.72	1.92
Nov-26	59	2,456	8,266	20.57	0.05	0.17	4.35	2.26
Dec-26	60	3,863	7,715	20.67	0.04	0.15	4.08	2.39
Jan-27	61	1,567	7,715	20.67	0.04	0.15	4.08	2.39
Feb-27	62	2,249	7,715	20.67	0.04	0.15	4.08	2.39
Mar-27	63	3,207	7,715	20.67	0.04	0.15	4.08	2.39
Apr-27	64	1,432	8,266	20.67	0.04	0.15	4.08	2.39
May-27	65	1,005	8,266	20.13	0.07	0.22	4.43	2.52
Jun-27	66	158	8,266	19.96	0.07	0.24	4.55	2.56
Jul-27	67	-	8,266	19.96	0.07	0.24	4.55	2.56
Aug-27	68	-	8,266	22.15	0.05	0.21	5.34	2.32
Sep-27	69	-	8,266	23.42	0.04	0.19	5.80	2.19
Oct-27	70	-	8,266	23.42	0.04	0.19	5.80	2.19
Nov-27	71	-	8,266	17.07	0.06	0.13	7.91	1.21
Dec-27	72	-	7,715	16.97	0.06	0.13	7.95	1.20
Jan-28	73	-	7,715	18.08	0.04	0.15	4.87	1.50
Feb-28	74	-	7,715	18.35	0.03	0.16	3.76	1.60
Mar-28	75	-	7,715	15.60	0.04	0.16	1.61	1.32
Apr-28	76	-	8,266	15.60	0.04	0.16	1.61	1.32
May-28	77	-	8,266	14.30	0.05	0.18	1.88	1.52
Jun-28	78	-	8,266	12.91	0.05	0.20	2.17	1.73
Jul-28	79	-	6,742	13.05	0.05	0.20	2.42	1.93
Aug-28	80	-	7,358	13.96	0.05	0.21	2.49	1.80
Sep-28	81	-	7,358	13.96	0.05	0.21	2.49	1.80
Oct-28	82	-	5,794	16.07	0.04	0.22	2.24	1.36
Nov-28	83	-	5,020	18.70	0.02	0.26	2.10	0.69
Totals		230,231	576,997	25.38	0.06	0.25	4.93	2.13

Source: OSMI/SRK, 2022

Total Ore tons listed here vary somewhat from the reserves stated in Table 15-6 due to rounding.

Figure 16-18 shows the production schedule colored by period.

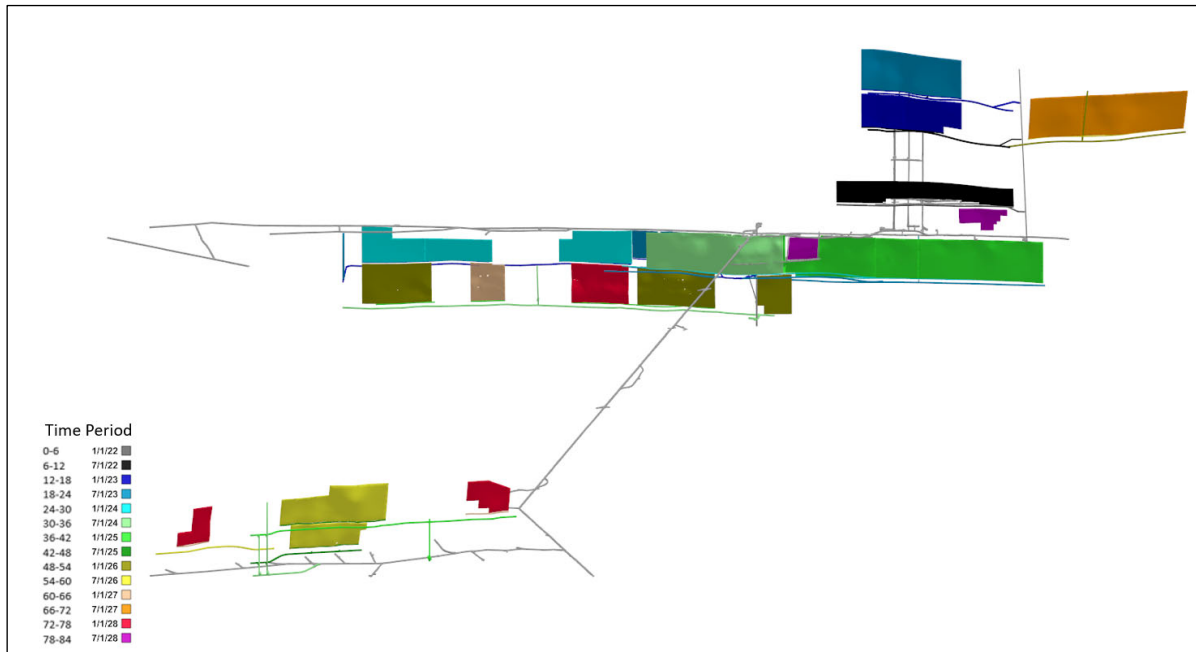

Source: SRK, 2022

Figure 16-18: Mine Production Schedule, Colored by Time-Period - Rotated View Looking Southwest (Looking from the Portal)

16.5 Mining Operations

All new stopes are mined using the rescue mining method. The mining widths are narrow and average approximately 1.5 ft in the Virginius and Terrible areas, and 2.5 ft in the Yellow Rose area. Stope development begins with construction of 2, two-compartment manway raises on each end and a three-compartment service raise in the approximate center. These are carried raises that advance with the stope vertically and completed with air, water and ventilation. These raises are driven to allow men and materials into the stope. Once the manways and service raises are driven, rescue raises are developed to allow ore from the raise to be slushed to a chute for loading into rail cars. Once all the raises are completed a 4 ft wide x 8 ft high scram is driven at the top of the service raise out each direction on vein to connect with each rescue raise as well as the manways on each end. Once the scram is completed each raise is timbered appropriately with chute packages on each rescue raise as well as on the ore compartment of the service raise. At haulage level, the chutes allow mineralized material to be loaded into muck cars and trammed by battery-electric or diesel locomotive out of the mine.

Stope mining then commences with 6 ft upholes drilled from the scram. Ore and waste material are blasted separately to minimize dilution. Ore is slushed from the stope whereas waste is left in situ and serves as a working platform for the next vertical cut. In certain areas, additional waste will need to be blasted from the footwall to provide enough material for filling the stope. It is expected that slushing excess waste from narrower areas to wider areas should reduce the amount of additional footwall waste to be blasted.

The mine will use primarily pneumatic equipment and currently has only one 7-ton main haulage battery locomotive underground and OSMI has purchasing a second locomotive for haulage on the main track area from the shaft to the mill or portal. All other locomotives including 8-ton, 4-ton and 2-ton Mancha motors are electric and will be used for men, materials and off main level haulage. In most areas, OSMI intends to make use of existing mine track and tracked mining equipment such as battery-powered locomotives, muck cars, and Eimco 22B and 12B overshot mucking machines. Production and development will be performed with jackleg drills and stopers, with primarily air slushers in the stopes for transfer of ore to rescue ore chutes.

The mine will use standard 24-inch gauge and 4-ton muck cars (5 tons heaped), with seven to eight cars per train. Typical rail haulage cycle time is approximately one hour, and mine personnel are able to cycle nine trains per shift. There are suppliers of track mining equipment and the company currently used is Mining Equipment Limited and Melcher Fabrication both located in Durango, Colorado, approximately 79 miles from the mine site.

Approximately three to four working stopes are required to meet the production target of 270 st/d. A single stope provides two working faces for production of ore. Having two stopes fully operational provides four working faces required to meet the production target. Typically, a third stope will be nearly fully developed to provide a fifth face for a contingency if any of the four planned faces have issues. Normally there will be at least two stopes in various stages of development and scheduled into the mining cycle to account for delays and transitions between the main production stopes.

16.5.1 Rehabilitation of Historic Workings

There are substantial existing workings available for use during the mining operations. These include workings above the main track level and below the track level in the Virginus area of the mine. OSMI has currently rehabbed the main Revenue Tunnel level to the borehole area on the north side of the Revenue areas. The Yellow Rose is currently rehabbed to the base of the older raise systems established in the last mining campaign in 2015.

The rehabilitation on the main access 2000 level from the portal to the mine vent borehole was completed in the 2020-2021 development activities. Future rehabilitation plans will include the 2210, 2350, 2550, and 2700 levels. The rehabilitation will include ground support, rail replacement/repair, drift clean-up, replacement or addition of utilities (air, water, pump discharge, communications) as needed.

16.5.2 Rescue Mining

Each rescue mining team is generally made up of 5 miners (1 miner I, 2 miner II's, and 2 miner III's). Two 5 person teams will each mine one stope on every shift. The crew will perform the selective mining of the ore with stopers, and air slushers used to remove the ore. The team will mine from the one end of the 500 ft or longer stope toward the other allowing a reasonable slushing distance between rescue raises (muck passes) to be in a different portion of the mining cycle (drilling, ore blasting, slushing, cribbing and waste blasting). As a section of the stope reaches the waste blasting portion of the cycle each raise (manway, service or rescue muck pass) will be cribbed up and covered. After waste is blasted and potentially leveled with a slusher, the raises will be put back into use for the next portion of the mining cycle.

Blasting will primarily use ANFO AP emulsion that will be placed with the primers into the holes. The primer system is non-electric (non-el). Central blasting is being evaluated for stope mining as blasting in the stope will only be allowed at end of shift. Where needed, alternative powder will be used.

Ground support will be installed on an as needed basis including split set bolts, mats, and/or wire mesh. The current rock characteristics and small openings of the mining method indicate that only spot ground support will be required in stopes. The slushing operation for ore will occur over distances typically not exceeding 80 ft. Once the ore is placed in the ore pass, the muck travels down the ore pass through the finger raise where it rests against the chute door until the muck crew opens the pneumatically operated chute door to load the rail cars. The rail cars transfer ore either to loading pockets on the lower mine levels for hoisting to the 2000 level and final haulage to the mill, directly to the mill on the 2000 level, or in stopes above the 2000 level to a transfer ore pass down to the 2000 level. Approximately two stopes will typically be in operation, with one to two others in various stages of development. Ventilation, water supply, compressed air supply, electrical supply, and communications are provided at each manway and service raise in each stope to allow miners to pull their utilities from the shortest location.

Alimak raises will be located at strategic locations in the mine to allow for movement of men and materials in areas 300 ft or more above the level below it.

16.5.3 Waste Rock

Waste rock is only created during rehabilitation or development in the current LoM plan. The waste rock is drilled and blasted in a conventional manner and then mucked with a rail type overshot mucker feeding a rail-mounted car. The cars are individually loaded and then placed into groups of seven cars and hauled to the surface or backfilled into shrinkage stopes or old workings where available. Typically, the waste rock is moved to the surface where it is crushed and used for road base or combined, per permit, with the tailings. The current mine plan has a total of 230 kst of waste over the LoM. The waste rock averages about 2,770 st/m over the LoM. Waste rock is typically 36% of the total material moved per day.

16.6 Mine Equipment, Key Materials and Projects

16.6.1 Mine Equipment and Key Materials

The underground existing equipment is summarized in Table 16-9. The majority of the equipment is air powered and not affected by altitude. Where applicable, diesel equipment is derated due to altitude.

Table 16-9: Mining Equipment List

Name	Description	Equipment Type
Locomotives		
L2 - 1	1.5 Ton Goodman Mancha	Locomotive
L2 - 2	1.5 Ton Goodman Mancha	Locomotive
L2 - 3	1.5 Ton Goodman Mancha	Locomotive
L4 - 1	4 Ton Goodman Loci	Locomotive
L4 - 2	4 Ton Goodman Loci	Locomotive
L4 - 3	4 Ton Goodman Loci	Locomotive
L4 - 4	4 Ton Atlas Loci	Locomotive
L4 - 5	4 Ton Greensburg Loci	Locomotive
L4 - 6	4 Ton Greensburg Loci	Locomotive
L8 - 1	8 Ton Greensburg Loci	Locomotive
L8 - 2	8 Ton Greensburg Loci	Locomotive

Name	Description	Equipment Type
L8 - 3	8 Ton Greensburg Loci	Locomotive
L8 - 4	8 Ton Greensburg Loci	Locomotive
Overshot Muckers		
M12 - 1	Eimco 12B	Mucker
M12 - 2	Eimco 12B	Mucker
M12 - 3	Eimco 12B	Mucker
M12 - 4	Eimco 12B	Mucker
M12 - 5	Eimco 12B	Mucker
M12 - 6	Eimco 12B	Mucker
M21 - 1	Eimco 21 Mucker	Mucker
M21 - 2	Eimco 21 Mucker	Mucker
M22 - 1		Mucker
M22 - 2	Eimco 22 Mucker	Mucker
M22 - 3	Eimco 22 Mucker	Mucker
M22 - 4	Eimco 22 Mucker	Mucker
M22 - 5	Eimco 22 Mucker	Mucker
M310 - 1	Atlas Copco 310 Cavo	
Mine Equipment		
YB-1 7 Ton Young Buggy		
U17 Kubota Excavator		Excavator
634 Track Mucker	The Beast	Track Mucker
Tuggers/Slushers		
T20 - 1	Ingersoll Rand 20HP Tugger	Tugger/Slusher
T20 - 2	Ingersoll Rand 20HP Tugger	Tugger/Slusher
T20 - 3	Ingersoll Rand 20HP Tugger	Tugger/Slusher
T20 - 4	Ingersoll Rand 20HP Tugger	Tugger/Slusher
T30 - 1	Ingersoll Rand 30HP Air tugger	Tugger/Slusher
T30 - 2	Ingersoll Rand 30HP Wide Drum	Tugger/Slusher
S10 - 1	Gardner Denver 10HP Slusher	Tugger/Slusher
S20 - 1	Ingersoll Rand 20HP Slusher	Tugger/Slusher
S20 - 2	Ingersoll Rand 20HP Slusher	Tugger/Slusher
S20 - 3	Ingersoll Rand 20HP Slusher	Tugger/Slusher
S20 - 4	Ingersoll Rand 20HP Slusher	Tugger/Slusher
S20 - 5	Ingersoll Rand 20HP Slusher	Tugger/Slusher
S20 - 64	Ingersoll Rand 20HP Slusher	Tugger/Slusher
S30 - 1	Joy FF211 30HP Slusher	Tugger/Slusher
S30 - 2	Joy FF211 30HP Slusher	Tugger/Slusher
S10 - 1	Trident M#S211 Air Slusher and Buckets	Tugger/Slusher
S10 - 2	Trident M#S211 Air Slusher and Buckets	Tugger/Slusher
S10 - 3	Trident M#S211 Air Slusher and Buckets	Tugger/Slusher
S10 - 4	Trident M#S211 Air Slusher and Buckets	Tugger/Slusher
S10 - 5	Trident M#S211 Air Slusher and Buckets	Tugger/Slusher
S10 - 6	Trident M#S211 Air Slusher and Buckets	Tugger/Slusher
S10 - 7	Trident M#S211 Air Slusher and Buckets	Tugger/Slusher
S10 - 8	Trident M#S211 Air Slusher and Buckets	Tugger/Slusher
S10 - 9	Trident M#S211 Air Slusher and Buckets	Tugger/Slusher
S10 - 10	Trident M#S211 Air Slusher and Buckets	Tugger/Slusher
Pumps/Machines		
SM - 1	Reed Shotcrete Machine	
SM - 2	Reed Shotcrete Machine	
GP-1 Grout Pump	Grout Pump	
GP-2 ChemGrout Grout Pump	ChemGrout Pressure Grout Pump	
BP - 1	FMC Bean Pump	Ditch Water Pump
BP - 2	FMC Bean Pump	Ditch Water Pump
BP - 3	FMC Bean Pump	Ditch Water Pump
BP - 4	FMC Bean Pump	Ditch Water Pump
BP - 5	FMC Bean Pump	Ditch Water Pump

Name	Description	Equipment Type
Climbers		
RC - 1 Alimak Climber Unit	Raise Climber	
RC - 2 Alimak Climber Unit	Raise Climber	
RC - 3 Alimak Climber Unit	Raise Climber	
Surface Equipment		
Loaders		
HE001 CAT 950G Loader	950G	Loader
HE002 CAT IT38H	IT-38H	Loader
HE003 CAT 259B3 Skid Steer	259B3	Skid Steer
HE004 CAR 242D Skid Steer	242D	Skid Steer
Haul Trucks		
HE005 CAT 725 Truck	725 Truck	Haul Truck
HE006 CAT 725 Truck	725 Truck	Haul Truck
Excavators		
HE007 CAT 320C	CAT 320C	Excavator
HE008 CAT 325D	CAT 325D	Excavator
Telehandlers		
HE009 CAT TH580B	TH580B	Telehandler
HE010 CAT TH560B	TH560B	Telehandler
Manlifts		
HE011 Genie Manlift	Genie	Manlift
HE012 JLG 600AJ Manlift	JLG 600AJ	Manlift
Sand Truck		
	Ford F350	Road Truck
Compactor		
HE013 CAT CS-433E Vib Single Drum	Single Drum	Compactor
Dozer		
HE014 CAT D5K2 LGP	Dozer	Dozer
Compressors		
CP001 Ingersoll Rand EP 200HP	200HP Rand EP	Compressor
CP002 Ingersoll Rand EPE 250HP	250HP Rand EPE	Compressor
CP003 Ingersoll Rand EPE 300HP	300HP Rand EPE	Compressor
Flat Cars		
LB - 1	12.5 Ton Low Boy Car	Flat
LB - 2	Low Boy Segment Car	Flat
TTC - 1	Pair Tandem Timber Trucks	Flat
FC - 1	4' x 8' Flat Cars	Flat
FC - 2	4' x 8' Flat Cars	Flat
FC - 3	4' x 8' Flat Cars	Flat
FC - 4	4' x 8' Flat Cars	Flat
FC - 5	4' x 8' Flat Cars	Flat
FC - 6	4' x 8' Flat Cars	Flat
FC - 7	4' x 8' Flat Cars	Flat
FC - 8	4' x 8' Flat Cars	Flat
FC - 9	4' x 8' Flat Cars	Flat
FC - 10	3.6 x 4' Flat Cars	Flat
FC - 11	3.6 x 4' Flat Cars	Flat
FC - 12	3.6 x 4' Flat Cars	Flat
FC - 13	3.6 x 4' Flat Cars	Flat
BC - 1	Ballast Car	Flat
TC - 1	Torch Car	Flat
EC - 1	Explosives Car	Flat
PC - 1	Aux Powder Box Car	Flat
Ore Cars		

Name	Description	Equipment Type
MC - 1	4 Ton Granby Muck Car	Muck Car
MC - 2	4 Ton Granby Muck Car	Muck Car
MC - 3	4 Ton Granby Muck Car	Muck Car
MC - 4	4 Ton Granby Muck Car	Muck Car
MC - 5	4 Ton Granby Muck Car	Muck Car
MC - 6	4 Ton Granby Muck Car	Muck Car
MC - 7	4 Ton Granby Muck Car	Muck Car
MC - 8	4 Ton Granby Muck Car	Muck Car
MC - 9	4 Ton Granby Muck Car	Muck Car
MC - 10	4 Ton Granby Muck Car	Muck Car
MC - 11	4 Ton Granby Muck Car	Muck Car
MC - 12	4 Ton Granby Muck Car	Muck Car
MC - 13	4 Ton Granby Muck Car	Muck Car
MC - 14	4 Ton Granby Muck Car	Muck Car
MC - 15	4 Ton Granby Muck Car	Muck Car
MC - 16	4 Ton Granby Muck Car	Muck Car
MC - 17	4 Ton Granby Muck Car	Muck Car
MC - 18	4 Ton Granby Muck Car	Muck Car
MC - 19	4 Ton Granby Muck Car	Muck Car
MC - 20	4 Ton Granby Muck Car	Muck Car
MC - 21	4 Ton Granby Muck Car	Muck Car
MC - 22	4 Ton Granby Muck Car	Muck Car
MC - 23	4 Ton Granby Muck Car	Muck Car
MC - 24	4 Ton Granby Muck Car	Muck Car
MC - 25	4 Ton Granby Muck Car	Muck Car
MC - 26	4 Ton Granby Muck Car	Muck Car
MC - 27	4 Ton Granby Muck Car	Muck Car
MC - 28	4 Ton Granby Muck Car	Muck Car
MT - 1	Man Trip	Man Trip
MT - 2	Man Trip	Man Trip
RD - 1	2 Ton C.S Card Rocker Dump	Rocker Dump
RD - 2	2 Ton C.S Card Rocker Dump	Rocker Dump

Source: OSMI, 2021

16.6.2 Projects

The key remaining underground projects, to be completed during the next period prior to production period are included in Table 16-10.

Table 16-10: Key Mine Projects (Costs Provided in OSMI Budget)

Area	Unit Cost (US\$000's)
Alimak #1 Timber and Hoist Install, Steel sets Fab, Hoist design and hoist materials	1,200
Century Elevator Hub-Reed Elevator/backup generator project	325
Miscellaneous (Air Door, Alimak items, Diamond Drill, Central water system)	608
Total	2,133

Source: OSMI 2021

The #1 shaft rehab is described in Section 16.8.1.

16.7 Ventilation

The LoM design and production areas for the Revenue-Virginius Mine used for the ventilation work are shown in Figure 16-19. The mine is developed from the existing Revenue Tunnel in an area containing historical workings. There will be one set of working areas located near the existing portal

called the Yellow Rose that will initially be developed with auxiliary ventilation until its own exhaust raise is developed and extends to surface. Additional workings will be developed at the end of the Revenue Tunnel to the north and south of the tunnel. The primary exhaust for these workings will be through an existing/rehabilitated raise bore that extends from the Revenue Tunnel Level (2000 Level) to surface and is equipped with an Alimak. Because of the topography at the surface and lack of convenient access, the main exhaust fan will be located at the base of the exhaust raise bore underground. This necessitates the use of exhaust fans on the levels above the Revenue Tunnel Level (1800, 1200, 900, 600 levels) that break into the Exhaust Raisebore, these small level fans will be operated in parallel with the main exhaust fan.

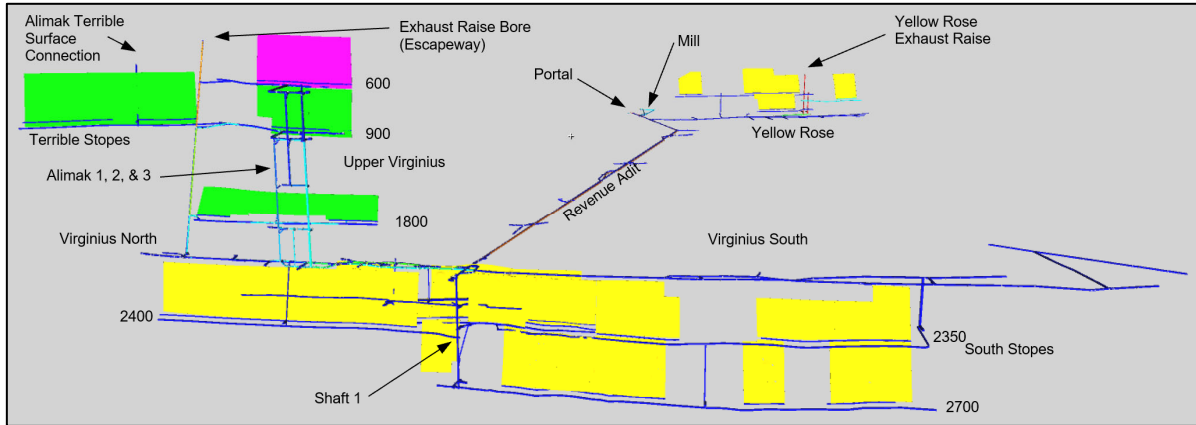

Source: SRK, 2022

Figure 16-19: Overall Ventilation Layout Including Stopes and Development

In the past the mine has been ventilated through the use of “natural ventilation pressure” or the air heater fan currently installed on the Revenue Adit portal. The reliance on natural ventilation pressure should be avoided so that the ventilation system can be supplied in a consistent and controlled manner. In order to ventilate both the Yellow Rose and the Virginius areas natural ventilation pressure cannot be relied upon.

16.7.1 Airflow Requirements

Site engineers provided SRK with an approximate schedule of development and production. Currently no diesel equipment is planned for use in this mine. Airflow will be based on maintaining adequate air velocity for cooling and dust dilution, airflow distribution for bleed points, and leakage. Additional airflow will be required to ventilate the stopes, ensure against recirculation, and to allow the simultaneous production in both the Revenue-Virginias mining area and in the Yellow Rose.

The airflow through the stopes is based upon maintaining a minimum air velocity of 100 ft/min across the stope and access. The value of 100 ft/min represents an air velocity slightly above perceptible air movement (60 ft/min) and will aid in clearing blast fumes and fugitive dust accumulations.

Table 16-11: Minimum Total Mine Airflow Requirements (Excluding Leakage)

	Quantity	Power (hp)	Area (ft ²)	Factor	Airflow (kcfm)
Locomotive					
Locomotive – Electric	1				n/a
Working Area					
Stope	2	N/A	24	Velocity	4.8
Access	2	N/A	60	Velocity	12.0
Stope Development (level)	1	N/A	81	Velocity	4.7-8.1
Development (Track)	2	N/A	60	Velocity	12.0
Additional Development Area					
Access Development	1	N/A	60	Velocity	12.0
Total					49.2

Source: SRK, 2022

The value of approximately 49.2 kcfm represents a general airflow requirement and excludes any allowance for leakage. The actual airflow required for the mine is developed through the process of airpath network modeling. The application of the airflow for each area can be more thoroughly identified with the use of ventilation network modeling. This would include the leakage through the ore/waste pass system. It is important to note that production will not occur in just one area, rather there will be multiple development and production fronts staged across the mine.

16.7.2 Recommended Air Velocities and Airflow Limitations

A ventilation network can be established for nearly any mine configuration, but the desired airflow results cannot always be achieved without exceeding the limits of practical ventilation application. The main limit for this ventilation system will be the air velocity through the Revenue Adit. An air velocity of between 800 ft/min and 1,000 ft/min should be placed on the Revenue Adit. This relates to an airflow range of 72 kcfm to 90 kcfm. The length of tunnel between the Mill Access and the Portal will experience the highest air velocity depending upon the configuration of the Mill (intaking or exhausting).

The 8 ft dia. exhaust raise bore located at the end of Virginius North in the Revenue area will be used as an escapeway and will incorporate an Alimak type conveyance system. The velocity of the airflow through this area should be limited to allow for safe egress. A value of approximately 1,000 ft/min was selected for this raise allowing for an airflow of approximately 50.3 kcfm for the Virginius and Terrible Veins. A higher airflow/air velocity can be achieved; however, the fan will need to be turned down prior to personnel access. This required that the 50 hp Minetek 2-122435W Main Exhaust Fan be adjusted down to 15 kcfm while the other upper-level exhaust fans are operating. However, as the upper levels are finished airflow can be transferred to the other working areas and the main exhaust fan operation increased. The benefit of the Minetek fan is that it allows easy inflight control and modulation of airflow.

16.7.3 Alimak Ventilation

It is assumed that the Alimak raises are ventilated by compressed air and that the mine compressor system has the capacity to provide air for both the jacklegs, Alimak motor, and ventilation.

16.7.4 General Stope Ventilation

The stopes will remain open once they are established. This will allow a flow through ventilation system across the stope. The airflow through the stope will be determined by maintaining a minimum air

velocity. The use of a minimum air velocity criteria will allow for both cooling of workers in the stopes, removal of blast fumes, and reducing the humidity in the stopes.

16.7.5 General Mining Areas and Sequence

The mining areas will not be developed and brought into production simultaneously, rather, they will be sequenced through the life of mine. Initial mining will occur in the Upper Virginius, then transition through the Lower Virginius South, then Lower Virginius North, Yellow Rose, and then remnant mining between Yellow Rose, Virginius, and Terrible. There will be transition periods where mining will occur simultaneously in two areas, but then number of active stopes will remain constant.

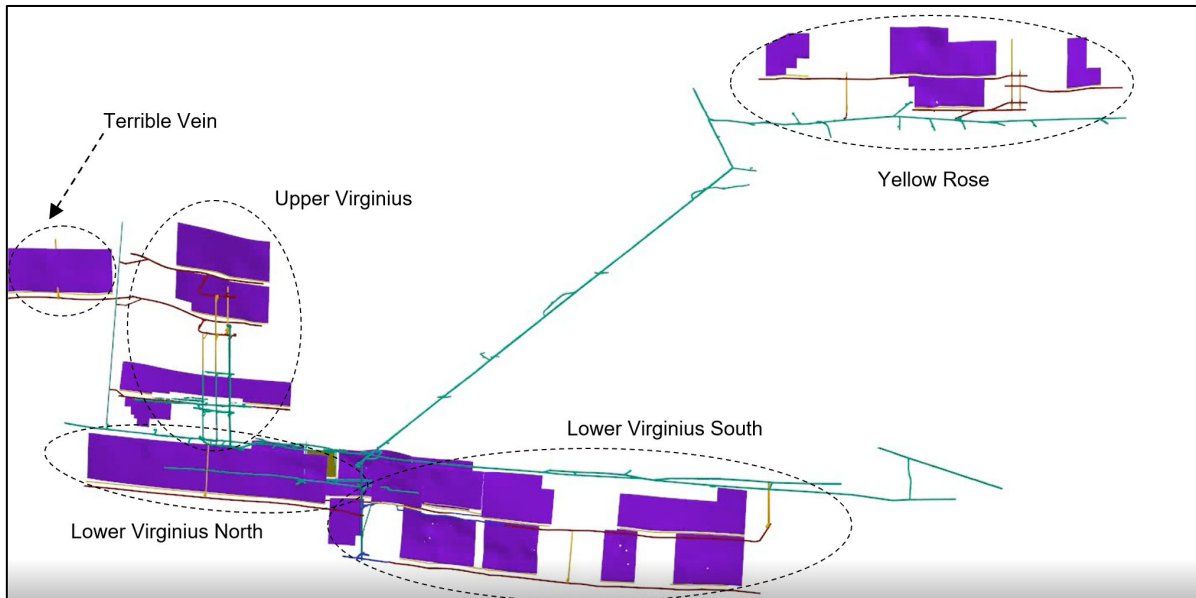

Source: SRK, 2022

Figure 16-20: Mining Areas Developed for Ventilation

16.7.6 Ventilation Model Development

Ventilation models were developed using both the VnetPC and VentSIM simulation software to establish the overall ventilation fan and leakage requirements

Mine Resistances

The resistance values for the branches in each ventilation model were calculated using k-factors drawn from data gathered under similar conditions for the entries and based on the drift dimensions and airway type. Shock losses at bends, inlets, and exhausts were accounted for by adding appropriate shock loss factors to the airway resistances where necessary. A list of the various friction factors used in the creation of the models in this study is provided in Table 16-12. These friction factors are provided at mine density (approximately 0.052 lb/ft³).

Table 16-12: Airway Friction Factors

Airway Type	Friction Factor (lbf min ² /ft ⁴ x10 ⁻¹⁰)	Approximate Dimensions (ft)
Revenue Adit ¹	45	89.7 ft ² (existing)
Scram/Stope Level Development	75	3 x 8
	65	9 x 9
Bored raise ¹	55	8 (existing)
Access Raise	125	6 x 6 and 7 x 12
General Stope Raise	125	6 x 8
Winze Raise (to be rehabilitated)	80	10 x 14

Source: SRK, 2022

¹ Friction factors measured during the 2015 site visit

Leakage branches were added to represent areas with bulkheads and were given a resistance of approximately 100 PU. This assumes the bulkheads are well made.

Main Exhaust Fan Location

The main exhaust fan for the modeling simulation assumed the existing 50 hp Minetek located at the bottom of the Esc/Exh Raise in the connection to Virginius North (2,000 Level) as shown on Figure 16-21. This fan should be capable of achieving the fan duties required to support mining in the Virginius area

For the mine to operate and support the current elevated production, this new exhaust fan will be required. The existing Hurley “heater” fan, although useful, is/was only a stop gap installation. Previously there was an airlock located along the main Revenue Drift that was used to support a set of “main” fans installed in ducts that provided the necessary ventilation pressure, however, this type of installation provides for a significant obstruction in the haulage route (similarly to the installation of a forcing fan located outside of the Revenue Adit portal). Installing the Minetek fan at the base of the raise would be more complicated in that all levels joining into the exhaust raise would need to have a small “level” booster fan installed to operate in parallel with the Minetek fan. Backflow dampers would be required to be installed so that when one of the level fans is turned off airflow would not be recirculated across the level and through the upper mining zone.

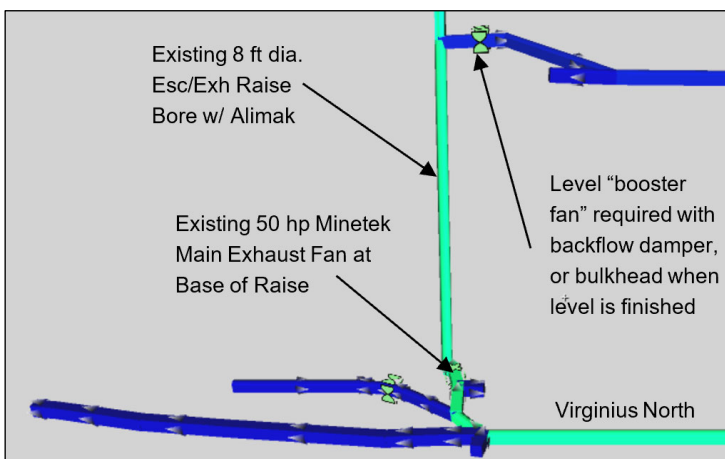

Source: SRK, 2022

Figure 16-21: Main Exhaust Fan Installation Location

The use of the Minetek fan at the bottom of the exhaust raise allows for maximum flexibility. The Minetek fan can be easily adjusted to achieve different operating points. If the Yellow Rose exhaust fan is operated or if the level exhaust fans in the upper mining levels are on-line then the performance of the Mintek fan can be reduced to compensate and provide a proper balance., The location of the exhaust fan at the end of the Virginius North 2000 Level allows for the direct exhaust of dust from the Alimak loadout and blasting fumes.

16.7.7 Specific Area Ventilation Requirements

Because of the long development drives required for the track development, several areas will require special design and infrastructure requirements when planning their construction.

Shaft 1 and Lower Virginius

Shaft 1 will need a dedicated ventilation system both during the rehabilitation and during normal operations. A 30-inch diameter rigid duct (steel or fiberglass) is suggested to draw air from the Revenue Tunnel Level down to the base of Shaft 1. The air will then exhaust back up Shaft 1 and depending upon the time frame will either exhaust on the Revenue Tunnel Level, 2,350 Level, or 2,400 Level. Only one level will be developed and ventilated at a time. The rigid duct will be required so that the level ventilation system will not collapse the Shaft 1 duct, and to increase the wear resistance of the duct installed in an operating shaft. Once development is complete the duct will be recovered from the track development. The airflow requirement for the Shaft 1 duct will be established by perceptible movement of air at the shaft base (60 ft/min) added to the airflow requirement for one track development heading. Shaft 1 duct configuration is shown in Figure 16-22.

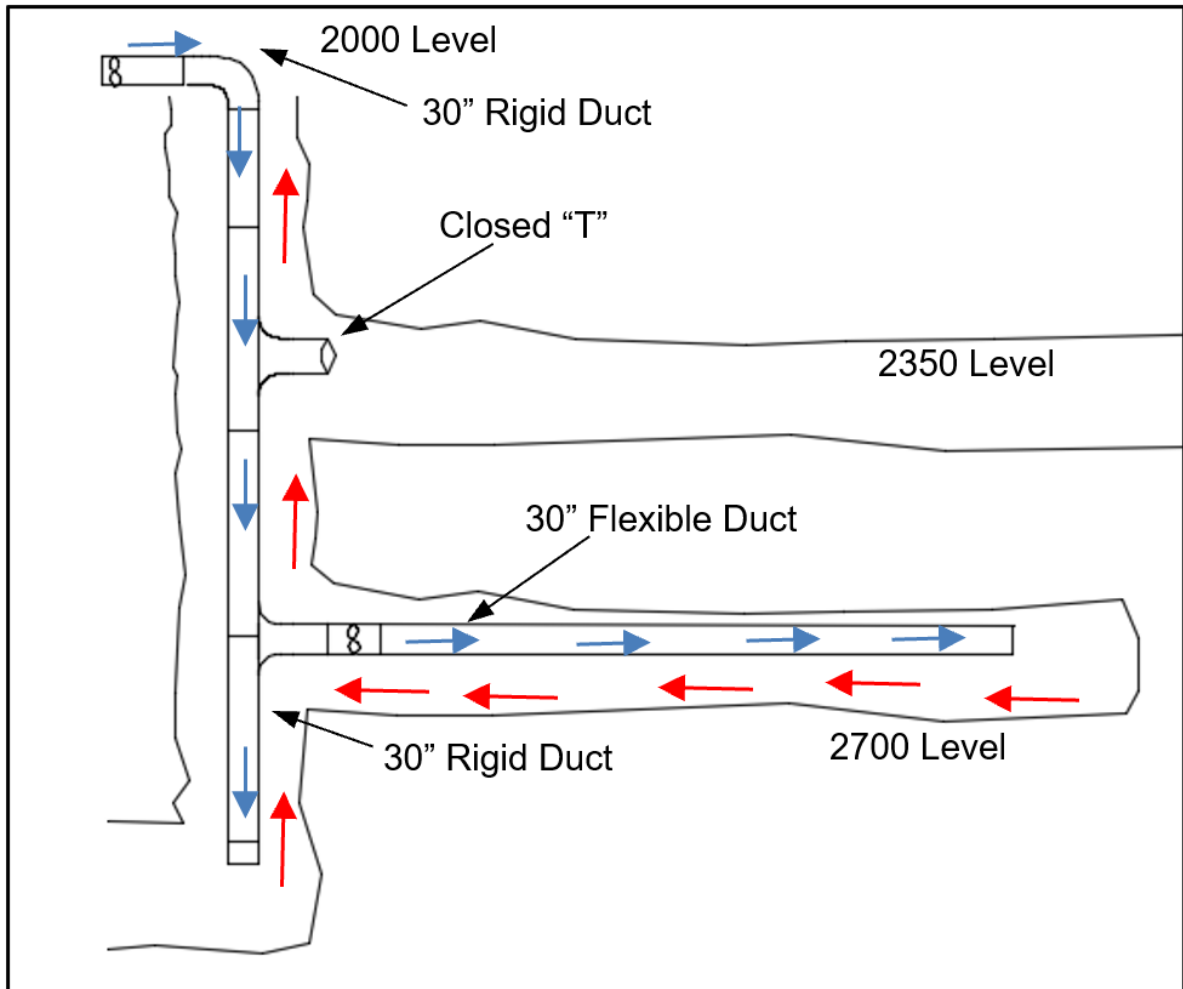

Source: SRK, 2022

Figure 16-22: Shaft 1 Duct Configuration (Example)

The Virginius South stopes will be ventilated from the top down and exhausted through Shaft 1. The Virginius North stopes will have fresh air provided by the Shaft 1 duct and the exhaust will be through the Alimak that is developed below the Upper Virginius Alimaks.

Upper Virginius

All auxiliary ventilation system ducting was assumed to be 2.5 ft (30 in) dia. flexible duct for the modeling simulations. Estimates for duct roughness and shock losses were conservative and are reflected in the auxiliary fan pressure. A 2 ft (24 in) dia. duct could be used for the level auxiliary system ventilating the stope; however, this will result in an increased operating pressure. If ore pass leakage is expected to be high, the long auxiliary systems used to ventilate the upper development level should remain 2.5 ft (30 in) dia. so that higher than normal auxiliary fan pressure requirements are avoided.

The initial development of the levels will be blind with the auxiliary ventilation system stationed on the Revenue Level. This auxiliary ventilation system for the initial level development will be stationed on the Revenue Level for the first two levels. Once a level is developed through to the exhaust raise the auxiliary duct on the level will be re-configured to provide ventilation to the inlet/fresh air side of the stope. Airflow will be pulled across the level with booster fans and bulkheads will be installed at the

end of the level near the exhaust raise. Several curtains will be required to be installed to ensure against recirculation and to induce the airflow to move naturally across the stope once airflow is delivered to the fresh air side of the stope.

Each level will have a small exhaust fan equipped with a backflow damper installed in the bulkhead accessing the escape raise as shown in Figure 16-23. As additional levels are brought on-line the main exhaust fan at the base of the raise will be turned down to maintain a constant airflow through the mine.

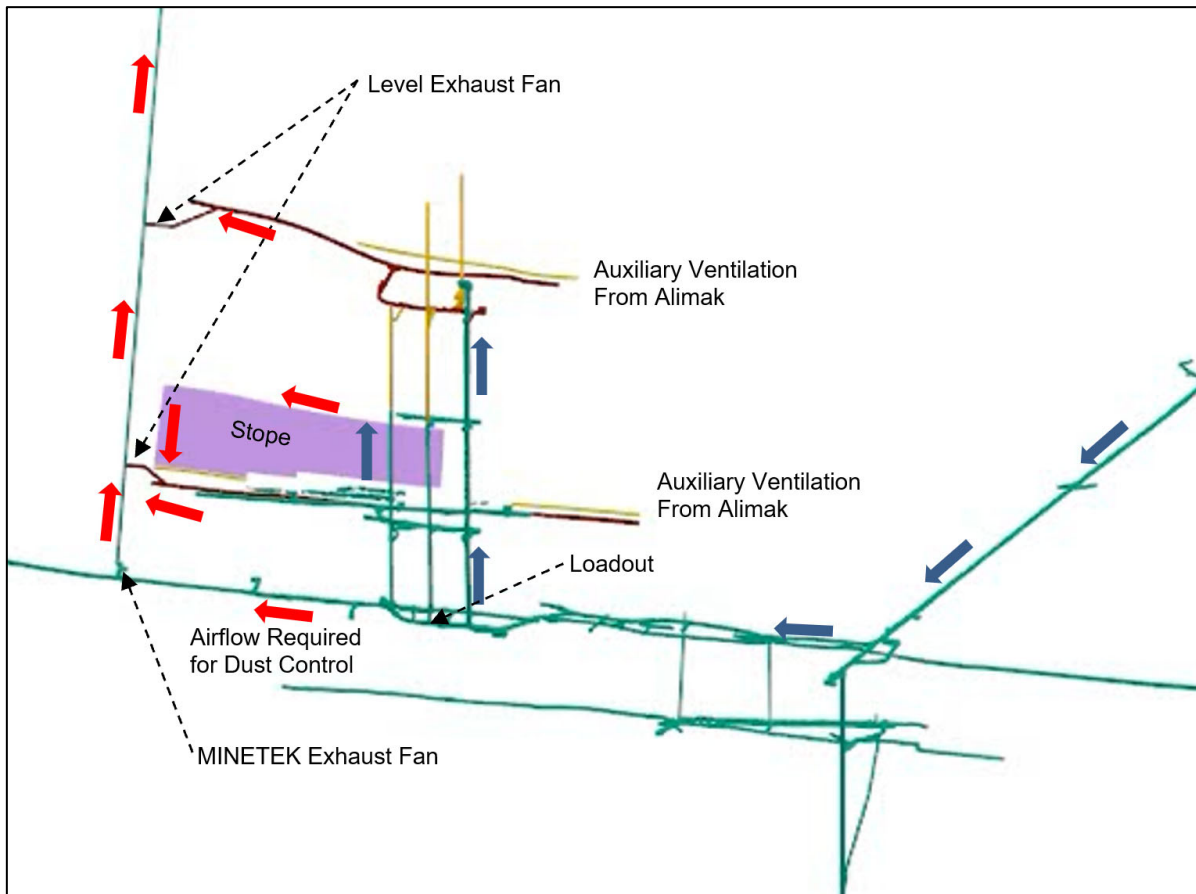

Source: SRK, 2022

Figure 16-23: General Upper Virginius Ventilation Layout

Yellow Rose

The Yellow Rose development area will require an auxiliary ventilation system to be installed to support the rehabilitation activities, Alimak development, level development, and initial stope production until the surface fan can be installed on the surface at the top of the Alimak. This will establish a flow through ventilation system that will isolate blasting fumes and limit the downstream risk should a fire occur in the area. Once the Yellow Rose surface exhaust fan is in operation, the Minetek exhaust fan at the base of the Revenue exhaust raise will be adjusted to balance the airflow through the mine to avoid excessive air velocities in the Revenue Adit portal area. The auxiliary ventilation system installed during the 2015 site visit was not adequate and will need to be upgraded. The auxiliary ventilation

system could be reduced if the Alimak is developed early, and the surface exhaust fan operated prior to any other activities occurring in this area.

Terrible

The Terrible mining zone will be developed and operated while production in the Yellow Rose is declining, and the production in the Virginius South is being finalized. The Terrible area currently incorporates an Alimak developed through the vein that extends to surface. In order to incorporate this Alimak into the ventilation system a small exhaust fan will need to be installed at the top of the Alimak. By exhausting the Alimak the raise will not have to be heated, airlocks will not be required on the level, and the Terrible mining zone can be operated independently of the Yellow Rose. It will be ventilated downstream of the Virginius South which will not allow for independent blasting. The fan required for the Alimak can be sourced from the Virginius North 600 Level once the level is finished.

Coarse Ore Bin and Crusher Gallery Connection to Revenue Tunnel

In order to ventilate the mill area without injecting dust into the main fresh air source for the mine (Revenue Adit) several auxiliary ventilation duct systems will be required to be installed along with an air door providing a separation between the ore dump points and the Revenue Adit. The air door will provide a positive separation between the two systems but will deliver a low-pressure differential.

Airflow circulation will be developed through the mill by an exhausting auxiliary duct system installed over a door. This exhausting ventilation system will draw airflow through each of the three accesses into the crusher gallery. All dust and contaminants will be exhausted through the duct system. For the purposes of modeling, low resistance brattices were assumed to be installed in this area so that fresh air would be controlled and supplied through leakage. If the leakage through the brattices is less than planned, then the remaining airflow will be drawn from the Revenue Adit which would provide an adequate flow through circuit. This configuration, as shown in Figure 16-24, was maintained for each of the design stages.

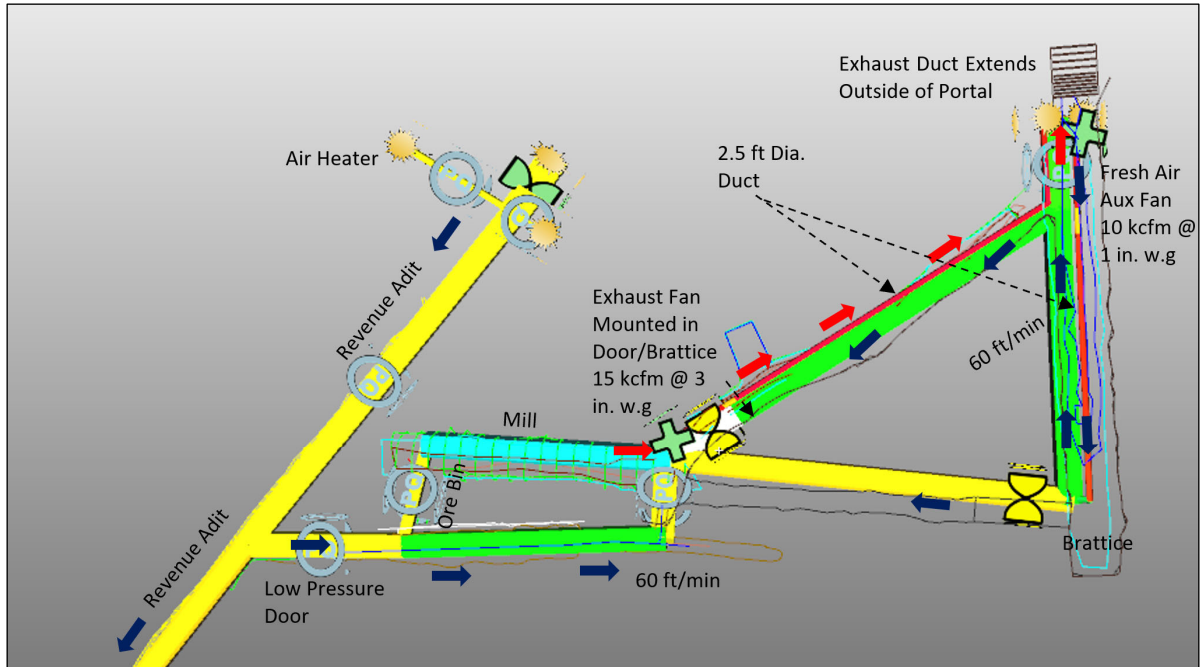

Source: SRK, 2022

Figure 16-24: Mill Ventilation

16.7.8 Air Heating

The seasonal air temperatures in the mining area are projected to be low enough to require the use of an air heater on the Revenue portal. This air heater has been installed and previously was used to provide ventilation through the mine as shown in Figure 16-25. Because the air heater was in effect providing “forcing” or positive ventilation airflow would short circuit through the mill area and higher differential pressures across the mill access door off the Revenue adit were encountered.



Eclipse Air Heater

Hurley Heater Fan

Source: SRK, 2022

Figure 16-25. Installed Air Heater

With a minimum atmospheric temperature of -17°C (1.5°F) that is heated to +3°C (37°F) a total of 0.46 MW (1.57 Mbtu) is required. During times when the air temperature is lower than the -17°C (1.5°F) which would increase the air heater requirement, the airflow through the mine can be adjusted/decreased which would decrease the heater requirement. Some additional air heating will be required to support the mill area, but this would be localized and should be minor when compared with the main portal air heater.

The monthly propane requirement calculated based upon the average monthly low air temperature is shown in Table 16-13.

Table 16-13: Monthly Gas Usage (LPG)

	Requirement/Month, based on Daily Average Minimum											
	January	February	March	April	May	June	July	August	September	October	November	December
Airflow (m ³ /s)	26.0	26.0	26.0	26.0	26.0	26.0	26.0	26.0	26.0	26.0	26.0	26.0
Air Density (kg/m ³)	0.80	0.80	0.80	0.80	0.80	0.80	0.80	0.80	0.80	0.80	0.80	0.80
Air Density (kg/m ³)	0.88	0.88	0.88	0.88	0.88	0.88	0.88	0.88	0.88	0.88	0.88	0.88
Temperature Rise (°C)	19	18	14	11	6					6	13	18
Mass Flow of Air (kg/s)	22.8	22.8	22.8	22.8	22.8	22.8	22.8	22.8	22.8	22.8	22.8	22.8
Heat Requirement (MW)	0.44	0.40	0.32	0.26	0.14	0.00	0.00	0.00	0.00	0.14	0.30	0.41
Heating Value (MJ/l)	0.1	0.1	0.1	0.1	0.1	0.1	0.1	0.1	0.1	0.1	0.1	0.1
Propane Gas Flow Rate (l/s)	4.3668	4.0224	3.2317	2.6196	1.4462	0.0000	0.0000	0.0000	0.0000	1.4462	2.9639	4.1117
Propane Gas Flow Rate (l/hr)	15720.4	14480.8	11634.2	9430.4	5206.5	0.0	0.0	0.0	0.0	5206.5	10670.1	14802.2
Monthly Requirement gas (l/month)	11696008	9731100	8655866	6789908	3873619	0	0	0	0	3873619	7682447	11012830
Monthly Requirement LPG (l/month)	43319	36041	32059	25148	14347	0	0	0	0	14347	28454	40788
Monthly Requirement LPG (gal/month)	11444	9521	8469	6643	3790	0	0	0	0	3790	7517	10775

Source: SRK, 2022

16.7.9 Equipment and Infrastructure Summary

Based on the development of the ventilation models a summary of the required fans/ducts has been developed as reflected in Table 16-14. The fan pressures do not include allowances for silencers, these will be included in the fan specification and model selection.

Table 16-14: Fan/Ducts Registered

System	Delivered Airflow (kcfm)	Duct	Fan Requirement		Fan Model (Spendrup)
			Airflow (kcfm)	Pressure (in. w.g.) ¹	
Mill Exhaust	14.2	24 inch	15.0	3.18	100-060-1800, 39 inch diameter 30hp, \$25,796
Mill Fresh Air	9.7	24 inch	10.0	1.00	071-040-1200, 28-inch diameter 5hp, \$18,805
Initial Level Development	6.0	30 inch 2000 ft	13.0	9.25	063-045-3600, 25-inch diameter, 50hp, \$20,474
Production Level (extended to materials raise)	6.0	24 inch 1100 ft	8.0	8.36	063-045-3600, 25-inch diameter, 50hp, \$20,474
Production Level (extended to the materials raise)	6.0	24 inch 1100 ft	8.0	8.36	063-045-3600, 25-inch diameter, 50hp, \$20,474
Development Level (extended one level below)	6.0	30 inch 1643 ft	12.0	7.48	063-045-3600, 25-inch diameter, 50hp, \$20,474

System	Delivered Airflow (kcfm)	Duct	Fan Requirement		Fan Model (Spendrup)
			Airflow (kcfm)	Pressure (in. w.g.) ¹	
600 Exhaust Fan / Terrible	10.0		10.0	1.2 + damper	071-040-1200, 28-inch diameter 5hp, \$18,805
900 Level Exhaust Fan	10.0		10.0	1.2 + damper	071-040-1200, 28-inch diameter 5hp, \$18,805
1800 Level Exhaust Fan	10.0		10.0	1.2 + damper	071-040-1200, 28-inch diameter 5hp, \$18,805
Shaft 1 Fresh Air	20.0	30 inch Rigid 970 ft	24.0	12.6	100-060-C-2-D 100hp \$37,080
2350 Level (South)	6.0	30-inch Bag 3500 ft	14.5	16.0	063-040-3600-A-3-D 2 Stage 80hp \$32,897
2400 Level (North)	6.0	30-inch Bag 2250 ft	10.0	7.0	063-040-3600-A-1-D 40hp \$19,807
2700 Level (South)	6.0	30-inch Bag 2250 ft	10.0	7.0	063-040-3600-A-1-D 40hp \$19,807
Main Exhaust Fan (Base of Escape Raise)	55.0	n/a	55.0	2.4 (1.0 for losses)	MINETEK 2-122435W (Installed)
Surface Exhaust Fan (Yellow Rose)	50.0		50.0	1.4 (collar) +1.0 Inst Loss	112-060-1800 60hp, \$28,617
Yellow Rose Access Rehab Duct System	25.0	42 inch 2345ft	32.0	18.2	100-060-1800-C-2D 200hp Total (2 fans)

Source: SRK, 2022

Doors

Equipment doors will be required around the mill area. These doors are already either installed or have been installed previously and may need to be rehabilitated. Because the main fans will be installed at the main exhaust raise the mill will be in parallel with the Revenue Adit portal, the differential pressure across the mill doors will be minimal. The airflow through the mill and crusher area will be controlled by the exhaust fan/duct mounted in the mill door as shown in Figure 16-24. These doors will only provide basic isolation, leakage will be required.

There are additional vein accesses that are open which are not currently ventilated; Yellow Rose, Anglo Saxon, Atlas, Cumberland, Terrible, and Virginus South. These areas should be chained off to disallow personnel from entering the potential dead space. Doors may be required to hinder egress, however from a ventilation perspective they should not be required.

Bulkheads

Bulkheads or bulkheads with inspection doors will be required at the base of the ore/waste passes in the Alimak access, and on the level accesses for the ore/waste passes. The differential pressure resulting from the ventilation system will be minimal, however, the pressure induced by falling rock will generate pressure pulses.

Curtains

Curtains will be required to be used in a number of locations. Their flexibility will allow for them to be moved/relocated as conditions change on the mining levels. Curtains will be required to be installed around the fresh air duct leading into the stope access raise. Of the 6 to 7 kcfm supplied to the stope

raise, approximately 2.5 to 3 kcfm will be drawn up the stope access raise and across the stope. The leakage through the curtain will be used to ventilate the footwall drive leading to the stope access. The curtain will not seal the stope access, rather it will be used to direct flow.

Additional curtains may be required around the men/materials raise depending upon how well the leakage/recirculation around the ore/waste pass is controlled.

Ore Pass Isolation Curtains

One of the key aspects to this ventilation system will be the control of leakage/recirculation around the ore/waste passes. In order to control the leakage/recirculation it is suggested that, at the very least, conveyor belt type material be laid across the grizzly bars on the upper-level dump points. This will help to manage the dust plumes on lower levels caused by dumping on upper levels and minimize leakage/recirculation. The differential pressure across items will be minimal.

16.8 Mine Services

16.8.1 Hoisting

The existing #1 shaft will be refurbished and a production hoist for men, materials, and production will be installed. OSMI retained Harrison Western Construction Corporation (HWC) to provide engineering on the hoist system. HWC completed the engineering in 2016 and multiple bids were received for the rehabilitation work. OSMI has taken over the work on #1 shaft. The hoist is designed to have a capacity of move 30 to 35 st/h when hoisting from the 2700 level. This is lowest level currently in the mine plan. The contract rate is estimated at eight productive hours per 10-hour shift.

SRK assumes conservative average of five productive skipping hours per shift, which allows for ten skipping hours per day and equates to 300 to 350 st/d. This is 20% to 30% over the current plant planned production of 270 st/d. Additionally, the system will have a greater capacity at levels above the 2700.

The hoisting system will include the 500 hp 96-inch diameter hoist, underground headframe and sheave, skip dumping pocket at the 2000 level, shaft guides, 7/8-inch diameter wire rope, 1.5 st skips and man-cage. Loading pockets will be established or rehabbed on all production levels 2210, 2350, and 2700 levels.

The hoist will be staffed by a hoist man and a skip tender that will assist on the level that is being loaded.

The Shaft #1 project will start in ramp up (August of 2022 and continue for 11 months completing in July of 2023 with a total estimated cost of US\$4 million.

16.8.2 Compressed Air

The mine production equipment is primarily air powered. The current air equipment includes slushers, jack leg and stoper drills, overshot muckers, air tuggers, air slushers, air operated chutes, air operated pumps, and miscellaneous air operated tools. The existing compressed air system was upgraded and is in place and operational.

16.8.3 Dewatering

Mine dewatering is only required below the shaft collar. The Revenue Tunnel is driven at a gentle uphill grade to the shaft and each direction (north and south) on vein allowing gravity drainage. All levels above the tunnel level will self-drain through raises to the tunnel level. For level accessed via shaft below tunnel level will be dewatered via electric pumps located in the shaft sump. The shaft pumps will pump into the partially completed Terrible decline where a central water system will be constructed that will feed water to various locations around the mine for use by mining crews. Automated valves will control water from the central system when coffer dams for mine stoping use reach low levels. Excess water from the Terrible sump will overflow back into the main Revenue Tunnel and out to the portal where it is treated in the bio-reactive passive treatment system as described in the Section 18.2.6.

16.8.4 Electrical

The underground electrical supply initiates in the Project substation transformer and is provided by a power line (4,160 V) suspended from the back in the main haulage to the mine workings in the Yellow Rose and Virginius areas. Further discussion is located in Section 18.2.8.

16.8.5 Health and Safety

The mine has an emergency escape plan (SMO escape plan 3-11-14) which has been accepted by MSHA. There is a refuge station and first-aid/lunchroom in both the Yellow Rose and Virginius sections of the mine. A stench warning system is installed on the compressed air line entering the mine as well as the air intake for the mine ventilation. Underground communications consist of mine telephones at key locations; future plans are for the mine supervisors to also have hand-held radios.

In the Virginius section of the mine, an 8 ft diameter raise ventilation borehole (Hubb-Reed raise) has been installed from the Virginius haulage level to surface has been rehabilitated and has an operating hoist system with a bullet type skip. The 1,465 ft long raise borehole acts as an exhaust vent and has a working man-lift conveyance for emergency egress. In the Yellow Rose, a secondary escape-way will be developed to the surface.

A tag in/tag out board is used at both portals. All underground personnel are issued with portable self-rescuer units. A total of 12 Ventis MX4 portable gas detectors are at the mine and made available for use in underground and confined space entry. The mine's current policy is that at least one person in each working area of the underground mine will carry a MX4 detector. The alarms have been set on these detectors to go off at 35 ppm CO, 19.5% oxygen, 3 ppm NO₂, and 10% LEL. The safety department also has two Ibrid MX6 gas detectors – one set up for Oxygen, CO, H₂S, and LEL and the other set up for oxygen, CO, SO₂, H₂S, and LEL. The latter is equipped with a pump. All pumps are on a regular calibration schedule.

OSMI currently has one qualified Mine Rescue Team and has an agreement in place with the San Juan Mine Rescue in order to meet MSHA small mine criteria.

16.8.6 Mining Labor

The mining labor will consist of a supervisory team including a Mine Manager, Mine Superintendent, and Shifters. The mine team will be supported by a Mine Engineer, Geologist, Jr. Geologist, Sample Geologist, Surveyor and Surveyor Assistant. The labor force will consist of three levels of miners, that will cover mining, tramming, swamper, hoist men, skip tenders, and a bull gang (general maintenance

underground miners). Maintenance duties will be provided by mechanics and electricians that provide overall maintenance support to the mine, processing plant, and surface facilities associated with the Project. Maintenance is carried separate from the mining labor and not include here. The management team will be on straight day shift with the shifters and mining labor on a rotating 10-hour shift two shifts per day. Table 16-15 shows the mining and technical team supporting mining. The mine will have approximately 20 personnel rotating on shift with the support of the bull gang personnel who work a straight night shift schedule. The total mining staff is approximately 96 people.

Table 16-15: Mining Personnel Position and Number

Position	# of Staff
Technical	
Sr. Mining Engineer II	1
Mining Engineer	1
Sr. Geologist	1
Geologist	1
Junior Geo	2
Surveyor	1
Surveyor Assistant	1
Environmental Specialist	1
Mining	
Mine Manager	1
Mine Superintendent	1
Shifter	4
Miner Tech VII	1
Miner I	16
Miner II	20
Miner III	20
Bull Gang	6

Source: OSMI 2021

16.8.7 Grade Control

As part of the routine mining sequence OSMI will be required to complete a grade control program to monitor the mining production. The aim of the grade control program is to deliver the most economic tons to the mill via accurate definition of “ore” and waste. The basis of a successful program in an underground environment will be via detailed geological mapping and quality sampling ahead of the mining. For underground operations sampling methods include chip, channel and panel samples, grab/muck pile samples, and drill-based samples.

Grade control will be conducted on a daily basis with the geology team by the junior geologist and sample geologist, taking lead responsibility to delineate the vein, obtain samples for testing, and to update and correlate the database with production data to improve prediction of production grades.

The current proposed mining methods will result in scam developments that are approximately 300 vertical ft apart along the vein structure. This will enable channel sampling to be completed at regular intervals. The current sample spacing within the mine is in the order of 6 to 10 ft, which SRK considers to be reasonable spacing for this style of deposit. Samples should be taken across the full width of the vein with sufficient volume taken to ensure accurate assay. The aim of the sampling should be to achieve a sample weight the equivalent of at minimum half NQ core for the sampling interval. The channel samples should be logged geologically marking the width of the vein and any hanging wall or footwall mineralization. SRK envision that the samples should be processed at an onsite facility to enable quick turnaround.

Understanding variations led by clear and accurate mapping will be important, as veins can show features relating to erratic grade distribution (nugget effect), and variable geometry. These features include variations in dip, strike and width, late-stage faulting/shearing effects and vein continuity and type. SRK assumes the mine geologist will perform daily mapping of each back, as well as define the ore/waste contact for the mining teams. The daily mapping should be incorporated into a digital format to further improve the geological model and enable the development of short-term estimation.

The geological team will provide calls of resue ore/waste shots pre-shot, post ore-shot inspection and muck sampling and reconciliation between stope muck, mill feed head grades and processing mass balance. Photos and digitized measurements will be used whenever available.

Once the 3 ft wide by 8 ft high scam drift has been established the mining sequence will involve drilling and blasting initially of the defined vein material, followed by the waste in a separate blast. As the mine face develops it is estimated that the stope working environment will have closer to 1.5 ft by 6 ft wide, which will make sampling difficult, resulting in grab sampling as the most likely form of sampling to test stope grades. Grab sampling can result in selection bias if not conducted following a routine defined protocol.

SRK recommends that OSMI create a series of protocols to cover all grade control tasks from mapping to sampling and integration with the database. On-going quality assurance/quality control monitoring and review will allow protocols and staff to be updated as required.

17 Recovery Methods

The concentrator has been redesigned into four specific processing areas to recover lead, copper, zinc, silver and gold. The first processing area consists of several stages of crushing and grinding for particle size reduction designed to achieve sufficient mineral liberation. The next two areas include multiple stages of selective flotation to recover lead, copper, zinc, silver and gold into separate lead and zinc flotation concentrates. The final stage of this process includes thickening and filtering of both the flotation concentrates and the final tailings and product storage prior to shipping. The tailings will be filtered, transported, and stored in a DSTF.

17.1 Introduction

The existing processing facility was designed by CH2MHill and operated from 2013 to 2015. The processing facility experienced a number of issues and required reconfiguration and upgrades in order to recover the desired products at the rates and mill feed head grades envisioned in this report. The primary issues experienced from the original design included:

- Ore variability
- Blasting method required excess processing of waste material
- Physical characteristics (stickiness) of the ore which led to plugging issues in the various material handling systems

Lycopodium Minerals Canada, Ltd. (Lycopodium) and SRK were hired to study process upgrades in 2016. Lycopodium produced a separate process design report, which was then incorporated into a PFS report authored by SRK (SRK, 2016; Lycopodium, 2016). Both reports were completed in mid-2016. These PFS reports describe the basic process upgrades envisioned, the testwork that was used as a basis of design, and the capital and operating cost associated with the process upgrades.

In early 2017, Barr was hired to further the process design originated by Lycopodium and to complete design of the process and capital improvements in the processing area to a level sufficient for OSMI to solicit bids for construction.

Barr reviewed the Lycopodium report and other referenced reports. OSMI also provided further direction to Barr regarding their desired processing methods, equipment, and products. Barr then completed a mineral process model using simulation software. The process design completed by Barr is described in the balance of this section. Capital costs for the processing plant upgrades in Section 21.1 are based upon contractor bids received in May 2017 for the engineering design completed by Barr. Operating costs for the upgraded processing plant in Section 21.2 are based upon the process described in this section, vendor information for consumables, and first principles.

The main differences between the 2016 Lycopodium report (Lycopodium, 2016) and the completed process model developed by Barr include:

- 12-inch grizzly added ahead of the RoM ore dump pocket
- Screw conveyor feed to the ball mill was added
- Lead/copper flotation concentrate separation circuit was eliminated
- Increased flotation capacity and retention time to improve recovery and concentrate grades
- On-line stream analyzing was eliminated
- Process flow sheets adjustments based on new laboratory testing by FLSmidth (FLSmidth, 2017, FLSmidth2, 2017)

- Improvements to the primary and secondary grinding circuits for material transfer and storage
- Improvements to the storage capacity of final concentrate prior to material filtering
- Bridge crane added in the crushing and rod mill area to improve maintenance and operation needs

17.2 Processing Methods

The process plant consists of the following principal process areas (each described in more detail in the subsequent sub-sections). While the detailed design of the process upgrade completed by Barr in 2017 was for an instantaneous feed to the rod mill of 13 metric tonnes per hour (mt/h) (14.4 st/h), values in this report have been adjusted for an annualized design throughput of 91,390 st/y.

- ROM Storage and Crushing (section 17.3.1)
- Primary Rod Milling (section 17.3.2)
- Secondary Ball Milling (section 17.3.3)
- Bulk Lead Rougher Flotation (section 17.3.4)
- Zinc Rougher Flotation (section 17.3.5)
- Lead Cleaner Flotation (section 17.3.6)
- Zinc Cleaner Flotation (section 17.3.7)
- Lead Concentration Thickening and Filtration (section 17.3.8)
- Zinc Concentration Thickening and Filtration (section 17.3.9)
- Tailings Thickening and Filtration (section 17.3.10)
- Reagent Mixing, Storage and Distribution (section 17.3.11)
- Raw Water Storage and Distribution (section 17.3.12)
- Process Water Storage and Distribution (section 17.3.13)
- HP and LP Air Services (section 17.3.14)

The primary products from the process plant include:

- A lead concentrate, into which 95% of the lead, 95% of the silver, 68% of the gold and 91% of the copper will be recovered
- A zinc concentrate with minor amounts of silver and gold
- A dewatered and filtered tailings for disposal

A simplified flowsheet with the principal process areas is shown in Figure 17-1.

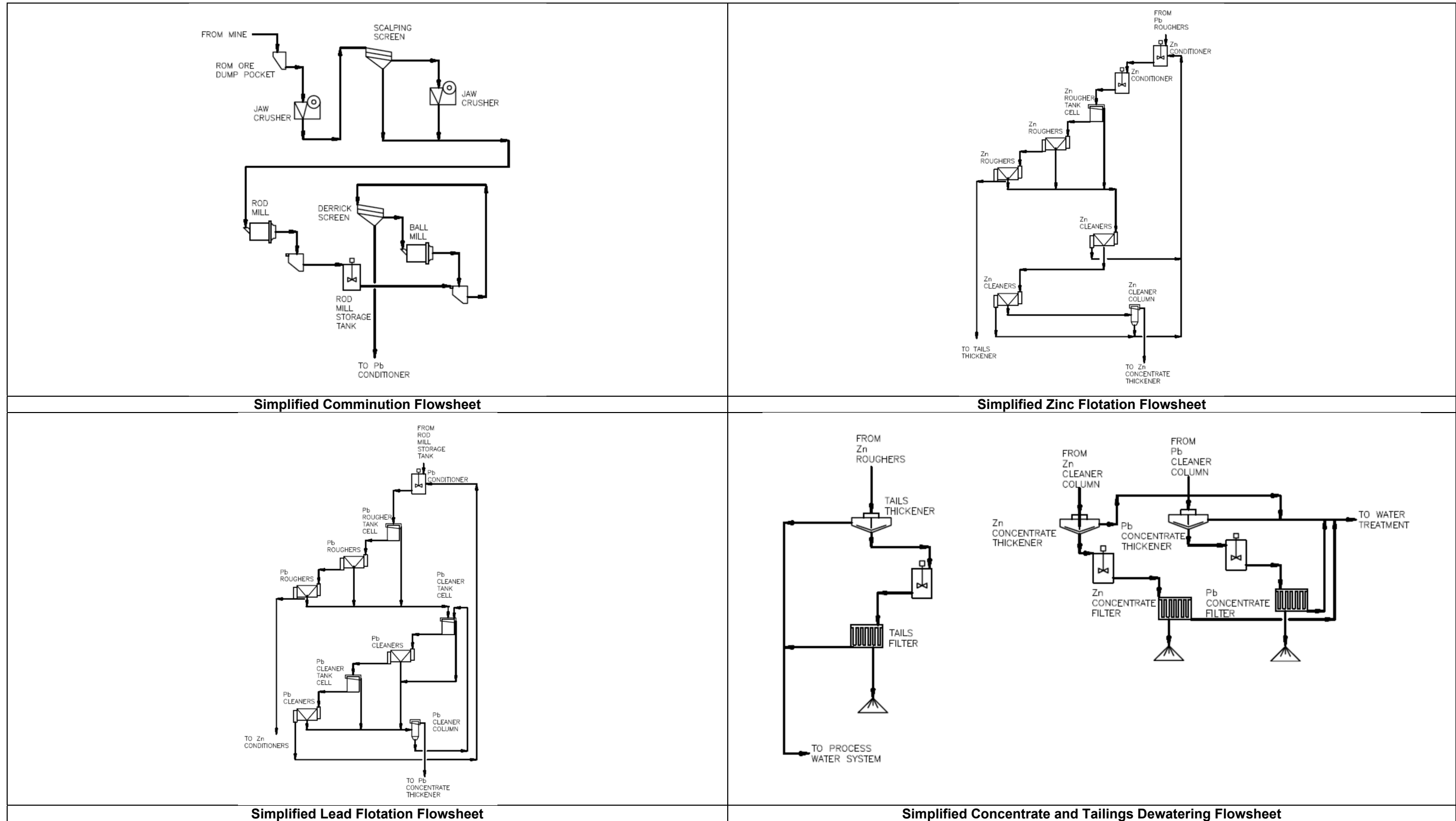

Source: SRK, 2017

Figure 17-1: Simplified Process Flowsheet with the Principal Process Areas

17.3 Process Design and Flowsheet Description

The following process design assumptions were taken from the Lycopodium report (Lycopodium, 2016), and updated where Barr's process design impacted the descriptions:

- The feed rate and ore grades were provided by OSMI.
- Key ore characteristics provided in the design criteria have been determined by testwork, or where absent, taken from similar ore types and previous experience. The design criteria were built upon the design basis previously completed by Lycopodium and updated where needed based on additional information.
- The crushing circuit consists of a Metso C80 primary jaw crusher feeding a scalping screen in front of a secondary McLanahan 1248 jaw crusher designed to produce a rod mill feed size of 80% passing (F80) 0.9 inch.
- The grinding circuit consists of a rod mill operated in open circuit feeding a ball mill operated in closed circuit with Derrick Flo-line screens designed to produce a final grind size of 80% passing (P80) 130 μm . A surge tank between the rod and ball mill circuits was originally included in the flowsheet to buffer out the availability difference between crushers/rod mill and the downstream ball mill circuit and flotation. It is noted, however, the surge tank was not installed due to issues related to suspension and pumping of very coarse material.
- The primary lead flotation circuit consists of a pre-conditioning tank prior to the lead rougher flotation circuit. This is followed by two stages of lead cleaner flotation including a final column flotation cell. The final lead concentrate is thickened prior to filtration.
- The zinc flotation circuit consists of two pre-conditioning tanks prior to zinc rougher flotation. The zinc rougher circuit is followed by three stages of zinc cleaner flotation including a final column flotation cell. The final zinc concentrate is thickened prior to filtration.
- Both concentrates are dewatered in their own dedicated thickener; the thickener overflows are recycled to the filtrate tank. The thickener underflow is sent to a filter feed tank and dewatered in a vertical plate filter press. All concentrates are bagged using a screw conveyor and bagging system.
- The final tailings from the zinc flotation circuit are thickened and the thickener underflow is sent to a filter feed tank and dewatered in a vertical plate filter press to produce dewatered tailings to be dry stacked at the tailing storage facility (TSF). The thickener overflow is recycled to the process water tank.

The key process design criteria listed in Table 17-1 were the basis for detailed process design and development of the mechanical equipment list (SRK, 2016).

Table 17-1: Key Process Design Criteria Parameters

Criteria	Units	Primary	Source
Mill Days per Year	days	365	OSMI
Mill Utilization	%	98	OSMI
Mill operating days per year	days	358	OSMI
Mill planned downtime	days	12	OSMI
Mill planned operating time	days/yr	346	OSMI
Planned availability	%	97	OSMI
Unplanned downtime:	%	2	OSMI
Unplanned down days:	days	8	OSMI
Total operating days per year	days	337.4	OSMI
Total operating time per year	%	92	OSMI
Plant Capacity per operating day ⁽¹⁾	st/d	270	OSMI
Annual Throughput ⁽¹⁾	st/y	91,390	OSMI
Copper Head Grade	% Cu	0.15 to 0.47	OSMI
Lead Head Grade	% Pb	3.1 to 7.2	OSMI
Zinc Head Grade	% Zn	1.2 to 2.7	OSMI
Lead Recovery	%	94.7	Testwork
Zinc Recovery	%	73.2	Testwork
Crushing/Rod Mill Availability	%	80	OSMI
Process Plant Availability	%	92	OSMI
Crushing Work Index	kWh/st	14.4	Testwork
RWi	kWh/st	15.1	Testwork
BWi	kWh/st	16.2	Testwork
Abrasion Index	g/rev	0.2669	Testwork
Drop Weight Axb		37.5	Calculated
SG		2.70	OSMI
Grind Size (P80)	µm	130	Testwork
Lead Conc. Grade ⁽²⁾	% Pb	65	SRK –Sec13.4
Zinc Conc. Grade ⁽²⁾	% Zn	54	SRK Sec13.4
Lead Metal Production	st/y	6,850	Calculated
Zinc Metal Production	st/y	1,367	Calculated

- (1) Plant capacity per operating day and annual throughput match the mine plan. Instantaneous processing rates for the processing plant equipment exceed the mine plan capacity. The crusher and rod mill are sized for 14.4 st/h, and the remainder of the process is sized for 12.5 st/h.
- (2) Process testing (FLSmith 2017) indicates that the concentrate grades listed are achievable, but the engineering design work completed by Barr and used for equipment design considered both normal and maximum flows (+27%)

17.3.1 Run-of-Mine Storage and Crushing

Run-of-mine (RoM) ore is delivered to the ore dump pocket by rail haulage from the underground mine and dumped onto a grizzly with 8-inch openings. A small rail mounted track hoe with a hydraulic pick is used to break oversize rock which remains on the grizzly. RoM ore is drawn from the dump pocket, at a controlled rate, by a variable speed apron feeder and discharged onto the RoM ore conveyor. A static magnet, located at the head of the conveyor, removes tramp metal from the jaw crusher feed. The single-toggle primary jaw crusher is operated in open circuit.

The primary crusher product discharges onto the secondary crusher feed conveyor, which conveys the ore onto a scalping screen prior to feeding secondary jaw crusher which is operated in open circuit. The secondary jaw crusher product discharges onto the rod mill feed conveyor, which is equipped with a weightometer for mass flow rate measurement and control. The weightometer will indicate the instantaneous and totalized rod mill feed rate.

A local spillage pump will return all crushing area spillage to the rod mill discharge storage tank.

17.3.2 Primary Rod Milling

The primary grinding circuit consists of a rod mill operated in open circuit. The rod mill feed rate is controlled by the variable-speed RoM ore apron feeder. Process water is added to the rod mill feed chute in order to achieve the required slurry density. Ground slurry discharges from the rod mill through the rod mill trommel screen and flows to the rod mill discharge pump box. The slurry is diluted further with process water prior to being pumped to the secondary ball mill grinding circuit. A dedicated rod charger is provided to assist with the required rod charging activities. Broken rod chips are discharged from the rod mill from the trommel screen.

17.3.3 Secondary Ball Milling

The secondary grinding circuit consists of a ball mill operating in closed circuit with a Derrick screen. Slurry from the rod mill discharge storage tank is transferred at a controlled mass flow rate to the Derrick screen feed pump box.

Process water is added to the ball mill feed chute in order to achieve the required slurry density. The flotation depressants, sodium metabisulfite and zinc sulfate, were designed to be added to the ball mill feed chute but are now being added to the rod mill in order to increase the available conditioning time. Ground slurry discharges from the ball mill through the ball mill discharge trommel screen and flows to the Derrick screen feed pump box. The slurry is further diluted with process water prior to being pumped to the Derrick screen feed distributor.

The Derrick screen separates the slurry into fine and coarse fractions. The coarse screen oversize stream is recycled back to the ball mill for additional grinding. The fine screen undersize, at a design grind size of P80 130 μm , is advanced to the lead flotation conditioning tank at a slurry density of about 30% solids (w/w).

An overhead crane is used to transport new grinding media to the wet screen floor above the ball mill. The grinding media is manually charged into the ball mill through a dedicated ball charge chute. A dedicated sump pump returns all secondary milling area spillage to the Derrick screen feed pump box.

17.3.4 Bulk Lead Rougher Flotation

The bulk lead rougher flotation circuit consists of a new 106 ft³ (3 m³) agitated rougher conditioning tank followed by a new, single 177 ft³ (5 m³) tank-type flotation cell and six existing 60 ft³ (1.7 m³) trough-type flotation cells in series.

Derrick screen undersize from the grinding circuit flows by gravity into the rougher flotation conditioning tank. Reagents such as collector and depressants are added to the rougher conditioner tank along with process water for dilution to the required slurry density. Frother is added to the feed box of the rougher flotation cells.

Low-pressure air is supplied to each flotation cell and controlled by vendor-supplied instrumentation or manually adjusted by the operator. Similarly, cell slurry levels are controlled by vendor-supplied instrumentation. Launder and sump water sprays are provided to assist in discharge of concentrate from launders and froth breakdown.

Rougher concentrate reports to the rougher concentrate sump and pumps, which deliver slurry to the lead cleaner circuit. Rougher tailings are pumped to the zinc rougher flotation circuit conditioning tank-1. Spillage from the lead rougher circuit will be directed to rougher sump and pumped to the lead rougher conditioning tank or to the zinc rougher conditioning tank.

17.3.5 Zinc Rougher Flotation

The zinc rougher flotation circuit consists of two, new, 124 ft³ (3.5 m³), agitated-rougher conditioning tanks followed by a new, single, 177 ft³ (5 m³), tank-type flotation cell and six, existing, 60 ft³ (1.7 m³), trough-type flotation cells in series.

Tailings from the bulk lead rougher flotation circuit are pumped to the first zinc rougher conditioner tank. Hydrated lime is added to the first conditioning tank adjust the operating pH. Copper sulfate and zinc mineral collector are added in the second conditioning tank. Frother is to be added to the feed box of the rougher flotation cells.

Low-pressure air is supplied to each flotation cell. The air flow to each cell is to be controlled by vendor-supplied instrumentation or manually controlled by the operator. Similarly, cell slurry levels are to be controlled by vendor-supplied instrumentation. Launder and hopper water sprays are provided to assist in discharge of concentrate from launders and froth breakdown.

Rougher concentrate is to report to the rougher concentrate sump and pumps, which deliver slurry to the zinc cleaner circuit. Zinc rougher tailings are to be pumped to the final tails thickener.

17.3.6 Lead Cleaner Flotation

Upgrading of the bulk lead rougher concentrate is designed to be conducted in a cleaner flotation circuit that includes two stages of cleaner flotation. The first stage lead cleaner flotation circuit consists of one, new, 177 ft³ (5 m³), tank-type flotation cell and two 16 ft³ (0.4 m³), trough-type flotation cells in series. Low-pressure air is supplied to each flotation cell. The air flow to each cell is controlled by vendor-supplied instrumentation or manually controlled by the operator. Similarly, cell slurry levels are controlled by vendor-supplied instrumentation. Launder and hopper water sprays are provided to assist in discharge of concentrate from launders and froth breakdown.

First-stage cleaner flotation tailings flow to a cleaner-scavenger stage which consists of one, new, 177 ft³ (5 m³), tank-type flotation cell and two 16 ft³ (0.4 m³), trough-type flotation cells in series. First-stage lead cleaner concentrate is to be further upgraded in one column flotation cell. The cleaner-scavenger concentrate is also pumped to the column cell and the cleaner-scavenger tailings are to be pumped back to the lead rougher flotation conditioners. The column cleaner concentrate is final concentrate that is pumped to the lead concentrate thickener and the column cleaner tails are to be pumped to the lead cleaner flotation tank cell-1.

17.3.7 Zinc Cleaner Flotation

Upgrading of the zinc rougher concentrate is designed to be conducted in a cleaner flotation circuit that includes three stages of cleaner flotation. The first-stage zinc cleaner flotation circuit consists of one, new, 177 ft³ (5 m³), tank-type flotation cell and two 16 ft³ (0.4 m³), trough-type flotation cells in series. Similarly, the second-stage zinc cleaner flotation circuit consists of two 16 ft³ (0.4 m³), trough-type flotation cells in series. The third-stage cleaner circuit consists of one column flotation cell. Reagents, including collector and frother, are to be added to the feed box of the flotation cell, as required. Low-pressure air is supplied to each flotation cell. The air flow to each cell is controlled by vendor-supplied instrumentation or manually controlled by the operator. Similarly, cell slurry levels are controlled by vendor-supplied instrumentation. Launder and hopper water sprays are provided to assist in discharge of concentrate from launders and froth breakdown.

Concentrate from the zinc rougher flotation circuit is to be pumped to the first-stage zinc cleaner. The first-stage zinc cleaner concentrate is pumped to the second-stage cleaner circuit and first-stage cleaner tailing is pumped to the zinc rougher flotation conditioners. The second-stage cleaner concentrate is pumped to the column flotation cell and the second-stage cleaner tailing is pumped back to the zinc rougher flotation conditioners. The column flotation cell concentrate is to be the final zinc concentrate which is advanced to the zinc concentrate thickener. The column flotation tailings are cycled back to the zinc rougher flotation conditioners.

17.3.8 Lead Concentrate Thickening and Filtration

Lead concentrate from the lead flotation circuit is pumped to the lead concentrate thickener where flocculant is added to promote thickening of the concentrate.

Thickener overflow gravitates to the common concentrate thickener overflow tank which is then pumped to the filtrate water tank. Thickener underflow is pumped to the agitated lead concentrate filter feed tank, which provides surge capacity between the thickener and filter.

Lead concentrate is pumped in discrete batches to the lead concentrate filter, which filters the concentrate to about 10% moisture. After the desired filtration cycle time, the filter press opens, and discharges lead concentrate to the lead concentrate bagging system via the concentrate discharge screw conveyor. The filter cloths are manually washed on an as needed basis. Filtrate from the lead concentrate filter gravitates to the filtrate water tank.

Lead concentrate discharging to the concentrate bagging system will be manually sampled for metal accounting purposes. Concentrate mass will be determined by the bagging system weigh scale.

A common sump pump in the concentrate thickening and filtration area is provided to return spillage to the respective concentrate thickener.

17.3.9 Zinc Concentration Thickening and Filtration

Zinc concentrate from the zinc cleaner column is to be pumped to the zinc concentrate thickener where flocculant is added to promote thickening of the concentrate.

Thickener overflow gravitates to the common concentrate thickener overflow tank, which is then pumped to the filtrate water tank. Thickener underflow is to be pumped to the agitated zinc concentrate filter feed tank, which provides surge capacity between the thickener and filter.

Zinc concentrate is to be pumped in discrete batches to the zinc concentrate filter, which filters the concentrate to about 10% moisture. After the desired filtration cycle time, the filter press opens, and discharges zinc concentrate to the zinc concentrate bagging system via the concentrate discharge screw conveyor. The filter cloths are manually washed on an as needed basis. Filtrate from the zinc concentrate filter gravitates to the filtrate water tank.

Zinc concentrate will be pumped in discrete batches to the zinc concentrate filter using the zinc filter feed pumps. The filter will remove water from the concentrate to meet the target moisture of 10% water by weight using a series of pressing and air blowing steps. After the desired filtration time, the filter press will open, and discharge zinc concentrate to the zinc concentrate bagging system via the zinc concentrate discharge screw conveyor. Following discharge of concentrate, the filter cloth will be manually washed on an as needed basis.

Zinc concentrate discharging to the zinc concentrate bagging system will be manually sampled for metal accounting purposes. Concentrate mass will be determined by the bagging system weigh scale.

17.3.10 Tailings Thickening and Filtration

Tailings from the zinc rougher-scavenger flotation circuit are pumped to the tailings thickener where flocculant is added to promote thickening of the tailings.

Thickener overflow gravitates to the tails thickener overflow tank from which it is pumped to the process water tank by the duty/standby tails thickener overflow pumps. Thickener underflow is pumped to the agitated tails filter feed tank which provides surge capacity between the thickener and filter.

Tailings are pumped in discrete batches to the tailing filter, which filters the concentrate to about 20% moisture. After the desired filtration cycle time, the filter press opens and discharges the filtered tailings to the floor of the filtered tails storage bunker. Following discharge of the filtered tails, the filter cloths are washed automatically by the filter cloth wash system prior to the next cycle using raw water from the cloth wash tank. Filtrate from the tails filter is pumped to the tailings filtrate water tank and then pumped to the tails thickener or alternatively to the process water tank.

A front-end loader is utilized to remove filtered tails from beneath the filter presses and loaded onto 25 ton articulated trucks. The trucks dump onto the dry stack tailings impoundment and, in the process, compact the tailings.

Filtered tails are manually sampled for metal accounting purposes. A count of the number of filter cycles completed provides an estimated tails mass for metal accounting. A sump pump is provided to return spillage to the tails thickener or tails filter feed tank.

17.3.11 Reagent Mixing, Storage and Distribution

Xanthate (sodium isopropyl xanthate), copper sulfate, zinc sulfate, and depressant (sodium metabisulfite) are delivered in solid form in either drums or bulk bags and stored in the new reagents building. Process water is added to the agitated reagent mixing tank. Bags are lifted manually into the bag breaker, located on top of the tank. The solid reagent discharges into the tank and dissolves in water to achieve the required dosing concentration. The mixed solution is then transferred to the storage tank using the transfer pump. Both the mixing and storage tanks are covered and ventilated. From the solution storage tank, reagent solution is pumped to a day-tank in the plant. Peristaltic pumps are used to distribute reagent solution from the day-tank to the flotation circuit at a controlled rate. SMBS flow rate is measured by a rotameter.

Frother (MIBC) and promoter (Aero 242) are delivered in liquid form in drums or totes. A pump transfers liquid reagents from the drums or totes to the respective transfer tanks and then to the respective reagent header tanks. The Aero 242 solution requires additional dilution with water to meet the flow requirement for distribution within the plant. Peristaltic pumps distribute the MIBC solution and the Aero 242 solution from the day-tank to the flotation circuit at a controlled rate. Flow rates are determined at the pump control box or through the control system.

Collector (Aero 3418A) is delivered in liquid form in totes. A drum pump is used to transfer the liquid reagents from the tote to a reagent header tank. Aero 3418A requires additional dilution prior to the header tank. Peristaltic pumps distribute the reagent solution from the header tanks to the flotation circuit at a controlled rate. Flow rate is determined at the pump control box or through the control system.

Flocculant is delivered as a 2% liquid in totes. A drum pump is used to transfer the liquid flocculant from the tote to the flocculant mixing tank. Process water is added to the agitated mixing tank to achieve the required flocculant dosing concentration (0.2%). From the mixing tank, dedicated variable-speed metering pumps distribute flocculant to the respective concentrate and tailings thickeners. Flow rate is determined at the pump control box or through the control system.

Hydrated lime is delivered in solid form in bulk bags and stored in the reagent shed. Process water is added to the agitated mixing tank. Lime bags are then lifted into the bag breaker via a dedicated lime hoist and the lime is transferred by screw conveyor to the mixing tank. The solid lime discharges into the tank and dissolves in water to achieve the required dosing concentration. The mixed solution is then transferred to the storage tank using the transfer pump. Milk of lime solution is delivered to the flotation circuit using the circulating pumps in a pressurized-ring piping system. Actuated valves at the process lime dosing points are utilized to adjust lime addition to the circuit, as required. The milk of lime addition to the flotation circuit is adjusted based on a targeted pH level determined by the process operation team.

17.3.12 Raw Water Storage and Distribution

Raw water is supplied from a local raw water source and stored in the plant raw water tank. The raw water is used for the following duties:

- Gland water
- General distribution in the crushing area
- Process water make-up

17.3.13 Process Water Storage and Distribution

Process water is stored in the process water tank. Process water is provided by tailings thickener overflow, tailings filter filtrate, as well as makeup water from the raw water storage and distribution system. Process water is used in most areas of the plant to control slurry density, and to enhance the gravity flow at mill discharges and flotation froth troughs. A pressurized process water loop provides water to the various locations through a piping network and manual/automatic control or on/off valves.

Process water is used for process stream dilution, hopper-level control and froth breakdown, froth washing, reagent mixing, and general plant wash down and housekeeping requirements.

The lead concentrate thickener overflow and zinc concentrate thickener overflow are pumped to the filtrate water tank and commingled with the tails filtrate water. A filtered water plant will be designed post-startup from actual plant data that will eventually allow this water to be discharged into the bio reactive water treatment system. Though not required during startup or for continuous operations, the water treatment plant is expected to be operational within six to eight months from plant startup.

17.3.14 HP and LP Air Services

The existing air compressors are utilized to supply high pressure to the mining operation only. Plant and instrument air are delivered by new duty/standby air compressors. A portion of the high-pressure air supply is dried to suit instrumentation air requirements.

The existing, dedicated, low-pressure air blowers provide air to the flotation circuit. A new air blower is provided to supply the additional air required by the expanded flotation circuit.

17.4 Plant Design and Equipment Characteristics

Between January and May 2017, Barr completed final process design, and developed detailed mechanical, structural, and electrical documents (drawings and specifications), issued for construction. The technical documents were developed using production rates from the final process design and input from OSMI regarding preferred equipment vendors. Some components were already purchased by OSMI and were incorporated into the design, including:

- The secondary crusher
- The rod mill and associated equipment
- The wet screens for closed circuit around the ball mill

Detailed drawings, equipment list, technical specifications, and the related documents required for the process plant upgrade to be installed have all been delivered to OSMI.

17.5 Consumable Requirements

The main consumables for the Project include electricity, process reagents, process water, and other process consumables (crusher liners, mill liners, grinding media and filter cloth media).

17.5.1 Electrical Power

The electricity for the process plant is supplied from the existing grid system with access to an emergency generator when needed. The projected electricity consumption of the process plant is shown in Table 17-2.

The average operating load is computed by multiplying the installed non-redundant load by a demand factor. Typically, the demand factor is determined from operating records, but no such records could be obtained for this report. The PFS study demand factor of 0.8 (Lycopodium, 2016) was therefore assumed and applied to all loads in the processing plant. An added demand factor was applied in the processing areas 200 to 800 in Table 17-2 to reflect that the maximum load column is for the plant operating to produce 91,000 mt/y (100,310 st/y), but the values in this report are based upon 91,390 st/y. The revised factor is therefore $0.8 * 91,390/100,310 = 0.73$.

The electrical power consumption is based on the average operation load multiplied by the annual operating hours assumed for each portion of the plant. The assumptions for operating hours listed in the Lycopodium report were used and are as follows:

- Crushing and milling – 7,008 hours per year or 80% utilization
- Flotation – 8,059 hours per year or 92% utilization
- Filtration and bagging – 7,446 hours per year or 85% utilization
- Other loads – 8,059 hours per year or 92% utilization

The connected power for the processing plant at the OSMI is 5.2 MW while the average continuous power draw is 2.1 MW.

Table 17-2: Summary of the Power Consumption Rates per Processing Plant Area (Based on 91,390 st/y)

Area	Installed Load (kW)	Maximum Load (kW)	Demand Factor	Annual Average Operation Load (KW)
200 Area Transformer	600	440	0.73	321
300 Area Transformer	1,313	990	0.73	721
500 Area Transformer	406	250	0.73	182
800 Area Transformer	408	204	0.73	149
Total	2,727	1,884		1,373

Source: Barr, 2018

17.5.2 Reagents

Reagent types and dosage were determined through laboratory testing which was provided to Barr for use in process modeling and flowsheet/mass balance (FLSmith, 2016; FLSmith, 2017a; FLSmith, 2017b). The reagents for the processing plant include:

- Hydrated Lime: Milk of lime is added to the zinc flotation circuit for adjustment to the operating pH of the flotation slurry.
- Xanthate: Sodium isopropyl xanthate (SIPX) is a collector that is used in the zinc flotation to promote the flotation of zinc sulfides into the zinc concentrate.
- Aero 242: A collector/promoter that is added to the lead rougher flotation circuit to enhance the flotation of silver and gold-bearing minerals into the lead concentrate.
- Aero 3418A: A collector/promoter that is added in the lead flotation circuit for the flotation of lead, copper, silver- and gold-bearing minerals and is highly selective against iron minerals in the ore.
- MIBC: Methyl isobutyl carbinol is used as the frother for both the lead and zinc flotation circuits.
- Flocculant: An anionic flocculant is used in the lead concentrate; zinc concentrate and tails thickeners. The same flocculant is used in each system.
- Sodium metabisulfite (SMBS): SMBS is utilized as a depressant for iron sulfide minerals in the zinc flotation circuit and is added to the ball mill (or rod mill) for slurry conditioning.
- Copper sulfate: Added to the zinc flotation circuit as an activator for the zinc mineral (sphalerite).
- Zinc sulfate: Added as a depressant that reduces the activation of sphalerite during lead flotation. Zinc sulfate is added to ball mill for conditioning prior to lead flotation circuit.

Anticipated reagent usage is shown in Table 17-3.

Table 17-3: Reagent Usage (Based on 91,390 st/y)

Consumables	Consumption (Per st of Rod Mill Feed)	Annual Consumption	Source
Hydrated Lime	4.30 lb	392,977lb	Testing
Xanthate (SIPX)	0.04 lb	3,656lb	Testing
Aero 242	0.01 lb	914lb	Testing
Aero 3418A	0.02 lb	1,828lb	Testing
MIBC – Frother	0.11 lb	10,053lb	Testing
Flocculant – Pb Thickener	1.07 g	216lb	Barr
Flocculant – Zn Thickener	0.42 g	85lb	Barr
Flocculant – Tails Thickener	21.7 g	4,372lb	Barr
Sodium Metabisulfite	0.525lb	47,980lb	Testing
Copper Sulfate	0.26 lb	23,761lb	Testing
Zn Sulfate	0.525 lb	47,980lb	Testing

Source: Barr, 2017

17.5.3 Process Consumables (Major Sources)

Certain materials are consumed in the process. These are primarily wear parts, grinding consumables, and filter cloths, as listed below and shown in Table 17-4:

- Jaw crusher liners
- Rod mill liners and grinding rods
- Ball mill liners and grinding media
- Filter cloth for filtering concentrates

Table 17-4: Process Consumables Usage (91,390 st/y)

Consumables	Consumption (Per st of Rod Mill Feed)	Annual Consumption	Source
#1 Jaw Crusher Fixed Liner		3.5 sets/yr	Lycopodium
#1 Jaw Crusher Moving Liner		2 sets/yr	Lycopodium
#2 Jaw Crusher Fixed Liner		3.5 sets/yr	Lycopodium
#2 Jaw Crusher Moving Liner		2 sets/yr	Lycopodium
Rod Mill Liners		0.7 sets/yr	OSMI
Rod Mill Grinding Media	0.9 lb	90,810 lb	Barr/OSMI
Ball Mill Liners		0.5 sets/yr	OSMI
Ball Mill Grinding Media (forged)	0.8 lb	80,700 lb	Barr/OSMI
Filter Cloth Conc. (3 Units)		12 sets/yr	Lycopodium
Filter Cloth Tailings (2 Units)		8 sets/yr	Lycopodium

Source: Barr, 2017

17.6 Process Plant Performance

Commissioning of the redesigned process plant was initiated during September 2021 and continued intermittently to December 15, 2021. During this period only the lead flotation circuit was operated (the zinc flotation circuit was not operated) and approximately 1,819 tons of ore was processed at an estimated average feed grade of 3.33% Pb, 2.50% Zn, 10.39 oz/t Ag and 0.027 oz/t Au. Plant performance during this commissioning period is summarized in Table 17-5. Plant performance continued to improve during commissioning but fell far short of expectations. During December, 52.4% of the Pb, 13.3% of the Ag and 24.8% of the Au was recovered into lead concentrates that averaged 39.18% Pb, 110.8 oz/t Ag and 0.344 oz/t Au. During this period, the plant was operated at about 150

tons/day, significantly below design capacity of 270 tons/day. Actual plant performance during this period can only be considered an estimate for the following reasons:

- Plant feed tons were determined by rail car count as the plant feed weightometer had not yet been installed. An estimated moisture content of 25% was applied to all plant feed.
- Feed grade was determined by the geology department as no plant feed samples were taken. concentrate production was based on actual weights and assays performed by an independent commercial laboratory.
- Estimated metal recoveries were based on actual concentrate production and estimated plant feed tons and grades.

Table 17-5: OSM Concentrator Commissioning Performance (September - December 2021)

Ore To The Mill ⁽⁴⁾					Estimated Feed Grade ⁽²⁾				Lead Concentrate Grade ⁽¹⁾				Lead Conc.	Tails	Recovery (%) ⁽³⁾			
Mill Feed	Month	Tons Ore	Moisture	Dry Tons Ore	Pb %	Zn %	Ag opt	Au opt	Pb%	Zn%	Ag opt	Au opt	Dry Tons	Dry Tons	Pb	Zn	Ag	Au
Stopes & Stockpile	Sept	300	25%	225	0.50	1.20	3.50	0.010	7.76	5.48	24.50	0.124	0.96	224	6.6	2.0	3.0	5.3
Stopes & Stockpile	Oct	1,800	25%	1,350	3.55	2.47	10.21	0.030	15.21	8.06	47.17	0.201	20.69	1329	6.6	5.0	42.5	61.8
Stopes & Stockpile	Nov	200	25%	150	5.01	4.09	16.35	0.027	31.69	12.36	98.99	0.281	7.87	142	33.2	15.8	21.2	36.9
Stopes & Stockpile	Dec	125	25%	94	4.33	3.59	20.11	0.033	39.18	12.40	110.77	0.344	5.42	88	52.4	20.0	13.3	24.8
Totals		2,425	25%	1,819	3.33	2.50	10.39	0.027	16.88	8.32	51.92	0.21	34.95	1784	12.9	7.4	21.1	37.1

Source: OSMI 2022

Notes:

¹ Concentrate analyses by Hazen

² Feed grades estimated by geology - no plant feed grades were obtained

³ Recovery to Lead Concentrate

⁴ All Production reported in short tons

17.7 SRK Site Visit

SRK made a site visit to the process plant on December 16, 2021 (during which time the plant was not running) and makes the following observations and recommendations regarding the current commissioning status of the concentrator.

17.7.1 Run-of Mine (ROM) Ore Storage

- The ROM ore dump pocket was originally designed for 270 t of ore but was constructed with only 120 t of storage capacity.
- Ore haulage will have to be carefully planned to avoid concentrator interruptions or shutdowns due to a lack of ore.
- There is no opportunity for ore blending at the concentrator, as such, any ore blending that can be done will have to be done in the mine.

17.7.2 Primary and Secondary Crushing

- There is extreme carry-back on the apron feeder that feeds the primary crusher. OSMI is installing a scraper and diverter chute to control the carry-back. It is not certain that this will be sufficient to fully control carry-back.
- The primary crusher (Metso C80) has experienced some plugging when being fed at half capacity, which will likely become a greater problem when being fed at full capacity.
- The primary crusher is currently operated with a 2-inch closed side setting (CSS). It is recommended that the CSS be increased to 2.5 inch in an attempt to reduce the potential for plugging. In addition, the speed of the crusher should be checked. It is designed by the manufacturer to operate at 350 rpm. Additionally, OSMI should take measures to reduce the moisture content of the ore being fed to the crusher. As noted in Section 17.6, the moisture content of the ore during commissioning was estimated at 25%, this is far too high for primary crushing.
- The scalping vibrating screen, which screens the primary crusher discharge, blinds off continually and is a significant source of process interruption and downtime. The polyurethane screen deck has approximately 3/4-inch square openings. It is recommended that the screen decking be changed to provide a slot-style opening with a greater open area. In addition, the amplitude and pitch of the screen should be checked and adjusted to provide the maximum amplitude and pitch recommended by the manufacturer.

17.7.3 Rod Mill Circuit

- The 6 ft x 11 ft rod mill is driven by a 150 hp motor and variable speed drive and is operated in open circuit at a slurry density of about 50% solids. SRK notes that rod mill grinding should be conducted at about 70 to 74% solids and that grinding at 50% solids is very inefficient. The low rod mill slurry density has been adopted to OSMI to provide sufficient volume and line velocity to pump the rod mill discharge to the ball mill circuit.
- SRK makes the following recommendations regarding the rod mill circuit:
 - Rod mill grinding should be conducted at about 70 to 74% solids and any dilution water that is required to achieve pumping line velocity should be added to the rod mill discharge box.

- OSMI should conduct screen analyses on the rod mill feed and discharge to assess grinding performance.
- Rod mill feed should be sampled on a regular basis. A new weightometer and cross-belt sampler have recently been installed on the rod mill feed conveyor but have not yet been used.

17.7.4 Ball Mill Circuit

- The ball mill circuit consists of an 8 ft x 12 ft ball mill driven with a variable speed 400 hp motor operated in closed circuit with two Derrick Stack Screens. The screen oversize is ball mill feed and the screen undersize is flotation feed.
- During commissioning it was found that the 105 mesh (approximately 150 µm) screen deck originally installed on the Derrick Stack Screens would blind off. As such, the screen deck was replaced with an 80 mesh (approximately 180 µm) screen.
- No screen analyses have been conducted on the flotation feed and the particle size distribution in the feed to flotation is not known.
- SRK makes the following recommendations regarding the ball mill circuit:
 - Screen analyses on the flotation feed should be conducted on a regular basis to ensure that the target grind of 80% passing (P80) 130 µm is being achieved.
 - An automatic sampler should be installed on the flotation circuit feed and set to cut a sample every 15 minutes.
 - The screen manufacturer (Derrick) should be consulted to determine why the originally installed 105 mesh screen blinds off. High frequency Derrick screens should be able to easily screen feed at the design mesh of separation. The use of a coarser screen will result in a coarser grind size than designed. The coarser grind size will result in lowering achievable metal recoveries.

17.7.5 Lead-Copper Rougher Flotation

- The lead-copper rougher flotation circuit consists of a new 106 ft³ agitated rougher conditioning tank followed by a new, single 177 ft³ tank-type flotation cell and six existing 60 ft³ trough-type flotation cells in series. Derrick screen undersize flows by gravity into the rougher conditioner tank and is then advanced to the lead rougher flotation circuit.
- The flotation circuit has been operated substantially below capacity (approximately 150 tph versus design at 270 tph) and has experienced frequent upsets that have limited the ability for the circuit to achieve steady-state operating conditions.
- Metal recoveries and concentrate grades have been significantly below target.
- OSMI has moved the addition point for the zinc mineral depressants (zinc sulfate and sodium metabisulfite) from the ball mill circuit to the rod mill circuit to allow for more conditioning time prior to addition of the lead-copper flotation collectors (Aerophine 3418 and Quadra 3670). SRK believes that this is a positive move.
- Lead-copper flotation collectors appear to have been added at much higher dosages than design, which has resulted in lower concentrate grades and higher zinc distribution into the lead-copper concentrate.
- The lead-copper rougher circuit has recently been operated using only the new 177 ft³ tank cell and bypassing the six 60 ft³ flotation cells.

- SRK makes the following observations and recommendations regarding the lead-copper rougher flotation circuit:
 - Operating only the single 177 ft³ tank cell during rougher flotation will result in significant slurry bypassing and reduced retention time, which will result in significantly lower metal recoveries into the lead-copper concentrate.
 - It is recommended that the six existing 60 ft³ flotation cells be put back into to service in order to minimize slurry bypassing and achieve design flotation retention time.
 - Reagent addition and conditioning does not appear to be optimized.
 - It is recommended that OSMI continue to add zinc sulfate and SMBS at the rod mill and carefully control collector addition. It is suggested that approximately 50% of collector be added to the conditioning tank and that the balance of the collector be stage-added at several points to the rougher flotation circuit.
 - Frother should be stage-added as required to the flotation circuit.
 - An automatic sampler should be installed to sample the final tailings.

17.7.6 Lead-Copper Cleaner Flotation

- Upgrading of the bulk lead-copper rougher concentrate was designed to include two stages of cleaning. The first-stage lead-cleaner flotation circuit consists of one, new, 177 ft³, tank-type flotation cell and two, existing, 16 ft³, trough-type flotation cells in series. Similarly, the cleaner scavenger circuit was designed to include one 177 ft³ flotation cell (not installed) and two (existing) 16 ft³ trough-type flotation cells in series. The second stage cleaner circuit consists of one column flotation cell.
- As designed, the concentrate from the lead-copper rougher flotation circuit was to be pumped to the first stage lead cleaner tank cell, and the cleaner-1 concentrate was to be pumped to the column cleaner circuit. Cleaner-1 tails would then gravitate to the second stage cleaner-scavenger cells. The cleaner-scavenger concentrate would be pumped to the column cleaner circuit along with the cleaner-1 concentrate, and the cleaner-scavenger tailing would be pumped back to the lead flotation conditioners. Column cleaner concentrate would be final concentrate and pumped to the lead concentrate thickener. Cleaner-2 tails would be pumped back to the first stage cleaner.
- OSMI has significantly altered the cleaner circuit. The lead-copper rougher concentrate is upgraded in the first new tank cell and all other stages of cleaner flotation are eliminated, or bypassed. The cleaner-1 concentrate from the tank cell is final concentrate and the cleaner-1 tailing would be advanced to the zinc flotation circuit (which has not yet been operated).
- OSMI has indicated that the cleaner column flotation circuit has been problematic and difficult to control.
- SRK makes the following observations and recommendations regarding the lead-copper cleaner flotation circuit.
 - The modifications made to the lead-copper cleaner flotation circuit are not consistent with the process design and will result in both low metal recoveries and concentrate grades.
 - SRK suggests that the originally designed cleaner circuit be modified to conform more closely to the flowsheet used during the metallurgical development program and include two to three stages of mechanical cell cleaner flotation and eliminate the cleaner column flotation cell that has been problematic.

- The three stage cleaner circuit should be setup such that:
 - The lead-copper rougher concentrate is pumped to the first-stage cleaner
 - The first-stage cleaner concentrate is advanced to the second-stage cleaner, and the first-stage cleaner tailing is advanced to the cleaner-scavenger.
 - The cleaner-scavenger concentrate is recycled back to lead-copper rougher flotation and the cleaner-scavenger tailing is recycled back to the lead conditioner or advanced to the zinc circuit conditioner (depending on lead content).
 - The second-stage cleaner concentrate is advanced to the third-stage cleaner, and the second-stage cleaner tailing is cycled counter-currently back to the first-stage cleaner.
 - The third-stage cleaner concentrate is final concentrate that is sent to the lead-copper concentrate thickener and the third-stage cleaner tailing is cycled counter-currently back to the second-stage cleaner.
- There are unused flotation cells that had originally been installed for the lead-copper separation circuit (lead-copper separation is not included in current flowsheet) that could possibly be used for the third-stage mechanical cleaner flotation circuit.

17.7.7 Zinc Rougher Flotation

- The zinc rougher flotation circuit has not yet been operated or commissioned.
- Recommendations made for the lead-copper rougher circuit generally apply to the zinc rougher flotation circuit.

17.7.8 Zinc Cleaner Flotation Circuit

- The zinc cleaner flotation circuit has not yet been commissioned.
- Recommendations made for the lead-cleaner flotation circuit generally apply to the zinc cleaner flotation circuit.

17.7.9 Lead Concentrate Thickening and Filtration

- The lead concentrate is thickened in a conventional thickener and filtered on a batch basis in a plate and frame pressure filter. OSMI has not experienced any problems with lead concentrate thickening and filtering.

17.7.10 Tailing Thickening and Filtration

- The flotation tailing is thickened in a 27 ft diameter high-rate thickener to about 50 to 55% solids using AF 309 flocculant, and then filtered in two plate and frame pressure filters (1,500 mm x 40 plates) to a target moisture content of 15%. OSMI has not identified any current issues related to tailing thickening and filtration. It is noted that the thickener is operated manually and does not have required instrumentation installed to operate automatically. This could become a concern when the plant is being operated at full design capacity.

17.7.11 Process Water Recycle

- The lead concentrate, zinc concentrate, and flotation tailings are thickened and filtered with the thickener overflows and filtrates recycled to a single process water tank. Process water from the process water tank is then distributed throughout the plant. This arrangement does not allow for the isolation of process water from the lead flotation circuit and the zinc flotation

circuit. This is problematic as it allows for the introduction of zinc flotation reagents into the lead flotation circuit and could result in the activation of zinc and iron minerals (sphalerite and pyrite) during lead flotation. This could result in lower grade lead flotation concentrates along with flotation of zinc minerals into the lead concentrate resulting in lower recovery of zinc minerals. This is of more concern for the OSMI concentrator where the flotation tailings are thickened and filtered in the concentrator and most of the process water is immediately recycled back to the process water tank rather than being discharged to a conventional TSF where the process reagents are allowed to age prior to being pumped back to the concentrator.

- This issue has not yet been encountered due to the fact that the zinc flotation circuit has not yet been commissioned.
- If during commissioning it is found that the commingling of lead and zinc flotation process water streams does in-fact result in deterioration of flotation performance, it is recommended that the circuit be modified to keep these flow streams isolated. This could be accomplished by installing a thickener after the lead rougher/scavenger flotation circuit to thicken the lead scavenger tailing and receive lead concentrate thickener overflow and lead concentrate filtrate streams. The thickener overflow could be recycled back to a separate lead flotation process water tank and the thickener underflow could be advanced to the zinc flotation conditioner tank.

17.7.12 Analytical/Metallurgical Laboratory and Personnel

- OSMI is installing an analytical laboratory that will have the capability to make ICP determinations for lead, copper, zinc and silver values and fire assay determinations for gold values for concentrator and mine samples. However, OSMI does not have analytical technicians or a metallurgical engineer experienced in polymetallic flotation on staff and there is no metallurgical laboratory in which routine flotation process testwork can be conducted.
- It is highly recommended that an experienced metallurgical engineer be hired to provide direct technical and operational management of the concentrator. In addition, metallurgical laboratory should be installed and staffed with the capability of conducting routine metallurgical testwork to provide guidance for the operation of the concentrator under variable feed conditions.

18 Project Infrastructure

18.1 Off-site Infrastructure and Product Logistics

The mine has operated in the past and has existing off-site infrastructure including a 15,000 ft² warehouse with office space for administration located in the town of Ouray. Additional administrative offices in town have been added to support the ongoing operation. A laboratory has been added to the offsite infrastructure co-located with the existing Ouray warehouse. The maintenance and upkeep of the off-site infrastructure is included in the Project budget. The existing fueling system at the warehouse has been upgraded during the restart construction project.

The Project is located in southwestern Colorado near the town of Ouray, in Ouray County. Ouray is approximately 335 highway miles or approximately 5.5 hours by road southwest of Denver via Interstate 70 and US Highways 50 and 550. Ouray (population 1,100) is an established community with a history of mining and combined with the additional communities of the Town of Ridgway and City of Montrose has all necessary housing and infrastructure to support the operation. Other proximate communities that could support the Project include Delta (population 9,000) located 59 miles north of Ouray and Grand Junction (population 60,000) located 97 miles north of Ouray. Industry to support the mining Project is available in all the larger communities including mining related supplies in Grand Junction and Durango, CO.

The nearest airport with scheduled service is the Montrose Regional Airport, located approximately 40 miles north of Ouray. A larger airport is available in Grand Junction.

There are experienced mining personnel in the region capable of providing staffing for the Project. The region of Colorado where the Project located is a desirable location for personnel to live.

18.1.1 Mine Access Road

Access to the mine site is via U.S. highway 550 south from Ouray approximately one-quarter mile and thence an existing improved all-weather gravel road designated Ouray County Road 361 for 5 miles. Ouray County Road 361 becomes Ouray County Road 26 for the last 1.3 miles. The mine under contract with Ouray County and the USFS maintains the road to the site year-round. The County also assists with maintenance including dust suppression, signage and policing due to the significant tourist traffic accessing the high mountain roads of Yankee Boy and Imogene Basins. Figure 18-1 shows a photograph of winter access to the site.



Source: OSMI, 2017

Figure 18-1: Photograph of Winter Access Road

During winter months, both the USFS and County allow the mine to lock the road at Senator Creek approximately halfway to Ouray. This restricted access is required due to the need to both maintain the road properly but also to allow avalanche mitigation following heavy snowfalls.

Figure 18-2 shows the Alpine Safety Operating Plan – Regional Slide Paths.

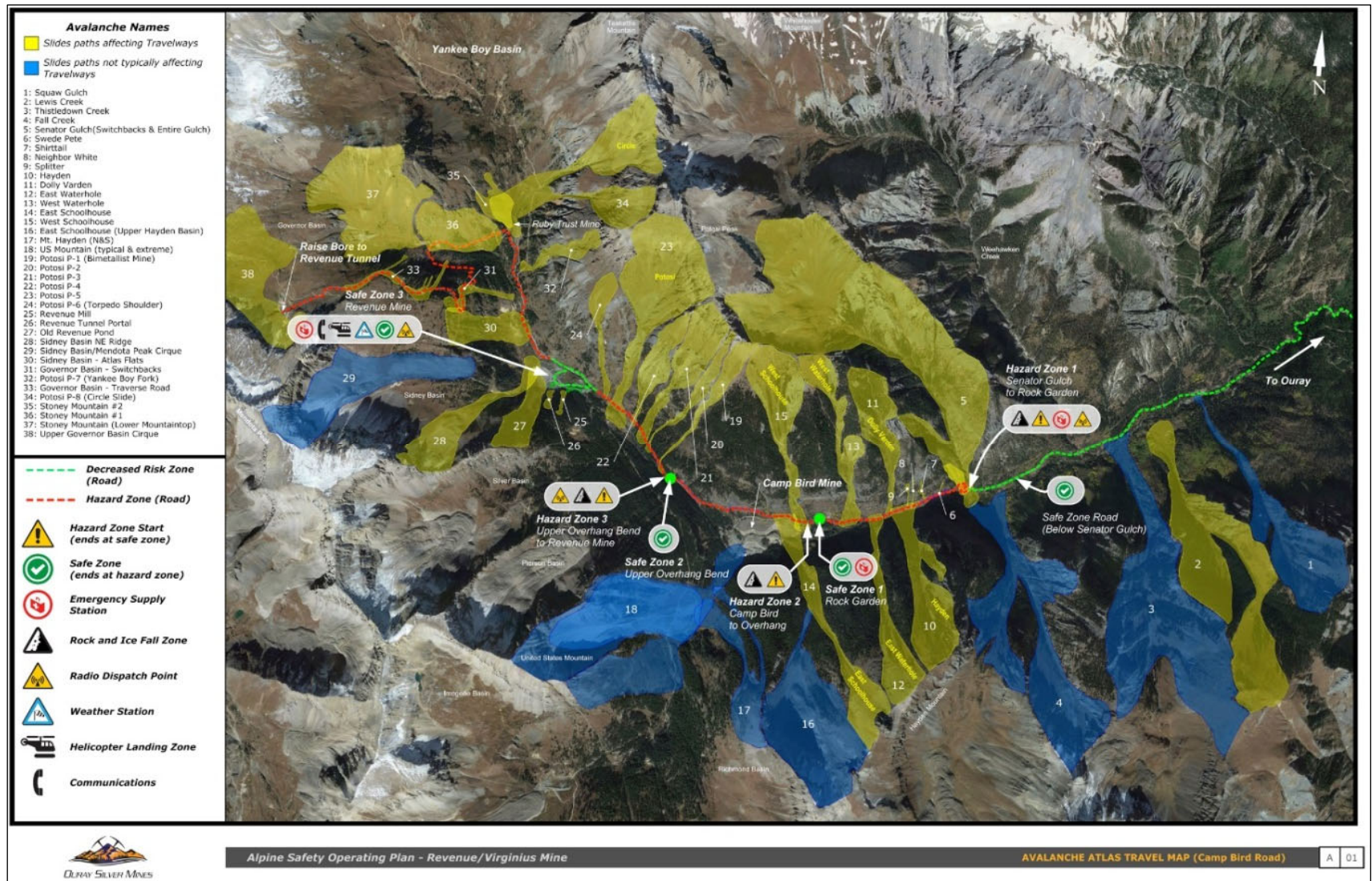

Source: OSMI, 2017

Figure 18-2: Alpine Safety Operating Plan – Regional Slide Paths

As noted above, the road is heavily traveled during the summer tourist season and is steep and narrow in many places requiring the use of 4WD vehicles for a good portion of the year. Vehicle heights are limited by overhung rock formations and must be verified prior to shipping to the site.

Figure 18-3 shows a photograph of the access road and the height limit for the road in the rock overhang.



Source: OSMI, 2017

Figure 18-3: Photograph of the Access Road and the Height Limit for the Road in the Rock Overhang

18.1.2 Off-site Warehouse and Offices

The Project includes an existing administrative and warehouse building, laydown yard, and parking located on the north end of Ouray on U.S. Highway 550. The facility is approximately 15,000 ft² with a reception area, six offices, and heated warehouse area with two loading docks with adjustable hydraulic ramps for loading/unloading semi-trailers. The warehouse and yard allow for storage of product concentrate, materials, equipment, and supplies. Warehoused items are moved to the mine as needed by mine personnel.

Additional office space has been obtained in Ouray to support ongoing operations.

Figure 18-4 is a photograph of the facility from the north looking south and Figure 18-5 shows a plan view of the facility.



Source: SRK (Google Earth), 2016

Figure 18-4: Ouray Administrative/Warehouse Building and Yard (Street View)

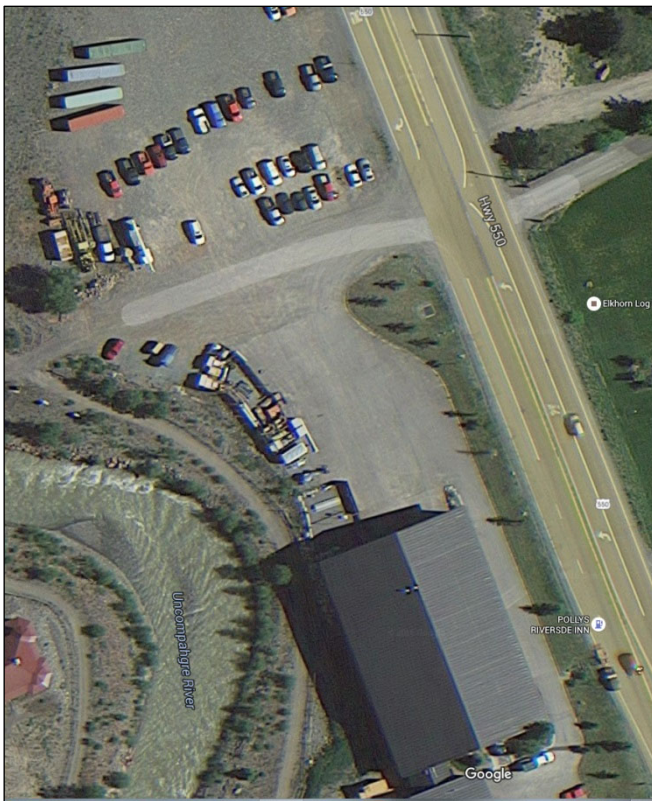

Source: SRK (Google Earth), 2016

Figure 18-5: Ouray Administrative/Warehouse Building and Yard

18.1.3 Product Logistics

Once in full production, OSMI will be producing up to 30 super sacks (4,000 lb each) of various concentrates (current plan for lead and zinc, future potential for a copper concentrate) per day. OSMI will transport the super sacks from the mine to the Ouray warehouse. The concentrate will be aggregated in the warehouse and then shipped by a contracted carrier to the buyer. OSMI will transport the sacks by truck with four sacks per truckload, 7 loads on average per day. A forklift is available at

the warehouse and on the Project site to load the sacks. An over-the-road contractor will transport the product to the designated buyer. There are multiple options for OSMI concentrate to be purchased. The cost for shipping lead concentrate is approximately US\$181/wmt and US\$159/wmt for zinc concentrate. An additional US\$27/wmt is added for weigh/assay/insurance. Lead concentrate shipment price is estimated higher than zinc for conservatism to allow for longer shipment routes to optimize concentrate terms given lead concentrate is the largest economic driver.

18.2 On-Site Infrastructure

18.2.1 Introduction

The majority of the Project site surface and underground infrastructure currently exists and adequately supports current development operations. Specific upgrades to Project facilities completed during the previous preproduction period included:

- Increasing backup generator size to 3.0 MW to allow full operations to continue in the event that line power is interrupted during the winter and adding a facility to house the generator
- Improving and upgrading the current electrical system
- Expanding the existing administrative building and changehouse
- Adding a covered railyard and warehouse facility at the mine portal
- Updating the surface crusher/screen system
- Rehabilitation of the run-arounds in the main haulage drift to allow sidings and create direct line transport of muck to the mill or waste dump wall
- Construction of a genset and transformer building
- Updating the compressed air system for both mine and mill with additional capacity and replacing supply lines
- Adding miscellaneous facilities to support warehousing, utilities and maintenance
- Updating the IT and communications systems for the mine site and warehouse

The existing surface facilities, as shown in Figure 18-6, include tailings storage areas, tailings thickener, administrative building and changehouse, milling facilities both underground and on the surface. Other facilities not shown include, a second TSF, rail system and car unloader, emergency generator, diesel storage tank, warehouse and shops. The site has several laydown and storage areas. The process facility is located underground adjacent to the mine portal.



Source: OSMI, 2016

Figure 18-6: Existing Surface Infrastructure

The underground infrastructure includes a portal, 7,800 ft of main tunnel back to the #1 shaft, track haulage system, mine power system tied to the backup generator, mine ventilation system, ventilation borehole (Hubb Reed raise) and existing emergency hoist system, compressed air system, mine drainage ditches and pumps, and underground powder and primer magazines, communications systems (both surface and underground), and water supply pumps and sump. Communications with the warehouse in Ouray currently is via both CenturyLink data line for voice and internet as well as two-way radio. As part of current improvements, a satellite uplink was installed to further enhance communications. A leaky feeder system was installed underground to improve communications between surface and underground. The leaky feeder system can remotely operate the backup generator and fan controls.

The Project has remaining improvements and additions to the infrastructure. Figure 18-7 shows the location of the projected additions to the Project, which include:

- An enclosure for the thickener
- Lab addition
- Upgrade power inputs from the utility to improve reliability
- Two pole barns for storage
- Development of a winter tailings storage area (also referred to as Atlas or Western storage area)

- Rehabilitation of the #1 Shaft and hoist (in year two of operation)



Winter tailings storage is the Revenue or eastern storage pile, and Atlas Summer tailings storage is the western storage pile.
Source: OSMI, 2017

Figure 18-7: Planned Surface Infrastructure

18.2.2 Access

The mine access at the site is by improved gravel road and enters the property over a gated, single lane, 24-ton bridge that crosses Sneffels Creek from Ouray County Road 26 on to the east side of the Project property. The gravel road provides access to all the facilities on site.

18.2.3 Plant

The plant facilities and proposed modifications are discussed in detail in Section 17. The process facility is located underground adjacent to the mine portal.

18.2.4 Solid Waste Handling

Waste Rock

Mine waste rock is stored temporarily in the yard in front of the dump wall where an existing crushing and screening operation is in place to create road base that is used on site and on the County road accessing the mine. The remainder of the waste rock is mixed, per permit, with tailings and stored in the TSF. The waste crusher facility is designed to crush up to 75 t/h. Some of the equipment to build

this facility is coming from the deconstruction of the existing underground crusher plant. The waste crusher setup will include a primary jaw crusher that is capable of crushing down to 1.5-inch minus, a single deck vibrating screen, and a 3-foot short head cone crusher capable of crushing down to ½ inch minus.

The Project received a State permit approval in April 2017 to sell a waste rock – tailings blend as road base. It is expected that as much as 30% of the tailings and all the waste rock will be sold to the various municipalities, contractors and government agencies. In the past, all waste rock produced by the mine site has been used by Ouray County to improve County Road 361.

Sanitary Septic System

The site has two approved installed septic systems that handles the site sewage. The underground sanitary waste will be handled by adding automatic decomposing toilets.

Other Waste

Nonhazardous waste such as steel is generally recycled. A local company provides recycling dumpsters and removes the scrap steel. In the past, OSMI has received payment for this, but it depends on the scrap steel market. Other nonhazardous waste such as wood and paper will be burned in a permitted burn area located on site upon receipt of a Colorado Department of Public Health and Environment (CDPHE) permit. OSMI will use local approved landfills for all other materials as necessary.

The site is classified as a Very Small Quantity Generator per the CDPHE Hazardous Materials and Waste Management Division and generates very little hazardous waste. Items such as waste oil and ballast from fluorescent lights and any reclaimed reagents make up the most of Project hazardous waste. These items are placed in environmentally safe containers and disposed of by various companies such as Waste Management and Heritage Environmental Services.

18.2.5 Emergency Hoist

The underground mine has an existing 8 ft diameter borehole used for ventilation and emergency egress. An emergency hoist system with a diesel generator driven hoist, headframe, man-cage, and storage sea container is located on the surface in Governor Basin. The raise location on surface is approximately 0.7 miles line of site from the mine, but road access is approximately 3 miles over an unimproved mountain dirt road. The system will be modified and replaced during the development period with an elevator system (Century Elevator scope) that can be accessed and maintained from either the underground workings or the surface. The system will be a significant upgrade and will eliminate access issues to maintain the emergency escape hoist.

An additional backup generator that is included in the Century Elevator scope will be installed underground to run both the #1 Shaft and ventilation raise in case the main power line from surface to underground is damaged. The surface access to the existing hoist can be challenging during severe weather events and the new system will upgrade the effectiveness of the existing system as well as provide access to development and exploration on levels above the existing 2000 level. Figure 18-8 includes photographs of the existing emergency hoist system that will be replaced.



Source: SRK, 2016

Figure 18-8: Emergency Hoist and Headframe Photos

18.2.6 Water Systems

Service Water

Service water for the mine, mill, and surface operations is supplied by groundwater infiltrating into the mine workings. The infiltrated groundwater is primarily fed by snowfall at high elevations that drains through the mine and out the mine portal. A large settling basin will be constructed using the Terrible decline and at this location, a centralized water pumping plant will be constructed to supply water needs for the mine. The centralized pumping system will deliver water to all smaller retaining areas via 4- or 6-inch HDPE pipe. The smaller sumps will be located near current production areas and will activate the pumping plant via automatic level controls. The mine water use is expected to average < 100 gpm during production.

Fresh water is required for makeup to the process water, seal water for pumps, and for reagent preparation and is delivered to the mill facilities by gravity flow from the main tunnel and into the bulkhead tank located at the head of the rail car tipping tunnel. Fresh water is piped by gravity from this tank to the freshwater pumps located in the crushing area. The mill makeup water is supplied from the mine sump through existing 4-inch lines from the mine sump. The mill requires up to 40 gpm of makeup water. Dust suppression on the surface requires less than 10 gpm average during the summer.

The groundwater is available for use at a rate between 300 gpm and 1,000 gpm depending on the time of year. Typical historical average annual availability is approximately 350 gpm. The water quantities increase during the periods where snow is melting and is lowest in the middle of the winter when ground water freezes at the surface in this mountainous area.

Sneffels Creek flows through the mine property and OSMI has water rights to allow water use if required. This is a backup to the current groundwater supply.

Mine Water

Groundwater encountered during mining operations is pumped using air and electric pumps to the Revenue drift level and into the service water sump. Water not needed for mine or mill operation is delivered into a discharge ditch that runs along the main haulage drift and exits the underground at the portal where the water is routed through a ditch to the surface water control facilities and the operating passive water treatment system for groundwater infiltration.

Ground water enters the existing #1 shaft at various locations along its excavation. Water levels in the shaft have remained static over the last 20 years at approximately 280 ft below the collar of the shaft due to the influence of the Campbird 14 level tunnel approximately 5,000 ft away and 900 ft below the collar elevation. OSMI has designed a pumping and discharge system that will move the water up the shaft and into the revenue tunnel ditch using multiple phase vertical turbine pumps capable of handling up to 1,000 gpm. During the Ranchers era once dewatering was complete, an average of less than 200 gpm was pumped continuously from the shaft.

Potable Water

Potable water is supplied to surface structures by capturing groundwater underground, the Portal Spring. Water is collected at coffer located in each location and piped out, via the Revenue Tunnel to a storage tank at the mill and to storage cisterns located near the administration building. Upon demand from each system, water is mechanically pumped to one of two identical treatment plants where filtration, chemical disinfection and storage occurs. Both water treatment facilities are permitted with CDPHE under Potable Water Supply ID CO-0246283 . All potable water is monitored under the recommended schedule established by CDPHE.

Water Treatment

A five stage passive mine water treatment system incorporating a settling pond, a sulfate reducing bio-reactor, an aeration channel, and polishing pond is constructed on site and treats water from the mine prior to discharge via a permitted outfall. Figure 18-9 shows a cross-section schematic of the passive water treatment system.

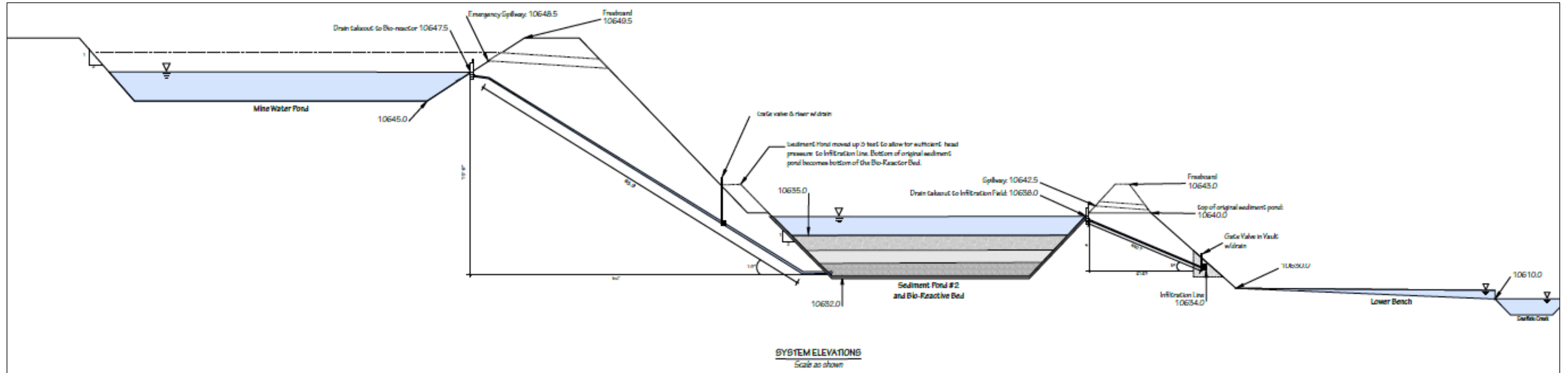

Source: OSMI, 2016

Figure 18-9: Passive Water Treatment System Cross-Section (Schematic)

18.2.7 Compressed Air Systems

There are two compressed air systems on site. One system provides air to the processing plant and the other supplies the mine.

The mine compressed air system operates slushers, air chutes, EIMCO-style overshot muckers, CAVO type overshot muckers, jackleg drills, air pumps, and miscellaneous small tools.

The mine compressor system supplies the mine with approximately 125 psig compressed air through the newly installed 7,800 ft. of 10- and 8-inch HDPE main air line that are located in the main revenue drift from the surface compressor to the working areas. This line replaced the existing air lines that were at the end of their life and has improved the overall air quality, quantity and pressure of air available for mine operations. The main air line provides air to feeder lines that are 6-inch HDPE lines that distribute air to upper and lower levels of the mine through raises. The 6-inch lines feed 4-inch air supply lines that further distribute air to the development and stope production faces.

18.2.8 Power Supply System

Power is supplied to the site through an existing three phase 12.47 kilovolt (kV) overhead powerline owned and operated by San Miguel Power Association. The line has a capacity of 3 MW. The site increased the backup generation capacity to 3 MW by replacing the existing generator with a larger generator. The rate for overhead powerline electricity to the mine site charged by San Miguel Power Association is US\$0.070926/kilowatt hour (kWh), with an additional demand charge of US\$17/kw. This equates to an approximate total cost of US\$0.12/kWh.

Installed Load and Maximum Demand

Table 18-10 summarizes the total, maximum demand and average site power requirements including underground, process plant and ancillary infrastructure.

Table 18-10: Site Connected Power Requirements

Description	Installed Load (kW)	Maximum Demand (kW)	Average (kW)
Project Total	4,623	3,110	2,819

Source: OSMI 2017

Plant/Project total installed load includes standby equipment and existing loads, which will remain in service and does not include any future loads.

Total maximum demand load is based on the available mechanical equipment list, single line diagrams, and information provided by OSMI site personnel.

The plant maximum demand load assumes a load factor of 66% for the majority of the loads and takes into account standby loads to account for an 73% demand factor and an 82% altitude de-rating factor for upsized equipment.

Plant annual average operating load assumes a utilization factor of 0.92 for the majority of the plant process equipment.

Equipment startup is staggered and sequenced to allow for inrush requirements on the power system.

Electrical Distribution

The plant incoming line, 12.47 kV, is stepped down to 4.16 kV through three existing 15 kV sectionalizing cabinets connecting to the new 5 MVA transformer. The 5 MVA transformer and 4,160 V switch gear feed all existing, modified and new loads.

Existing switchgear and MCCs are located inside the existing electrical buildings.

The underground power is distributed at 4160 kV and will then be stepped down to 200 V or 480 V as needed at the stopes and for power to the underground equipment including fans, pumps, locomotive battery charger, slushers, hoists, and miscellaneous lighting.

Transformers and Compounds

The plant main existing transformers, 12.47 / 4.16 kV (main incoming) and 0.48 / 4.16 kV (diesel generator) are de-rated for the site altitude, and both are grounded by neutral grounding resistors.

4.16 kV / 480 V distribution transformers are solidly grounded and installed at different locations on the site.

4.16 kV Switch Gear

The existing main 4.16 kV switchgear provides feeder to MV fused switchgear and distribution transformers.

Existing MV fused switchgear provides power to the crusher area and mill area transformers.

480V Switch Gear

The existing 480 V switchgear provides feeders to mill area MCCs. There is a 600 A breaker available in this switchgear that will be used to feed the new 480 V MCC, which is required for new and modified mill area loads.

Low Voltage Variable Frequency Drives

Low voltage (LV) VFD units with line reactors will be utilized. They are floor or wall mounted (dependent upon size) along the internal wall of the electrical rooms.

480 V Motor Control Centre (MCC)

Existing 480V MCCs were re-arranged according to the new design and process needs. New or modified loads in mill area that could not use available spares on existing MCCs were connected to the new 480 V MCC, installed in the existing electrical building and fed from the existing LV switchgear. Starters and incoming circuit breakers in this MCC are of withdraw-able design complete with protection. All motor starters will be equipped with intelligent protection relays with Ethernet / Internet Protocol (IP) communication. The LV MCC supplies power to the low voltage motors, low voltage variable speed drives and low voltage distribution boards.

The existing MCCs in crushing area and filter building were modified to add new sections to feed new and modified loads in those areas.

A new MCC and transformer were installed to provide power to the new air compressors and additional loads in the new reagent area.

Grounding System and Lightning Protection

The following method of system grounding is and will be implemented at various voltage levels:

- 4.16 kV: Low resistance grounding; and
- 480 V: Solidly grounded.

Existing grounding and lightning protection were extended to provide required protection and coverage for all exposed points of the new equipment and structures. Extended lightning protection system has its own independent grounding electrodes and will be interconnected with the power grounding system.

Emergency Power

Emergency power is provided on the site by means of the new 3 MW diesel generator. This new generator is installed just to the west of the mill building locating it in proximity of the main transformer. The 3 MW connected to the system via the existing 3 MVA step up transformer. The backup generator will be diesel and fuel will be supplied from an existing 10,000-gallon tank on site. All process and mine loads will be on emergency power. Emergency power is generated at 4,160 voltage alternating current (VAC) and is connected to the main 4.16 kV switchgear. Transfer from normal power to emergency power is automatic with the loss of normal power at the 4.16 kV switch gear.

18.2.9 Propane Supply

Propane is supplied to the site by JC Propane and used for site heating, primarily the portal and to keep the track and drift from icing up, during the winter months. There are six propane tanks located on site. The propane tanks are protected by small buildings. The tanks are located at the portal for intake air heating, at the filter building for heating and at the administrative building for heating. The tanks are each 1,000 gallons in capacity and filled by truck on an as needed basis during the winter months.

18.2.10 Fuel and Lubricant Storage

The site has a diesel and lubricant storage facility that includes 10,000 gallons of diesel storage at the mine site and 500 gallons each of diesel and gasoline storage at the warehouse. The diesel storage tank on site is a double-walled tank, located in a controlled area with all applicable environmental controls in place as required per permit. The tanks are filled by a local contracted vendor on an as needed basis. The system is in place and meets the Project requirements.

18.2.11 Surface Crusher Plant

The surface crusher and screening plant were to be modified during the preproduction period. The modifications include demobilization of the existing plant and reconstructing the plant at the current crushing facility. The new plant is to be capable of producing up to 75 st/h and consist of a single jaw crusher, vibrating screen, and a three-foot short head cone crusher. The plant is constructed utilizing some of the equipment from the underground crushing facility that is being removed as part of the redesign.

18.2.12 Mine Administration and Dry Building

The Project has an existing two-story mine administrative and dry building that has six offices, showers and change facilities. The mine site infrastructure was built in 2013 and has permanent facilities in place. On-site facilities include a change house (dry) with showers and bathrooms for women and men and locker space for 66 employees before expansion. The facility contains nine offices of which three of which can accommodate between two to four people each. In addition, change facilities, office space and a conference room exist in the mill building which ample capacity for all mill and construction

employees. The existing two-story structure is 2,350 ft² on the main floor. The main floor houses the dry facilities, and the upper floor contains the management, technical and safety offices. The current square footage of the administration building on site is insufficient to facilitate the number of miners and technical staff that will be required for updated mining operation.

A remodeling of the administration building took place during the previous pre-production period. The building was extended 30 ft to the southwest adding an additional 1,410 ft² of usable space on each floor. The expanded dry has locker facilities for 100 personnel. The expansion will increase this number to approximately 100. Figure 18-11 shows the remodel.

18.2.13 Railyard Building

A new rail switchyard building was constructed over the mine portal entrance. This building is intended to protect the switchyard and waste dump area from the winter snow and summer rains. It also provides a maintenance area and open bulk material storage prior to shipment underground (Figure 18-12).

18.2.14 Mill Reagent and Compressor Storage Building

A new building to store mill reagents and house mill compressors was also constructed during restart. Equipment and piping will be completed in 2022. The general arrangement for this facility is shown in Figure 18-13.

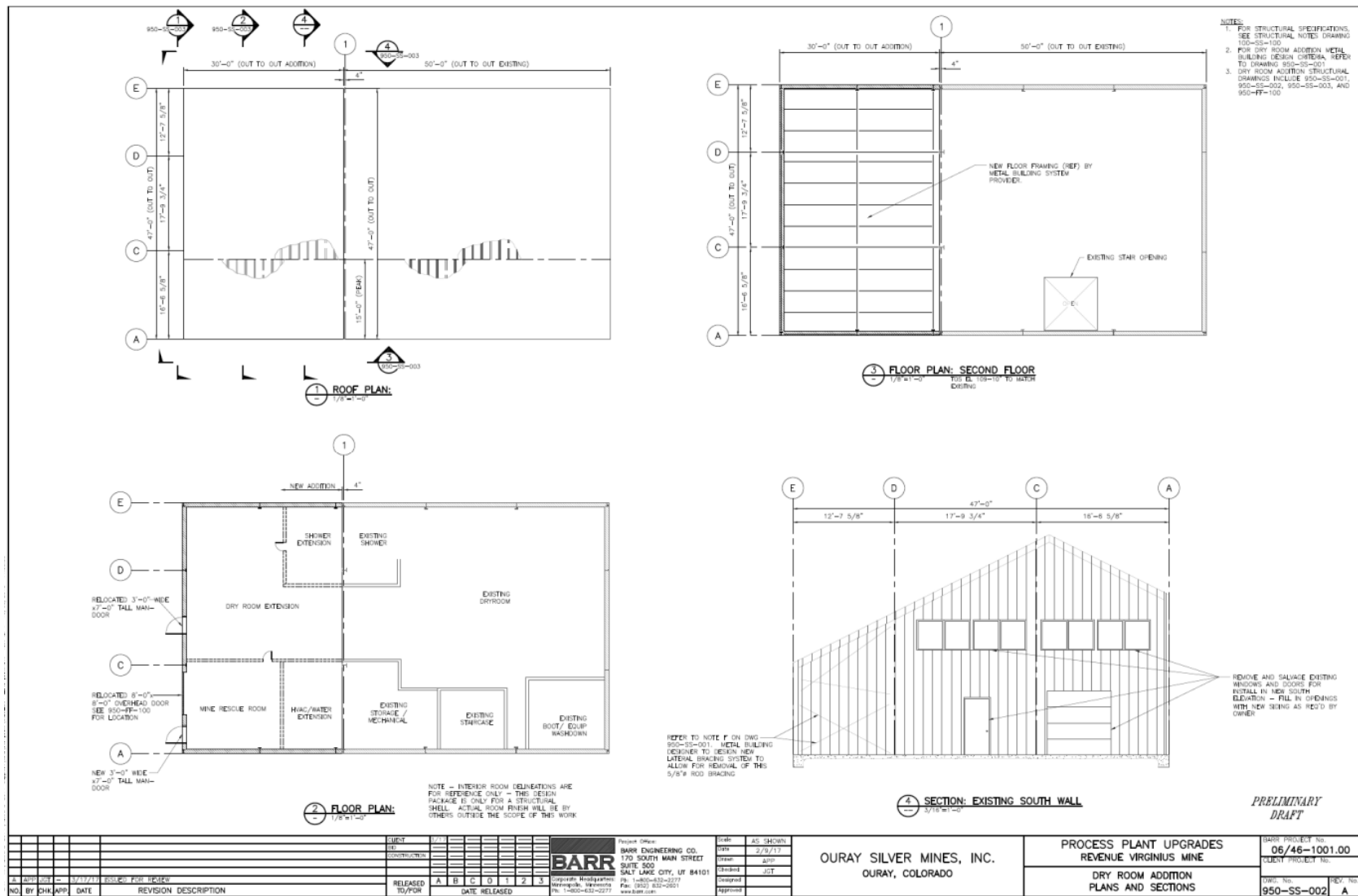

Source: OSMI/Barr, 2017

Figure 18-11: Upper-Level Plan View of New Change house Area

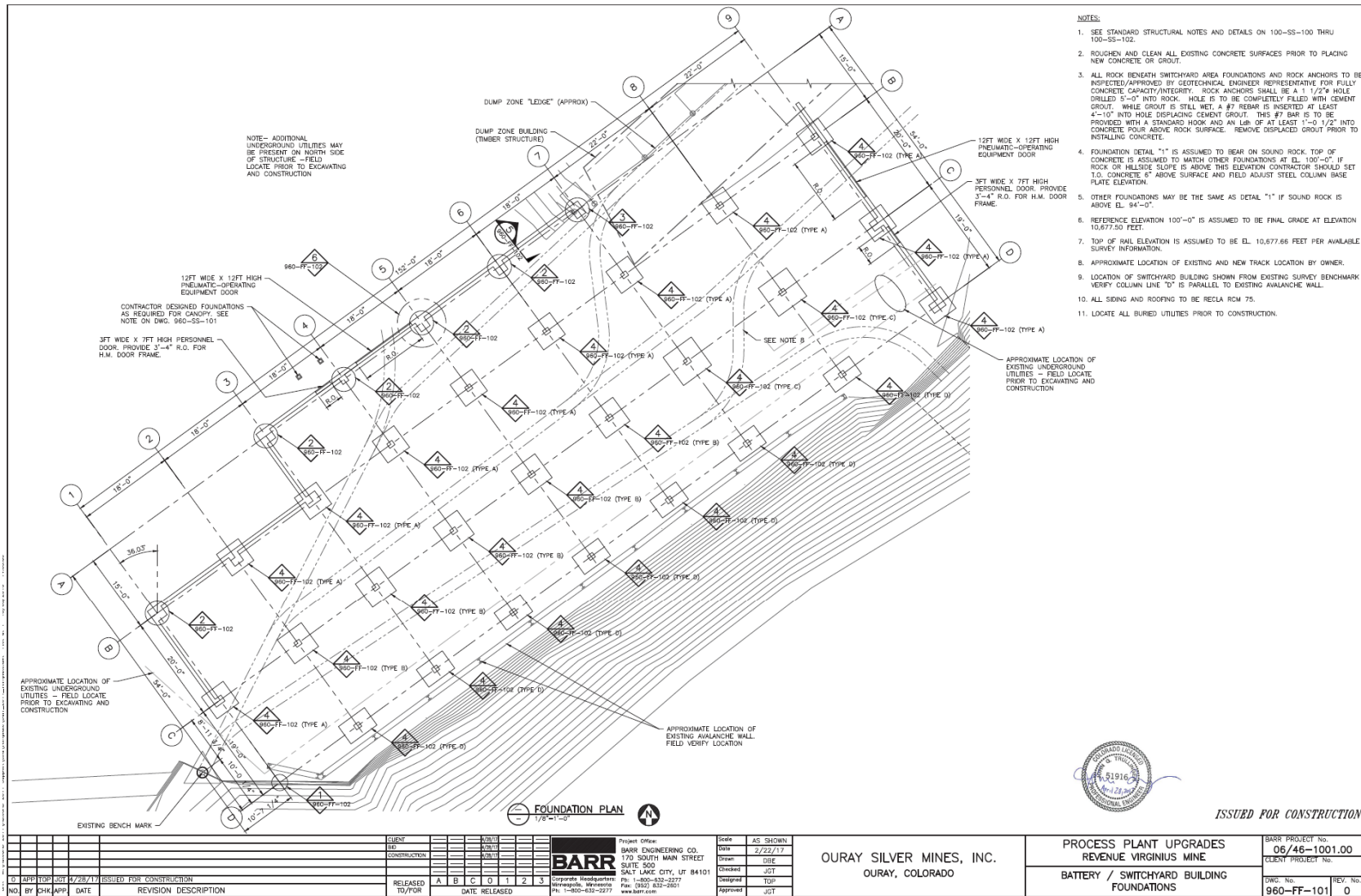

Source: OSMI/Barr, 2017

Figure 18-12: Ground Level Plan View of New Switchyard Building

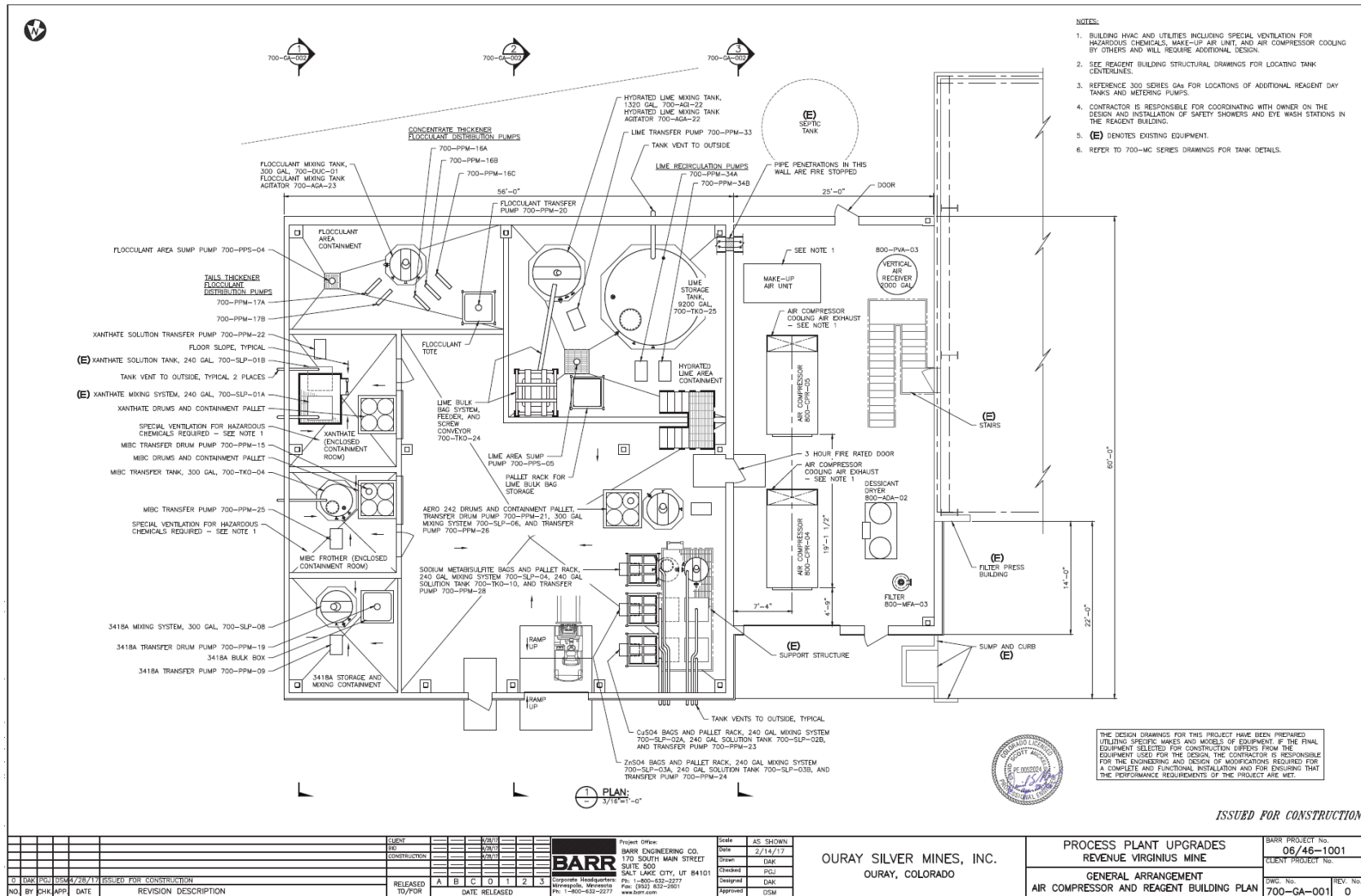

Source: OSMI/Barr, 2017

Figure 18-13: General Arrangement of Compressor/Reagent Building

18.2.15 Explosives Storage

The site receives explosives deliveries by truck and the explosives are stored in two powder and two primer magazines located underground in the Yellow Rose Drift and in the second diamond drilling station on the Monongahela. The second powder magazine has been constructed during pre-production in one of the drill station crosscuts along the Virginius North drift. Logistics issues were resolved effectively during the previous pre-production periods and the deliveries are consistent and on time.

18.2.16 Laboratory

A laboratory facility will be installed at the warehouse site in Ouray. Contract laboratory services will be provided by an independent third party to provide assay and chemical analyses to support the mill and mine operations. Capital and operating costs supplied in the proposal are used in this report. The total estimate for laboratory initial capital cost is US\$300,000.

18.2.17 Weigh-Scale

Concentrate loadout scales are currently installed at the Project and will continue to be used.

18.2.18 Security/ Gatehouse

The site has installed security cameras in various locations and a gated entryway directly linked to motion control image capturing software. Operations are 24 hours per day and the cameras are setup to be also continuously monitored from the mill control room.

18.2.19 Communications

The site and warehouse have telephone and internet service through a local internet/phone provider as noted above. Additionally, there is a two-way surface radio and pager system that can communicate both underground and on surface with both the site and warehouse.

The Project capital costs includes the installation of a satellite communication system and complete upgrade of onsite communications. The new system has duplicated servers both at the warehouse and site which are linked through the satellite feed. Network and Voice over Internet Protocol (VoIP) communication are be routed either through the CenturyLink, Inc. (CenturyLink) fiber optic line or through satellite in the event of an interruption of service.

18.3 Tailings Management Area

The Project has two permitted TSFs. A Tailings and Waste Management Plan of operations was submitted to DRMS and has been approved for use by the agency. This work was conducted by Greg Lewicki and Associates (Lewicki, 2015) and includes descriptions of the planned filtered tailings as received from the mill, compaction tests results and field compaction requirements, cold weather management plan, and ultimate planned pile configurations. Geotechnical laboratory testing was conducted by CTL Thompson (Thompson, 2015) and their report included slope stability estimates.

SRK has reviewed the Lewicki and CTL Thompson documents. This work has been conducted according to industry standards and provides a reasonable starting point for assessing the tailings storage needs for this design. SRK has relied on these documents to update the design for the current FS production requirements.

SRK has conducted laboratory testing on filtered tailings. Compaction and direct shear test were conducted by IGES in Salt Lake City (IGES, 2017). These tests were conducted according to the following standards:

- Modified Proctor Compaction tests: ASTM D1557 A
- Direct Shear Test for Soils Under Drained Conditions: ASTM D3080

The results of the tailings testing are summarized on Table 18-1. Sample #3, highlighted in blue, was used for input strengths for the slope stability analysis of the dry stack pile.

Table 18-1: Summary of Filtered Tailings Laboratory Direct Shear Test Results

Test	Fri (deg)	Cohesion (psf)	Water Content (%)	Dry Density (lbs/ft ³)
Sample #1	28	390	13	120
Sample #2	38	66	16	118
Sample #3	35	223	14	118
Sample #4	35.8	335	17	113

Source: SRK

The plant was not operating during the recent site visit, so it was not possible to observe whether the plant is producing tailings at these water contents. However, staff confirmed that tailings moisture contents were comparable when the plant was operating.

SRK designed an expanded TSF within the same permitted footprint to meet the required volumetrics and design to hold the tailings generated in the FS LoM plan and provided a geotechnical stability analysis confirming the design. According to the production schedule, the TSF dry stack pile will provide storage for 574,965 st of filtered tailings and 222,469 st of waste rock, for a total of 797,434 st of combined waste and tailings.

The design has assumed the following conditions:

- The in-situ density of waste rock is 170.9 lbs/ft³
- The in-situ density of mineralized ore from dike is 181.9 lbs/ft³
- The bulking ratio for compacted waste rock is 1.55
- Both waste rock and filtered tailings will be compacted in place to at least 90% of modified Proctor density by controlling moisture content and compactive effort
- The compacted density of filtered tailings is 118.0 lbs/ft³ compacted at 13% moisture content (90% modified Proctor density)
- The in-situ moisture content of filtered tailings will be an average of 15% during operations (after compaction)
- The boundaries of the TSF dry stack pile are as shown in red on Figure 18-14
- The critical cross sections for stability are in the north-northeast direction as shown on Figure 18-14
- Tailings placed on the Revenue pile (eastern pile) during the summer months from May through November
- Tailings placed on the Atlas pile (western pile) during the winter months from December through April due to avalanche precautions

On the recent site visit, it was not possible to observe the tailings in the as-placed condition due to the piles were covered in snow. However, staff confirmed that tailings placement is following the above requirements.

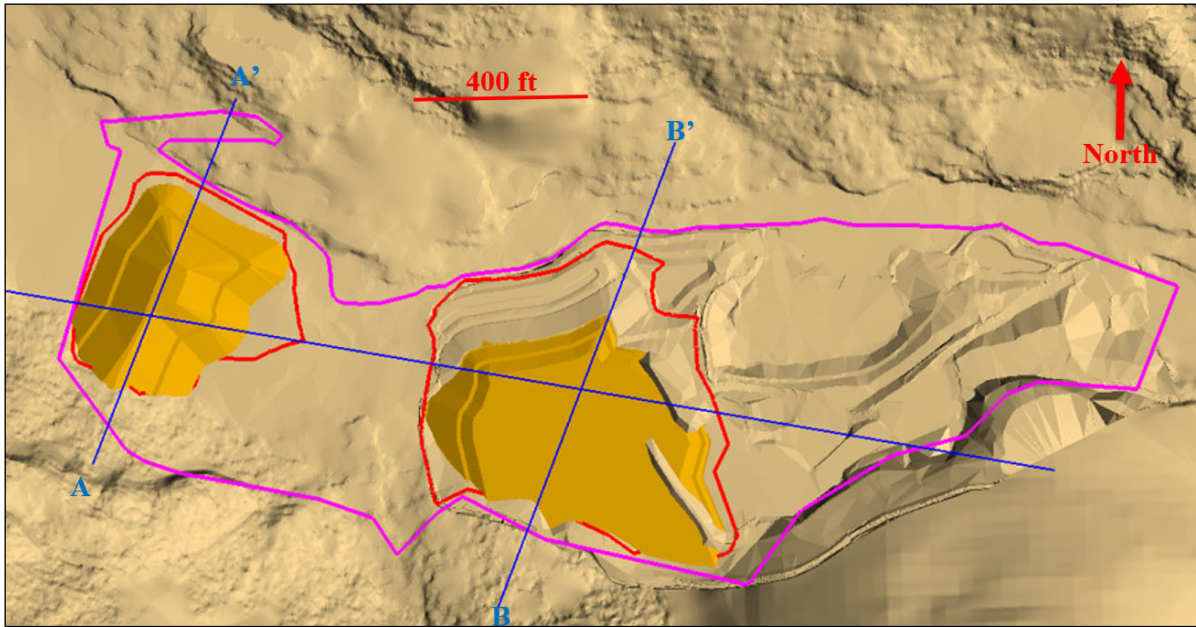

Source: SRK

Figure 18-14: Plan View of TSF Dry Stack Pile with Limits of Pile Shown in Red

Given these assumptions, SRK has estimated that the storage volume required is the following:

- Winter storage required on Atlas: 5.893 Mft³
- Summer storage required on Revenue pile: 9.129 Mft³
- Total storage capacity required: 15.022 Mft³

The required storage capacity curve is shown on Figure 18-15.

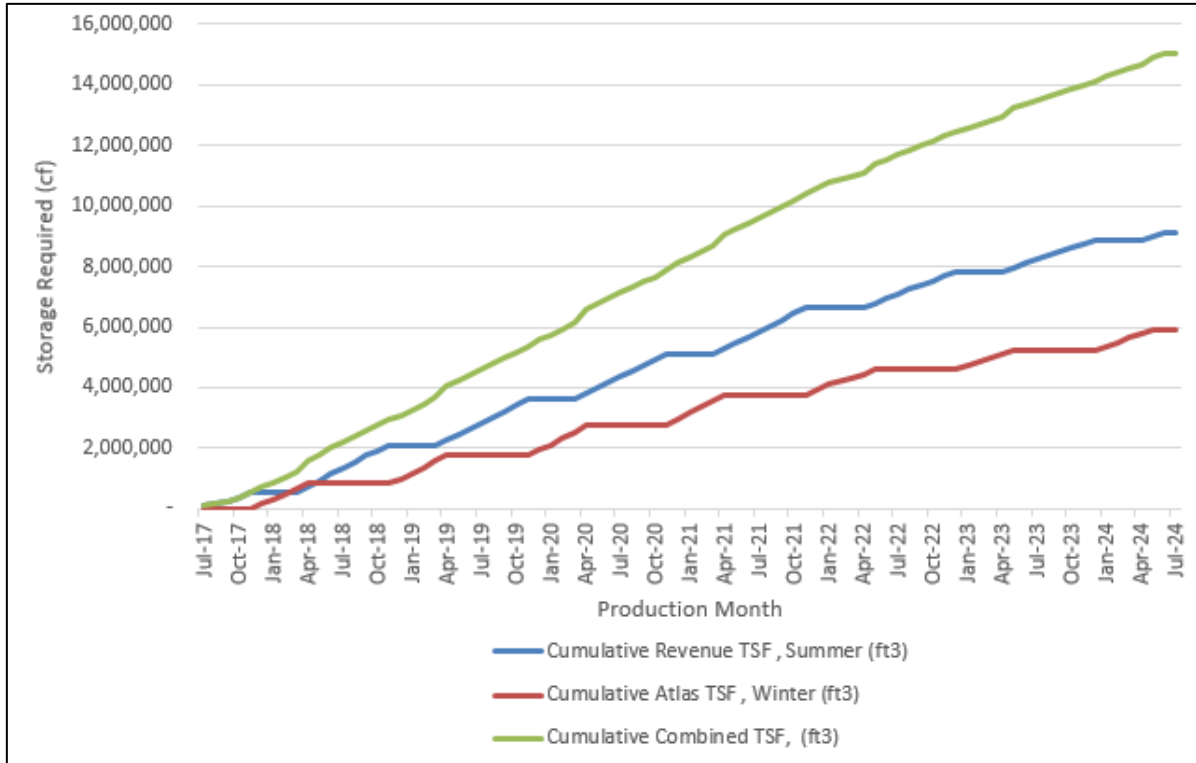

Source: SRK, 2017

Figure 18-15: Required Tailings Storage Capacity Curve

A permit revision in the future will be required to modify the permitted 8.9 Mft³ storage capacity which will be exceeded after about 5 years of continuous production. Since the revision is in the same footprint as the current TSF, it does not impact the current permit boundary or disturbed area and therefore will be a Technical Revision which does not require public notice. SRK currently sees no reason such Technical Revision would not be granted. Figure 18-16 shows the piles for this period. Note that the avalanche berm is still functional, and the Revenue pile height is not yet sufficient to deflect any potential avalanches. The final comingled waste piles are shown on Figure 18-17. The total storage capacity of each pile is as follows:

- Winter storage available on Atlas: 4.049 Mft³
- Summer storage available on Revenue pile: 11.159 Mft³
- Total storage capacity available: 15.208 Mft³

The total capacity available is greater than the quantity required by about 0.186 Mft³. As the Revenue pile raises above the south slope of the avalanche run, some of the tailings produced during the winter can be stored on the Revenue pile.

SRK has conducted a stability analysis using SLIDE program (Rocscience, 2016) for the Spenser solution method with includes a balance of forces and moments. The assumed input parameters are from Table 18-2, Sample #3 (blue highlighted). A summary of the predicted FOS under both wet and dry conditions are provided in Table 18-2. The output FOS Atlas north-northeast cross Section A is shown of Figure 18-18. The water table is shown on this figure. All cases analyzed have a FOS greater than the minimum 1.3 criteria.

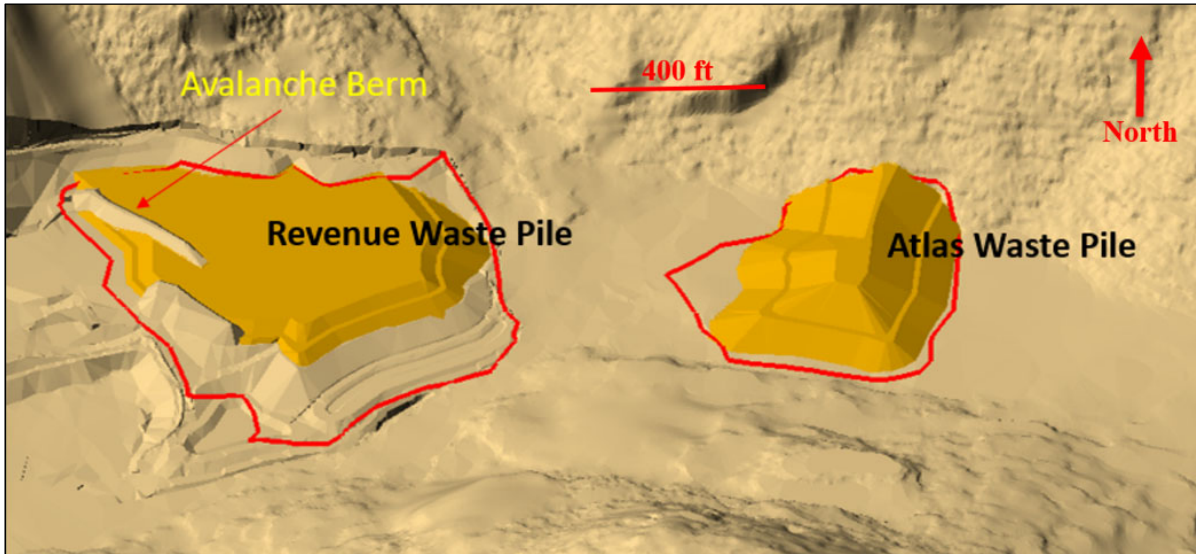

Source: SRK

Figure 18-16: Perspective View of the TSF Piles Looking Towards Southwest After 5 Years of Production

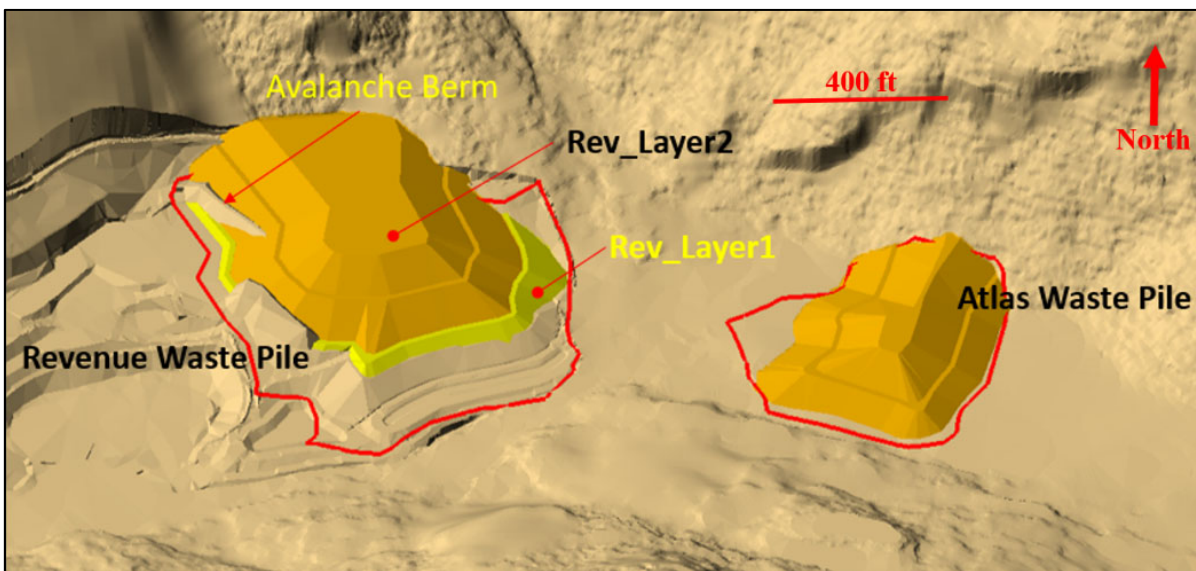

Source: SRK

Figure 18-17: Perspective View of the TSF Piles Looking Towards Southwest After Life-of-Mine

Table 18-2: Summary of FOS Stability Analysis

Section	FOS, Dry Conditions	FOS, Wet Conditions
Section A – Atlas N-NE	2.86	2.17
Section B – Atlas W-NW	2.83	2.4
Section C – Revenue N-NE	2.55	2.08

Source: SRK

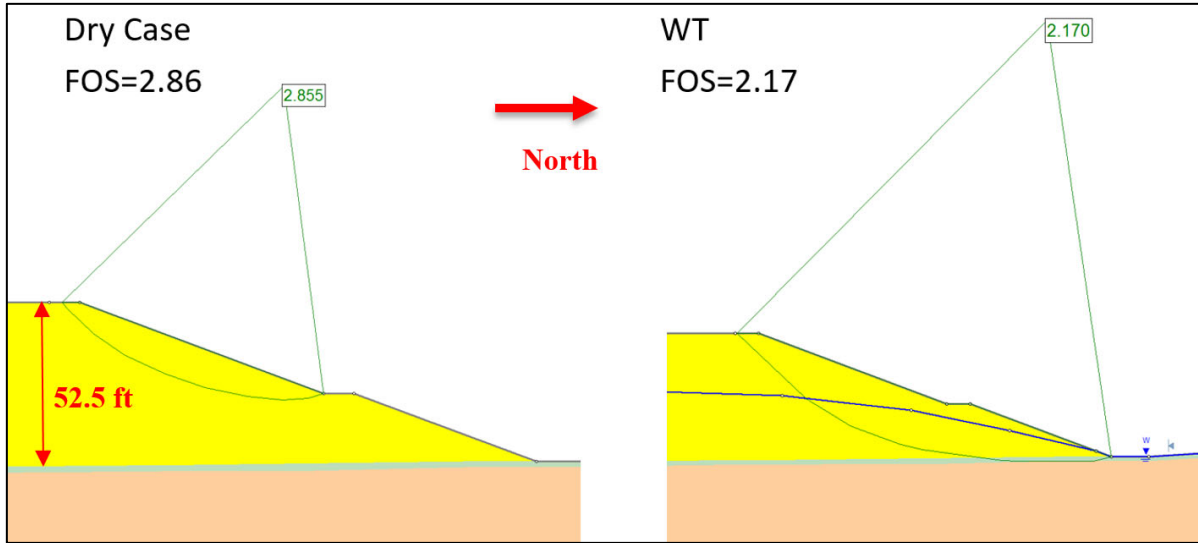

Figure 18-16 shows location of A-A" cross section
Source: SRK

Figure 18-18: Example Slope Stability Output for Atlas North-Northeast Cross Section A

In summary, SRK has designed the filtered tailings piles within the existing permit boundaries to a height that can store the required storage capacity. The tailings have been tested for shear strengths and those values have been used in stability analyses to demonstrate that the FOS is greater than the minimum 1.3 criteria. The availability of the two separate piles provides the operational flexibility to store tailings as conditions demand.

19 Market Studies and Contracts

The Project will target sales of silver, gold, zinc and lead. These metals will be sold in concentrate form with a lead concentrate hosting the saleable lead, silver and gold and a zinc concentrate hosting the saleable zinc.

19.1.1 Feasibility Study Metal Price Assumptions

The primary commodities produced by the Project, silver, gold, zinc and lead, are sold into large and liquid markets with transparent pricing (e.g., London Metal Exchange for base metals and COMEX for gold and silver). Therefore, for the purpose of this study, it is assumed that the pricing mechanism for each commodity will be based on either spot market prices at the time or contract prices that are reflective of spot prices, at the time the contracts are entered into.

For the purposes of selecting the most appropriate pricing to use in this analysis, OSMI provided analyst median 2023 commodity price forecasts compiled by Bloomberg as of 12/23/21. They additionally provided analyst median 2023 commodity price forecasts dated 1/20/22 compiled by BMO. Further, SRK has an internal subscription to a similar group that provides commodity price forecasts based on expert opinion (the Energy and Metals Consensus Forecast, published by Consensus Economics Inc.). Utilizing the Consensus Economics data, SRK provides internal guidance for reasonable long-term pricing to use for reserve estimation purposes (note that this information is only provided for context for SRK’s QPs and its use is not mandated by SRK).

Table 19-1 presents a comparison of the forecasts provided by OSMI and SRK’s internal guidance (dated December 13, 2021), as well as current (March 1, 2022) spot prices for each commodity. As can be seen, the SRK guidance is generally lower than the Bloomberg and BMO forecasts. SRK’s approach to selecting prices for the purposes of this feasibility study was to utilize the Bloomberg price forecast with adjustments where appropriate. There has been considerable escalation in the time since the 2018 FS and the current market pricing. SRK chose prices between the BMO and Bloomberg pricing to be conservative recognizing the current spot price and the relatively short life of this project. The prices utilized for this feasibility study are also presented in Table 19-1. For context, the differential between the metal price utilized in the feasibility study and the spot price is also presented in the table. In SRK’s opinion, these prices are reasonable in the context of the forecast data and spot pricing.

Table 19-1: Metal Price Forecast Comparisons (US\$)

Metal	2018 FS Price	2022 FS Price	12/23/2021 Bloomberg 2023 Commodity Price Forecast	12/13/2021 SRK Internal Long-Term Price	1/20/2022 BMO 2023 Commodity Price Forecast	3/1/2022 Spot Price	FS to Spot Differential
Silver	18.50/oz	23.84/oz	23.84/oz	19.25/oz	23.75/oz	24.64/oz	-3%
Gold	1,300/oz	1,720/oz	1,693/oz	1,400/oz	1,765/oz	1,904/oz	-10%
Zinc	1.20/lb	1.34/lb	1.42/lb	1.00/lb	1.15/lb	1.71/lb	-22%
Lead	1.00/lb	0.98/lb	1.02	0.84/lb	0.95/lb	1.09/lb	-10%

Source: SRK 2022

19.1.2 Concentrate Market Study

The Project will sell the metals it produces in concentrate form and revenue will be based on terms provided by traders or smelters to which the concentrate is sold. As the terms of purchase from both

smelters and traders can be variable with most data not made public, a study was commissioned by OSMI to evaluate likely purchase terms that may be received by the Project. The study was completed by Bluequest Resources AG (Bluequest).

Bluequest is a specialist advisor on commercial and logistical matters for base metals and concentrates. Based on the analysis performed by Bluequest, the lead and zinc concentrates will both be readily salable in the open market to both traders and smelters. The lead concentrate is expected to incur penalties for both arsenic and antimony levels but given the high content of silver will nonetheless be an attractive concentrate. The zinc concentrate is not anticipated to have any elements above penalty level and is also expected to be desirable. Concentrate specifications are provided in Table 19-2 and expected concentrate sales terms are provided in Table 19-3 and Table 19-4. Notably, although Bluequest suggests that precious metals in the zinc concentrate will likely be payable, for the purposes of economic modelling, SRK has conservatively assumed that OSMI will not receive any value for the contained precious metals in the zinc concentrate.

Table 19-2: Expected Concentrate Specifications

Element	Units	Pb Conc. 400 mt/m	Zn Conc. 100 mt/m
FA Ag	ppm	8,000 to 13,000	200 to 600
Au	g/mt	10-20	<3.11
Al	%	<0.15	<.10
Ba	%	< 0.02	< 0.02
Bi	%	<0.001	<0.001
Ca	%	<0.1	<0.10
Cu	%	0-5%	0.10 -0.30
Fe	%	0-3.5%	3-5
K	%	<0.1	<0.20
Mg	%	<0.05	<0.05
Mn	%	<0.5	<.030
Mo	%	< 0.002	< 0.002
Na	%	<0.1	<0.10
Ni	%	<0.003	<0.003
P	%	<0.03	<0.03
Pb	%	62-72	<2.50
S	%	12-18	30-35
Si	%	<6	<6
Sn	%	< 0.005	< 0.005
Ti	%	<0.0065	<0.0065
W	%	<0.024	<0.40
Zn	%	2-7	52 - 60
Zr	%	<0.003	<0.003
As	ppm	<2500	<7000
Cd	ppm	<500	<3000
Co	ppm	<50	<50
Cr	ppm	<5	<3.0
Li	ppm	<250	<350
Re	ppm	<100	<100
Sb	%	0-2.5	<400
Te	ppm	<10	<10
Tl	ppm	<10	<10
V	ppm	<25.0	<25
Hg	ppm	<10	<50
Se	ppm	<10	<25
Cl	ppm	<50	<50
F	ppm	<20	<20

Source: Bluequest 2017, modified by SRK 2021

Table 19-3: Forecast Lead Concentrate Sales Terms

Metallic Payables for Each Dry Metric Tonne		
Metal	Payables	Subject to a Minimum Deduction
Gold	95%	1 g/mt
Silver	95%	50 g/mt
Lead	95%	3 units
Copper	>2.5% Cu; 100%	Lead price
Zinc	Not payable	
TC, RC, Key Penalties, Costs for Freight, WSMD and Assaying		
Conc. TC	US\$75-200 per mt; US\$150 would be a conservative long-term market for this material. – benchmarked minus \$40/dmt Yr1, Benchmarked minus \$20/dmt after	
Gold RC	US\$8-10/oz	
Silver RC	US\$0.70-1.40/oz (Benchmark minus 10% to max. of \$0.10/troy oz.)	
Price Participation/Scale	None	
As Penalty	US\$0 to US\$1.5 per each 0.1% of As above 0.3% per mt	
Sb Penalty	US\$0 to US\$1.5 per each 0.1% of Sb above 0.3% per mt	
Freight	US\$150 to US\$200 per wmt	
WSMD + Assaying	US\$5 to US\$30 per mt	

Source: Bluequest 2017

Table 19-4: Forecast Zinc Concentrate Sales Terms

Metallic Payables for Each Dry Metric Tonne		
Metal	Payables	Subject to a Minimum Deduction
Gold	75% after a deduction of 1.5 g	8 units
Silver	75% after a deduction of 93.3105 g	
Lead	Not payable	
Zinc	85%	
TC, RC, Key Penalties, Costs for Freight, WSMD and Assaying		
Conc. TC	US\$100-200 per mt; US\$175 would be a conservative long-term market for this material.	
Gold RC	not applicable	
Silver RC	not applicable	
Scales	None	
As Penalty	US\$1.50 for each 0.1% of As above 0.3% per mt	
Sb Penalty	US\$1.50 for each 0.1% of Sb above 0.3% per mt	
Freight	US\$150-200 per wmt	
WSMD + Assaying	US\$5-30 per mt	

Source: Bluequest 2017

19.2 Contracts and Status

OSMI is has an agreement for sales of each of lead and zinc concentrate. The lead contract is for 22,000 dry metric tons of lead concentrate to be delivered within 60 months of from the start of production. The zinc contract is for a minimum of 5,400 dry metric tonnes of zinc concentrate at a rate of 1,080 dry metric tonnes per calendar year to 60 months after production start.

SRK’s review of the agreements confirmed agreement with the marketing information and costs terms indicated in Section 19.1.2.

20 Environmental Studies, Permitting and Social or Community Impact

Mining and mined land reclamation in the state of Colorado are declared necessary, proper, and compatible activities under the Colorado Mined Land Reclamation Act, Mineral Resources, Title 34 Article 32 of the Colorado Revised Statutes (CRS). The reclamation approvals and permitting for mine-related activities fall under the jurisdiction of the Mined Land Reclamation Board (the Board). The Division of Reclamation, Mining and Safety (DRMS) administers the existing Section 112d Designated Mining Operation (DMO) and Reclamation permit No. M-2012-032 for the Project.

As an existing permitted facility, OSMI has the permits required to operate the mine and mill. This section of the FS provides a summary of significant environmental aspects and ancillary operating permits for the Project.

20.1 Required Permits and Status

The Project operates in accordance with the DRMS Section 112(d) Permit Number M-2012-032. In addition to the DRMS permit requirements, the Water Quality Control Division (WQCD) of the Colorado Department of Public Health and Environment (CDPHE) regulates surface water quality under the authority of the Colorado Water Quality Control Act (Title 25 Article 8 CRS). The Air Quality Control Division (APCD) of the CDPHE regulates air quality under the Colorado Air Pollution Prevention and Control Act (Title 25 Article 7 CRS). The Hazardous Materials and Waste Management Division (HMWMD) of the CDPHE regulates solid waste management and disposal including hazardous waste. The Project operates under additional federal, state and local permits as noted in Table 20-1.

The following section provides a description of permitting actions that have occurred since Amendment 01 was approved in 2015.

20.1.1 DRMS Program

Table 20-1: Existing Environmental and Operational Permits

Agency	Permit	Original Permit Date	Purpose	Key Modification(s)/ Date	Expiration Date	Reporting Requirements	Monitoring Requirements	Status	Comments	
DRMS	M-2012-032	2/5/2012	112d Mining Permit, regulates surface disturbance, mining, reclamation, and groundwater	Amendment 1 20Aug2015		Quarterly and Annual	Quarterly	operational	Modified to update facilities and allow for ore processing for Governor Basin (rescinded). Includes TR-01, TR-02, TR-03, TR-04, TR-05, and TR-06	
				TR-08 5July2016		N/A	N/A	complete	Allows for infiltration of mine water discharge to groundwater following passive treatment, thus limiting discharge to surface water.	
				TR-09 March 2017		N/A	N/A	complete	Updated groundwater standards, allowed sale of mixed tailings and waste rock as road base, relocation of buildings, construction of additional sheds, attempt to permit mill discharge rejected based on lack of treatment system detailed engineering	
				TR-10 31Aug2018		N/A	N/A	Complete	Construct 5-stage passive mine water treatment system with new surface water discharge outfall at 002A. Construct new GW monitoring well GW-04 and relocate diesel tank.	
					TR-11 October 2020		N/A	N/A	Complete	Update water monitoring program, allow placement of passive mine water treatment substrate from pilot study within affected lands boundary, incorporate a waste storage facility and enclosure in the list of structures, update reclamation plan and reclamation map to address minor modifications to topsoil placement and new structures.
					TR-12 September 2021		N/A	N/A	Complete	TR-12 was submitted in March of 2021 and requested approval for the replacement of the groundwater monitoring well GW-04 with a new well GW-04R. This replacement is in response to the discovery of historic organic residue in the well and a DRMS request for Corrective Action and Revisions in February 2021. During adequacy review, OSMI no longer proposed a replacement well GW-04R and committed to monthly visual monitoring for leaks along the out-slope of Mine Water Pond #3.
					TR-13 (rescinded)	N/A	N/A	N/A	N/A	Incorporated into Amendment 2
					TR-14 April 2021	N/A	N/A	N/A	Pending	TR-14 was submitted in April 2021. This revision provided updates to the Environmental Protection Facility (EPF) certification plan for the new Reagent Room portion of the mill filter building extension (permitted under TR-09). These updates include the reasoning, characteristics, construction, operation, and reclamation measures associated with the Reagent Room EPF.
					TR-15 June 2021	N/A	N/A	N/A	Pending	This revision sought recertification of the mill. Certification approval of the mill was originally granted by DRMS on January 11, 2016. Updates to the milling process as described in TR-09 were approved in March 2017. Supporting information for the mill recertification included mill design discussion; mill construction, modification, and test operations; water and slurry handling systems and environmental protections; chemical handling and containment systems; tailing chemistry; and water quality at the tailings embankment. This revision is currently in progress.
					TR-16 July 2021	N/A	N/A	N/A	Approved	This revision requested approval to construct two equipment storage warehouses and a security building at the mine entrance, place temporary lineout buildings on the surface, construct a vehicle washdown area near the mechanic shop, and place temporary generators and a 10,000-gallon fuel tank on the surface. Reclamation Plan and bond was updated under TR-16 as well.
				Amendment 2 Filed 3Dec2021	N/A	Quarterly and Annually	Quarterly	In Agency Review	The scope of Amendment 02 is limited to expanding the affected lands boundary in Governor Basin to accommodate disturbance associated with construction of a refuge chamber and secondary escapeway. Also, the permit documents were updated to incorporate changes made through various Technical Revisions (TRs) that have been submitted and approved since the permit was last amended in 2015.	
	P-2015-003	3/31/2015	Governor Basin Exploration NOI	N/A		Annual	N/A	operational	Drill site has been reclaimed and we are awaiting final approval from DRMS before we can close out this NOI.	
CDPHE	CO-0000003	1Aug2013	Point Source Discharge to Sneffels Creek, Surface Water via Outfall 002A	Modification 5 31Aug2018	Administratively Continued	Monthly DMRs, Quarterly (WET test)	Bimonthly, Quarterly	under CDPHE review	Modified in 2018 to add Outfall 002A at the end of Mine Water Pond #3 and to accommodate new 5-stage passive mine water treatment system. Anticipate renewal in 2024 following basin hearing in 2023.	

Agency	Permit	Original Permit Date	Purpose	Key Modification(s)/ Date	Expiration Date	Reporting Requirements	Monitoring Requirements	Status	Comments
	COR-040289	19Sept2012	Storm water	Permit # changed from COR040273 to COR040289 30Sep2021	Administratively Continued	Quarterly Inspections, Annual Report to CDPHE (15Feb)	Quarterly	CDPHE is in the process of renewing general permit COR-04000.	
	CO-0246283	Active	Potable water	N/A	N/A	N/A	N/A	N/A	Potable water system is actively maintained for the mine and mill under the direction of a third-party Operator in Responsible Charge.
	APEN (Mine site)	1Nov2021	Air Quality	N/A	N/A	N/A	N/A	Under agency review	An updated APEN was submitted to the APCD to reflect changes to the operation after start up. The mine remains permit exempt at 180,000 tons per year of ore mined.
ACOE	SPK-2012-00953	22Apr2014	Nationwide 44 for Revenue Pond	N/A	N/A	N/A	N/A	Operational	NWP 44, replaced lost Revenue Pond WOTUS with Mine Water Pond #1
EPA	HW Generator ID # COR00024182 (mine site)		Management and disposal of hazardous waste	N/A	N/A	N/A	N/A	Operational	The mine is a very small quantity generator of hazardous waste.
	HW Generator ID # COR000255471 (assay lab)		Management and disposal of hazardous waste	N/A	If requested by HMWMD	Weekly inspections of 180-day waste storage area	operational		Assay lab is a small quantity generator of hazardous waste, which requires a more robust management program.
USFS/BLM	Fringe Lease	In 45-day, public notice – ends 26Dec2021	Allows access to adjacent claims for locatable minerals on FS lands	N/A	N/A	TBD	TBD	In public notice period	The USFS noticed the fringe lease on 11/19/2021. Once the notice period is up the leases will be issued
Ouray County	CR 361 & 26A Maintenance Agreement	10Oct2018	Road Use	N/A	31Dec2022				Allows OSMI to use and maintain CR 26 and 361 year-round
Ouray County	Waste rock for road gravel	7Oct2014	Provides for use of waste rock on County Roads	N/A	N/A	Annual SPLP	Annual SPLP		This activity was approved by DRMS in TR-09. Annual SPLP analysis required

Source: OSMI, 2021

Amendment 01

The regulations associated with hard rock mining and reclamation are described and consolidated in the Mineral Rules and Regulations of the Colorado Mined Land Reclamation Board for Hard Rock, Metal, and Designated Mining Operations (July 15, 2019). These Rules detail the requirements for initial and ongoing permitting of a mining operation. The following sections describe the various DRMS permitting actions since Amendment 1 to the permit was approved in 2015.

In August 2015, DRMS approved Amendment 01 to OSMI's Section 112d permit, which requested the following.

- Incorporated TRs 1 through 6 into the permit
- Initially sought approval to reprocess materials in Governor Basin and as a result extended the permit boundary in Governor Basin. However, this part of Amendment 01 was rescinded during adequacy review
- Increased the affected lands boundary at the Revenue Portal area

Technical Revision 8

On July 5, 2016, the DRMS approved Technical Revision 8 (TR-08) to Amendment 1 of DRMS Permit M-2012-032. The objective of TR-08 was to manage mine water through a bioreactor and subsequent infiltration to groundwater to eliminate Outfall-001A. The WQCD permits group did not approve TR-08. OSMI continued to discharge to groundwater until the current mine water treatment system could be constructed (Section 22.1.12).

Technical Revision 9

OSMI filed Technical Revision 9 (TR-09) with DRMS on February 7, 2017. TR-09 included:

- Construct new buildings as proposed during a mine restart
- Tailings blended with waste rock for aggregate use, which would provide for more compactable road base and create space on site
- Revised Water Quality Monitoring Requirements

The original TR-09 application included mill discharge treatment and management. On March 14, 2017, OSMI withdrew this portion of TR-09 and received DRMS approval on March 16, 2017.

Technical Revision 10

OSMI filed TR-10 in August 2018. TR-10 included:

- Construct a five-stage passive mine water treatment system (different from the system permitted under TR-09) with surface water discharge at a new industrial wastewater outfall (Outfall 002A) as permitted by the WQCD under CDPS Permit No. CO-0000003, Modifications #4 and 5
- Construct a new monitoring well (GW-4) to monitor the passive treatment system (note GW-4 was later abandoned pursuant to TR-12)
- Relocate a diesel tank to a less congested area of the mine site

Outfall 002A and the five-stage passive treatment system was approved as Modifications #4 and 5 to CDPS permit CO-0000003 on July 31, 2018, effective August 31, 2018. DRMS approved TR-10 in September 2018.

Technical Revision 11

OSMI filed TR-11 in May 2020. TR-11 included:

- Updates to the site water quality monitoring program, including sampling stations, sampling schedule, and analyte list.
- Placement of substrate materials from the passive mine water treatment pilot plant within the monitored permit boundary.
- Incorporation of a waste storage pad and enclosure into the list of structures within the permit boundary and include this structure in the updated Reclamation Plan and bond.
- Updates to the Reclamation Plan (Exhibit E) and Reclamation Plan Map (Map F-1) to address minor modifications to topsoil placement and vegetation plans and to incorporate the waste storage pad and enclosure.

Permit documents updated as part of this revision included the Reclamation Plan (Exhibit E), the Reclamation Plan Maps (F-1 and F-1a), Reclamation Costs (Exhibit L), and Map C-6 (Cross Sections).

DRMS approved TR-11 in October 2020.

Technical Revision 12

OSMI submitted TR-12 in March 2021 and requested approval for replacement of groundwater monitoring well GW-04 with a new well GW-04R. Replacement of GW-04 was in response to the discovery of historic organic residue in the well and a DRMS request for Corrective Action and Revisions in February 2021. OSMI determined that GW-04 was inadvertently drilled through an area that once contained the machine shop for the site. During adequacy review, OSMI and DRMS agreed that there was no suitable location for replacement well GW-04R and, as an alternative, approved monthly visual monitoring for leaks along the out-slope of Mine Water Pond #3. OSMI plugged and abandoned GW-04 in November 2021 and provided documentation to the State Engineers office and DRMS.

DRMS approved TR-12 in September 2021.

Technical Revision 13 and 14

OSMI submitted TR-13 to DRMS in March 2021 to address Reclamation Bond updates and building modifications. At the request of DRMS, OSMI withdrew TR-13 and incorporated the updates proposed under TR-13 as Amendment 02. OSMI submitted Amendment 02 to DRMS on December 3, 2021.

OSMI submitted TR-14 to DRMS in April 2021. This revision updated to the Environmental Protection Facility (EPF) certification plan for the new Reagent Room portion of the mill filter building extension (permitted under TR-09). These updates include the reasoning, characteristics, construction, operation, and reclamation measures associated with the Reagent Room.

DRMS provided conditional approval of TR-14 with the need for final inspections of the Reagent Room. Final DRMS inspections will occur once work on the Reagent Room is complete.

Technical Revision 15

OSMI submitted TR-15 to DRMS in June 2021. TR-15 related to recertification of the mill. Certification of the mill was originally granted by DRMS on January 11, 2016. Updates to the milling process as described in TR-09 were approved in March 2017. However, DRMS rescinded its certification of the mill due to changes that were made post 2017. Supporting information for the mill recertification

included updated mill design; mill construction, modification, and test operations; water and slurry handling systems and environmental protections; chemical handling and containment systems; tailing chemistry; and water quality at the tailings storage facilities.

DRMS conditionally approved TR-15 on July 21, 2021. OSMI expects final DRMS approval once the mill is fully commissioned, and the Reagent Room certified.

Technical Revision 16

OSMI submitted TR-16 in July 2021 and requested approval to construct two equipment storage warehouses and a security building at the mine entrance, place temporary lineout buildings on the surface, construct a vehicle washdown area near the mechanic shop, place temporary generators and a 10,000-gallon fuel tank on the surface, and update the reclamation bond.

DRMS approved TR-16 and OSMI is currently constructing the infrastructure permitted by TR-16.

Amendment 02

Per DRMS Rules, a full permit amendment is required when there is a change in the affected lands boundary (i.e., the permit boundary) or when there is a significant change in the reclamation plan for a mine site. DRMS required Amendment 02 because the secondary escapeway and refuge chamber constructed in Governor Basin was partially constructed outside the permit boundary. This activity was completed under prior management. DRMS issued a notice of violation to OSMI for causing disturbance outside the permit boundary.

OSMI appeared before the Mined Land Reclamation Board in August 2021 and reached a settlement with the agency to submit a permit amendment to expand the boundary in Governor Basin to incorporate the disturbance areas that were located outside the boundary.

The scope of Amendment 02 is:

- Expand the boundary in Governor Basin by approximately 1.16 acres to incorporate the emergency escapeway and refuge chamber.
- Incorporate commitments made as part of TRs 8 through 16.
- Update the Environmental Protection Plan (EPP) to address the mill and new reagent room.
- Update Exhibits A through U as well as supporting documentation; and
- Update site drawings.

OSMI submitted Amendment 02 to DRMS on December 3, 2021, and the application was deemed complete and filed by DRMS on December 13, 2021 and DRMS announced a decision date of May 17, 2022. OSMI received no objections to the permit application during the public comment period. .

20.1.2 CDPHE – Colorado Discharge Permit System

The mine currently holds Colorado Discharge Permit System (CDPS) Permit No. CO-0000003, which authorizes surface water discharge from Mine Water Pond #1 to Sneffels Creek via Outfall-001A and from Mine Water Pond #3 via Outfall 002A. At this point in time, only discharge from Outfall 002A is occurring.

The Revenue Tunnel Portal discharges mine water through two 8-inch HDPE pipes to the five-stage passive mine water treatment system (permitted under TR-10). In accordance with permit conditions, OSMI conducts bi-monthly, monthly, and quarterly effluent sampling. The current CDPS permit expired on August 31, 2018. OSMI filed the renewal application on February 20, 2018, 180 days in advance

of the expiration date as required by the regulations. The permit is administratively continued by the WQCD through its expected renewal in 2024.

On November 23, 2016, OSMI filed a Termination Application with WQCD for Outfall-001A. This termination followed OSMI's implementation of TR-08, which requested the transfer of discharge to a bio-reactive treatment system with groundwater infiltration (effective September 8, 2016) and eliminated discharge through Outfall-001A. In June 2017, the WQCD denied the Termination Application under its interpretation that the discharge to groundwater was ultimately making its way to Sneffels Creek as a point source discharge and required a permit. This resulted in an enforcement action against OSMI. To settle the enforcement action WQCD requested OSMI submit a Permit Modification application for Permit No CO-0000003 to modify certain aspects of the permit, including construction of an expanded five-stage passive water treatment system and addition of a new Outfall-002A.

OSMI submitted the permit modification on October 25, 2018. WQCD issued a modified permit in August 2018 just before the permit was administratively continued. The enforcement action by WQCD resulted in a Compliance Order on Consent (COC), which was finalized on October 18, 2018. The COC allowed OSMI to construct the upgraded five-stage passive water treatment system over two years along with a defined startup period following construction to allow the system to reach operational performance.

OSMI completed construction of the treatment system in January 2021. As of November 2021, all permit limits are being met with the treatment system and OSMI submitted a final report to WQCD and the COC was closed in February 2022.

The mine also maintains a CDPS General Permit for stormwater discharge (Permit No. COR-040289, former Permit No. COR040273). This permit requires a Storm Water Management Plan (SWMP) and routine inspections and annual reporting. The site SWMP was updated in November 2021 and inspections and reporting are up to date.

Lastly, because the mine has more than 25 employees, the site is considered a public water supply and maintains a potable water treatment system that supplies freshwater to the administration building and mill at the mine site. The system is permitted as a non-transient, non-community, groundwater Public Water System (PWS) under permit number CO-0246283.

20.2 Environmental Study Results

Environmental studies for the Project were originally completed and approved in 2012 as part of the original M-2012-032 permit application. As noted above, Amendment 02 to Permit No. M-2012-032 was submitted on December 3, 2021 and deemed complete by DRMS on December 13, 2021. As part of the permit amendment process, relevant environmental studies were updated to reflect current operating conditions.

DRMS requires prescriptive environmental information during the permitting and amendment process. Relevant exhibits of environmental and social significance in the DRMS 112(d) permit were updated as part of Amendment 02 and include:

- EXHIBIT C Facility/Mine Maps
- EXHIBIT D Mine Plan
- EXHIBIT E Reclamation Plan

- EXHIBIT F Reclamation Plan Maps
- EXHIBIT G Water Information
- EXHIBIT H Wildlife Information
- EXHIBIT I Soils Information
- EXHIBIT J Vegetation Information
- EXHIBIT K Climate Information
- EXHIBIT L Reclamation Costs
- EXHIBIT U Designated Mining Operation Environmental Protection Plan

Geochemical and leachability testing of tailings and waste rock is completed on a routine basis. To date, all samples have displayed results below regulatory limits for leachability and acid generating and there is no indication of acid rock drainage at the Revenue Tunnel.

20.2.1 Baseline Water Quality

Baseline water quality data includes samples collected in support of the current 112(d) permit, data collected pursuant to the CDPS permit, and supplemental data collected to assess ambient stream conditions. Table 20-2 presents inactive sampling stations, location, frequency, purpose, and status. Table 20-3 presents the area-wide and site locations for baseline and compliance sampling for surface water and groundwater. Inactive baseline surface water and underground water sampling locations include:

Table 20-2: Inactive Site Water Quality Sampling Station Summary

Map ID	Location	Frequency	Purpose
SW-8	Sneffels Above Ruby	Monthly / Quarterly	Baseline / Internal
SW-9	Saint Sophia's Basin	Singular	Baseline
SW-10	Humboldt Discharge	Singular	Baseline
SW-11	Virginus Central	Singular	Baseline
SW-12	GB Main North Branch	Singular	Baseline
SW-13	GB Conversion Downstream	Singular	Baseline
SW-14	Virginus SE Talus Slope	Singular	Baseline
UG-1	Yellow Rose Vein	NA	Baseline / Compliance
UG-3	Atlas/Cumberland Composite	NA	Baseline / Compliance
UG-6	Three Level Virginus Portal Discharge	NA	Baseline / Compliance

Source: OSMI

Table 20-3: Active Area-Wide Water Quality Sampling Station Summary

Map ID	Location	Frequency	Purpose	Current Status
Surface Water				
OF001	Outfall-001A	Bimonthly / Quarterly	Compliance	Active Permit (No discharge)
OF002	Outfall-002A	Bimonthly / Quarterly	Compliance	Active Permit (Continuous Discharge)
SW-1	Atlas Creek	Quarterly	Baseline / Internal	Active Information only
SW-2	Sneffels Below Governor Basin Confluence / Above Atlas Mill	Quarterly	Baseline / Internal	Active Information only
SW-3	Revenue Seep	Quarterly	Baseline / Internal	Active
SW-4	Sneffels Downstream of Revenue Outfall 002A	Quarterly	Baseline / Internal	Active Information only
SW-15	Sneffels Upstream of Revenue Permit Boundary	Quarterly	Internal	Active Information only

Map ID	Location	Frequency	Purpose	Current Status
SW-16	Confluence of Atlas Mine Drainage and Sneffels Creek	Quarterly	Internal	Active Information only
SW-17	Sneffels above Governor Basin and Below Ruby Trust	Quarterly	Baseline / Internal	Active Information only
SW-21	Sneffels above Camp Bird Mine	Quarterly	Baseline/ Internal	Active Information only
Groundwater				
GW-1A	Near Atlas Pile - Shallow	Quarterly	Compliance	Active
GW-1B	Near Atlas Pile - Deep	Quarterly	Compliance	Active
GW-2A	Upstream Revenue Pile - Shallow	Quarterly	Compliance	Active
GW-2B	Upstream Revenue Pile - Deep	Quarterly	Compliance	Active
GW-3R	Replacement well for GW-3A	Quarterly	Compliance	Active
GW-3B	Downstream Revenue Pile - Deep	Quarterly	Compliance	Active
Underground				
UG-2	Revenue Tunnel Upstream of Yellow Rose	Quarterly	Baseline / Compliance	Active
UG-4	Revenue Tunnel Upstream of Atlas/Cumberland	Quarterly	Baseline / Compliance	Active
UG-5	Revenue Tunnel Portal	Quarterly	Baseline / Compliance	Active
UG-7	Revenue Tunnel below Yellow Rose	Annually	Baseline / Composite	Active
UG-8	Revenue Tunnel below Atlas/Cumberland	Quarterly	Baseline / Composite	Active
UG-9	Revenue Tunnel below Terrible	Annually	Baseline / Composite	Active
UG-10	Revenue Tunnel above Terrible	Quarterly	Baseline / Composite	Active

Source: OSMI 2021

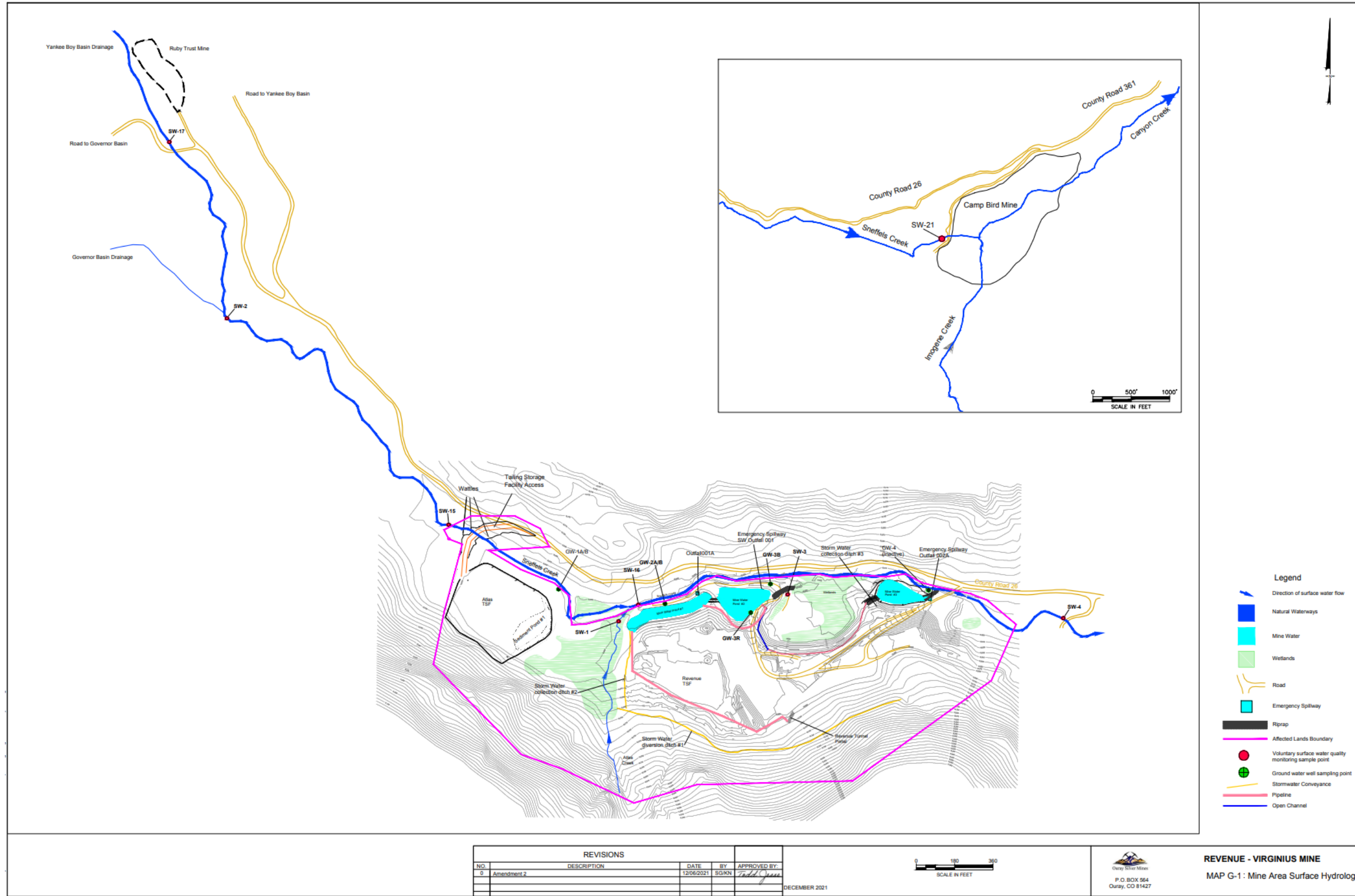

REVISIONS				
NO.	DESCRIPTION	DATE	BY	APPROVED BY
0	Amendment 2	12/06/2021	SGRN	<i>[Signature]</i>

DECEMBER 2021



REVENUE - VIRGINIUS MINE
 MAP G-1: Mine Area Surface Hydrology

Source: OSMI, 2021 (Exhibit G / Amendment 02)

Figure 20-1: Area-Wide Surface Water and Groundwater Sample Locations

Surface Water

OSMI currently monitors water quality at eight surface water locations, descriptions of which are provided in Table 20-4. These locations also are shown on Figure 20-1.

Sneffels Creek, the stream that runs along the northern boundary of the permit area is considered impaired by the State of Colorado and is listed as the 303(d) impaired water based on zinc, cadmium, and, potentially, lead loading from the entire watershed. Background water quality was monitored by OSMI at Outfall 001A on a biweekly basis prior to September 2016 for dissolved metals, temperature, and pH. Quarterly monitoring parameters include total metals. Outfall-001A met most permit effluent limits under CDPS permit number CO-0000003, with the exception of regular exceedances for lead, zinc, and cadmium, and occasionally copper. These exceedances triggered Notices of Violation from WQCD and initiated the permitting of the five-stage passive mine water treatment system.

In 2018, OSMI permitted a second outfall, Outfall 002A and ceased discharging from Outfall 001A. During this time water was diverted into a bioreactor and discharged to groundwater. Monitoring well GW-3 was used to assess whether water quality in groundwater met groundwater standards until the five-stage passive mine water treatment system could be constructed. During 2020 and 2021, the five-stage passive mine water treatment system was constructed, and discharge via Outfall 002A started in May 2021. Between May and October 2021, OSMI commissioned the new treatment system and as of November 2021, the water discharging from Outfall 002A is achieving permit limits, including WET limits. Table 20-4 presents a summary of water quality data from newly permitted Outfall 002A.

Table 20-4: Outfall 002A Water Quality Data

Analyte	Units	Minimum	Maximum	Average	Non-detect Count	Sample Count
Arsenic, total recoverable	mg/L	0.0016	0.0101	0.0040	4	4
Bicarbonate as CaCO ₃	mg/L	51.3	51.3	51.3	1	1
Cadmium, potentially dissolved	mg/L	0.00015	0.00227	0.00077	17	17
Cadmium, total	mg/L	0.000651	0.008	0.003	4	4
Carbonate as CaCO ₃	mg/L	2	2	2	1	1
Chromium, total recoverable	mg/L	0.0005	0.0027	0.0011	4	4
Chromium, Trivalent Total Recoverable	mg/L	0.005	0.005	0.005	4	4
Copper, potentially dissolved	mg/L	0.0008	0.0102	0.0022	17	17
Copper, total	mg/L	0.00114	0.0144	0.0073	4	4
Cyanide, WAD	mg/L	0.003	0.003	0.003	17	17
Dissolved Chromium, Hexavalent	mg/L	0.005	0.005	0.005	5	5
Hydroxide as CaCO ₃	mg/L	2	2	2	1	1
Iron, total recoverable	mg/L	0.06	5.59	0.81	17	17
Lead, potentially dissolved	mg/L	0.0003	0.179	0.018	17	17
Lead, total	mg/L	0.03	0.235	0.046	17	17
Manganese, potentially dissolved	mg/L	0.356	1.53	0.762	17	17
Mercury, total	mg/L	0.0002	0.0002	0.0002	16	16
Mercury, total (low level)	ng/L	0.3	4.2	2.0	4	4
Oil and Grease	mg/L	1.9	1.9	1.9	2	2
pH (lab)	s.u.	7.8	8.5	8.12	17	17
Total Dissolved Solids	mg/L	200	264	230	5	5
Total Suspended Solids	mg/L	5	126	17	17	17
Silver, potentially dissolved	mg/L	0.0001	0.00017	0.0001	17	17
Total Alkalinity	mg/L	51.3	51.3	51.3	1	1

Analyte	Units	Minimum	Maximum	Average	Non-detect Count	Sample Count
Zinc, potentially dissolved	mg/L	0.0278	0.646	0.233	17	17
Zinc, total	mg/L	0.173	0.63	0.35	4	4
pH (field)	s.u.	7.63	9	8.3	0	25
Water Temperature (field)	deg. C	0.1	15.2	7.42	0	25
Flow (field) 1	CFS	0.0305	1.84	0.881	0	25

Notes: All non-detect values included at the method detection limit

1 - Flow measurements based on staff gauge readings flow is also monitored and reported by continuous monitor and reported on discharge monitoring reports.

Groundwater

OSMI monitors groundwater quality at six wells (GW-1A, GW-1B, GW-2A, GW-2B, GW-3R, and GW-3B) on the mine site. Wells GW-1A (shallow) and GW-1B (deep) are located at the western edge of the permit boundary to monitor the constructed Atlas TSF. Wells GW-2A (shallow) and GW-2B (deep), adjacent to Mine Water Pond #1, and GW-3R (shallow) and GW-3B (deep), adjacent to Mine Water Pond #2, are in place to monitor groundwater quality down gradient of the Revenue TSF. Groundwater at the site is of high quality, meeting groundwater quality standards.

Mine Water

In addition to the monitoring wells on the surface, OSMI monitors mine water quality via five underground (UG) water sample points. Table 20-2 lists the underground sampling points and their descriptions. Underground locations are sampled to characterize source water locations to better understand water quality as it enters the five-stage passive mine water treatment system.

20.2.2 Results of Geochemical Studies of Waste Rock and Tailings

Waste Rock

The majority of the waste rock generated at the Mine is used to backfill mined out stopes. However, a certain amount of rock from development activities is brought to the surface where it is crushed and sized for use as road base. The waste rock generated by the mine is generally inert with no evidence of acid generation. Prior to 1999, SVL Analytical in Kellogg, Idaho analyzed waste rock samples from the Revenue Mine. Four samples were taken: one from the north end of the waste rock pile, one from the south end and two other samples from the low-grade stockpile that existed at that time. The pH of the waste rock samples was 8.33 and 8.22, respectively and zinc levels were low. The leachate analysis indicated the waste rock does not leach metals nor is it acid generating.

In March of 2017 as part of TR-09, DRMS approved the use of a waste rock/tailings blend for sale as road base or other construction material. TR-09 approval requires OSMI to sample waste rock on a routine basis and subject the material to the synthetic precipitation leachate procedure (SPLP). Since 2014, OSMI has analyzed 9 samples of waste rock. A summary table of waste rock analysis from pre-2014 and 2014 through 2021 is provided in Table 21.4. These data demonstrate that waste rock generated by the mine remains non-acid generating.

Similar to waste rock, tailings also are non-acid generating. As a condition of TR-15, DRMS requested that the tailings generated at the mill be tested for SPLP and Toxic Characteristic Leachate Procedure (TCLP) prior to the tailings being placed on either the Revenue or Atlas TSF. As of December 2021, OSMI has received one sample result on its tailings and the sample was below both the SPLP and

TCLP regulatory limits for leachability. Results of SPLP for the waste rock and tailings are provided in Table 20-4 and Table 20-5, respectively.

Table 20-5: Waste Rock Synthetic Precipitation Leachate Procedure Results

Analyte	Units	Pre-existing Waste Rock 6/27/2014	6/27/2014	7/19/2016	7/26/2017	8/5/2019	10/2/2019	7/20/2020	6/29/2021	8/23/2021
Aluminum (1312)	mg/L	0.13	0.26	0.73	0.31	0.33	0.1	0.59	0.307	0.349
Antimony (1312)	mg/L	0.0114	0.0033	0.0009	0.02	0.0039	0.0144	0.003	0.00303	0.00415
Arsenic (1312)	mg/L	0.0024	0.0012	0.003	0.01	0.0091	0.0045	0.0035	0.0125	0.00993
Barium (1312)	mg/L	0.0074	0.18	0.01	0.15	0.0534	0.122	0.191	0.108	0.118
Beryllium (1312)	mg/L	ND	ND	ND	ND	ND	ND	ND	ND	ND
Bicarbonate as CaCO3	mg/L	35	24.00	13.80	17.00	28.1	27.6	13.5	15.5	16.9
Boron (1312)	mg/L	ND	ND	0.01	0.03	ND	ND	ND	ND	ND
Bromide (1312-DI)	mg/L	0.185	1.97	ND	ND	1.14	0.101	0.553	ND	0.37
Cadmium (1312)	mg/L	ND	ND	ND	ND	ND	ND	ND	ND	ND
Calcium (1312)	mg/L	12.6	14.20	9.60	9.30	9.9	14.2	7.5	11.7	12.2
Carbon, total organic (TOC) (1312-DI)	mg/L	ND	ND	ND	ND	ND	ND	ND	ND	ND
Carbonate as CaCO3	mg/L	11	15.00	27.50	4.20	ND	ND	3.7	ND	ND
Chloride (1312-DI)	mg/L	ND	ND	ND	ND	ND	ND	ND	ND	ND
Chromium (1312)	mg/L	ND	ND	ND	ND	ND	ND	ND	0.00072	ND
Cobalt (1312)	mg/L	ND	ND	0.00	0.00	ND	0.00005	ND	0.000099	ND
Conductivity @25C (1312-DI)	umhos/cm	116.0	133.0	91.5	70.3	78.5	112	54.1	91.0	87.0
Copper (1312)	mg/L	0.0065	0.0016	ND	ND	0.0013	ND	ND	ND	0.0015
Fluoride (1312 DI)	mg/L	0.69	0.17	0.11	0.14	ND	ND	0.1	ND	ND
Hardness as CaCO3 (1312)	mg/L	33	38	25	24	27	37	20	32	33
Hydroxide as CaCO3	mg/L	ND	ND	ND	ND	ND	ND	ND	ND	ND
Iron (1312)	mg/L	ND	ND	0.09	0.03	ND	ND	ND	ND	ND
Lead (1312)	mg/L	0.0018	0.0004	0.0011	0.021	0.0001	0.0375	0.0003	0.00058	0.00223
Lithium (1312)	mg/L	ND	ND	ND	ND	0.014	ND	ND	ND	ND
Magnesium (1312)	mg/L	0.4	0.50	0.30	0.20	0.5	0.3	0.2	0.61	0.49
Manganese (1312)	mg/L	0.0112	0.0080	0.0038	0.0046	0.0112	0.0177	0.0035	0.00686	0.00916
Mercury (1312)	mg/L	ND	ND	ND	ND	ND	ND	ND	ND	ND
Molybdenum (1312)	mg/L	0.059	0.003	0.001	0.04	0.0025	0.0454	0.0027	0.0088	0.0111
Nickel (1312)	mg/L	ND	ND	ND	ND	ND	ND	ND	0.0016	ND
Nitrate (1312 DI)	mg/L	0.08	0.17	0.06	0.16	ND	1.75	0.07	4.5	3.33
Nitrate/Nitrite as N (1312-DI)	mg/L	0.08	0.17	0.06	0.21	ND	1.75	0.07	4.46	3.33
Nitrite as N (1312-DI)	mg/L	ND	ND	ND	0.05	ND	ND	ND	ND	ND
Nitrogen, ammonia (1312-DI)	mg/L	ND	ND	0.64	0.15	ND	ND	ND	ND	0.06
pH	units	8.7	8.80	9.50	9.50	9.2	8.9	9.3	9	9.1
pH measured at	C	23.8	23.80	23.30	21.60	23.50	19.50	20.80	20.9	20.6
Phosphorus, ortho dissolved (1312-DI)	mg/L	ND	ND	ND	ND	ND	ND	ND	ND	0.014
Phosphorus, Total (1312-DI)	mg/L	ND	ND	ND	ND	0.01	ND	3.1	1.6	ND
Potassium (1312)	mg/L	3.7	3.50	1.50	3.10	2.9	3.50	42	70	1.39
Residue, Filterable (TDS) @180C (1312)	mg/L	60	70.00	58.00	46.00	48	74.00	ND	ND	58
Residue, Non-Filter (TSS) @180C (1312)	mg/L	ND	ND	ND	ND	ND	ND	ND	ND	ND
Selenium (1312)	mg/L	0.0002	0.001	ND	0.0003	0.0008	0.0004	ND	ND	ND
Silica (1312)	mg/L	4.3	4.60	7.70	5.60	5.4	3.70	5	5.5	5.70
Silver (1312)	mg/L	0.00019	0.00	ND	ND	ND	0.0001	ND	ND	ND
Sodium (1312)	mg/L	0.9	2.50	1.80	1.40	2.1	1.7	1.5	4.44	3.53
Strontium (1312)	mg/L	0.052	0.27	0.20	0.25	0.188	0.205	0.217	0.358	0.468
Sulfate (1312-DI)	mg/L	8.75	11.40	1.54	6.32	7.26	17	3.28	4.4	4.48
Thallium (1312)	mg/L	ND	ND	ND	ND	ND	ND	ND	ND	ND
Tin (1312)	mg/L	ND	ND	ND	ND	ND	ND	ND	ND	ND
Total Alkalinity	mg/L	46	40.00	41.30	21.10	28.1	27.6	17.2	16.9	16.9
Uranium (1312)	mg/L	ND	ND	ND	ND	ND	ND	ND	ND	ND
Vanadium (1312)	mg/L	ND	0.00	0.00	0.00	0.001	ND	0.0019	0.00136	0.00067
Zinc (1312)	mg/L	0.01	0.00	ND	0.01	0.006	ND	0.007	ND	ND

Tailings

Tailings will be placed in one of two tailings storage facilities (TSFs), the Revenue TSF and the Atlas TSF. Under the terms of the existing permit that allows placement of tailings in the old Revenue Pond area and Atlas Waste Piles, tailings must be inert and nonhazardous as defined by SPLP results at or below groundwater quality standards. The geochemistry of tailings is discussed in Exhibit U of the existing DRMS 112(d) permit (M-2012-032). Table 20-6 presents the SPLP results for tailings generated during mill commissioning in September 2021. The results demonstrate compliance with the terms of TR-15.

Table 20-6: Tailings SPLP Results from Mill Commissioning

Parameter	Units	Standard	Tailings, February 2015	Tailings, October 2021
Aluminum (1312)	mg/L	5	0.56	0.232
Antimony (1312)	mg/L	Report	0.0083	0.00778
Arsenic (1312)	mg/L	0.1	0.012	0.00840
Barium (1312)	mg/L	Report	0.0588	0.809
Beryllium (1312)	mg/L	0.1	ND	ND
Bicarbonate as CaCO ₃	mg/L	Report	28.4	28.3
Bismuth (1312)	mg/L	Report	ND	NA
Boron (1312)	mg/L	0.75	0.01	ND
Bromide (1312)	mg/L	Report	ND	NA
Bromide (1312-DI)	mg/L	Report	0.434	ND
Cadmium (1312)	mg/L	0.001	ND	ND
Calcium (1312)	mg/L	Report	14.6	12.2
Carbon, total organic (TOC) (1312-DI)	mg/L	Report	ND	1.3
Carbonate as CaCO ₃	mg/L	Report	ND	ND
Chloride (1312-DI)	mg/L	2	ND	ND
Chromium (1312)	mg/L	0.1	ND	ND
Cobalt (1312)	mg/L	Report	0.00013	0.000062
Copper (1312)	mg/L	0.00865	ND	ND
Fluoride (1312 DI)	mg/L	2	0.24	0.20
Hardness as CaCO ₃ (1312)	mg/L	Report	39	34
Hydroxide as CaCO ₃	mg/L	Report	ND	NA
Iron (1312)	mg/L	1	0.29	ND
Lead (1312)	mg/L	0.0435	0.0199	0.00397
Lithium (1312)	mg/L	Report	ND	ND
Magnesium (1312)	mg/L	Report	0.7	0.86
Manganese (1312)	mg/L	1.62731	0.1082	0.0870
Mercury (1312)	mg/L	0.01	0.0002	ND
Molybdenum (1312)	mg/L	Report	0.0413	0.0123
Nickel (1312)	mg/L	0.05024	ND	ND
Nitrate (1312 DI)	mg/L	Report	1.09	ND
Nitrate/Nitrite as N (1312-DI)	mg/L	100	1.09	ND
Nitrite as N (1312-DI)	mg/L	Report	ND	ND
Nitrogen, ammonia (1312-DI)	mg/L	Report	0.8	0.86
Phosphorus, ortho dissolved (1312-DI)	mg/L	Report	0.01	ND
Phosphorus, Total (1312-DI)	mg/L	Report	0.04	0.104
Potassium (1312)	mg/L	Report	5.9	6.51
Residue, Filterable (TDS) @180C (1312)	mg/L	Report	110	62
Residue, Non-Filter (TSS) @180C (1312)	mg/L	Report	ND	ND
Selenium (1312)	mg/L	0.0046	0.0008	ND
Silica (1312)	mg/L	Report	ND	3.4

Note: ND = Not Detected, NA = Not Analyzed
 Source: Lewicki 2015, Appendix 2 and ACZ Sample L69171-01 10/05/21

20.3 Community Involvement

OSMI engages with local stakeholders on a regular basis with respect to re-opening of the mine. OSMI works closely with local government to perform avalanche mitigation and winter maintenance on CR 361 and has facilitated community meetings to advance access for winter recreationalists. In conjunction with the Uncompahgre Watershed Partnership (UWP) and Trout Unlimited (TU), OSMI helped fund reclamation of the historic Atlas Mill upstream of the permit boundary. In addition, in 2022, OSMI in partnership with TU and UWP, will be performing reclamation on historic waste rock piles and mine drainage in Governor Basin. These projects serve to improve the ambient water quality in Sneffels Creek, which ultimately benefits the mine from water discharge permitting standpoint.

The mine also provides materials to local government entities and remediation projects. The inert nature of the waste rock generated by the mine, makes this material suitable for gravel, road base, and for remediation projects. There is currently an aggregate agreement in place with Ouray County allowing the use of waste rock on as road base, and boulders were recently provided for the Uncompahgre Watershed Partnership Atlas Tailings Bank Stabilization effort currently underway on Sneffels Creek.

Other community-based programs include leasing water rights to the Ouray Ice Park to maintain the ice climbing feature that makes Ouray a popular winter destination for ice climbers all over the world. OSMI is active with the Ouray visitor's center and provides rock samples for kids as well as mining equipment for displays.

Once in full production the mine is expected to provide approximately 150 to 175 direct jobs, making it the largest employer and taxpayer in Ouray County. Additionally, those jobs will be among the highest paying in the county with an average salary of approximately US\$90,000 per year. It is expected that the mine will draw employees from Ouray, Montrose, and San Juan counties given the small population and housing constraints in Ouray County.

20.4 Operating and Post Closure Requirements and Plans

The DRMS 112(d) designated mining operation permit (M-2012-032) includes the updated closure plan and associated costs in the Reclamation Plan, Reclamation Plan Map and Reclamation Costs, which are found in Exhibits E, F and L, respectively.

These plans were updated per Amendment 02, which was submitted in December 2021. The post-reclamation use of the permit area is a combination of commercial and wildlife habitat/rangeland. Exhibit E Reclamation Plan identifies which buildings will remain on site post-mining and which buildings will be demolished.

20.4.1 Post-Closure Water Management

The water draining from the Revenue Tunnel will continue to be treated in the five-stage passive mine water treatment system. The system was designed to be low maintenance and to be able to operate post-closure. The CDPS permit will need to remain in place until OSMI can demonstrate that there is no reasonable potential for the water to exceed a water quality standard.

Other sediment ponds will be removed or will be allowed to remain in place to capture sediment until native vegetation can be established. The material for pond backfill will come from the general regrading of the site during reclamation. Similarly, the collection ditches will be removed once the vegetation of disturbed mine areas is established.

20.4.2 Tailings Management Area

The two TSFs will be reclaimed sequentially over the course of the mine life, minimizing the amount of TSF pile that is unreclaimed at any given time. Each TSF will be built using trucks dumping tailings and waste rock that is then pushed into a lift by a dozer. Each lift will be compacted by equipment driving along it. Since the TSFs will be constructed of a blend of angular waste rock from mining and fine mill tailings, the compaction of lifts will minimize settling. Each TSF is expected to be approximately 20% waste rock and 80% tailings. Surface water runoff seeping through the piles is prevented through compaction. The tailings will be placed on the waste piles in 6-inch lifts, and then compacted to 94% of maximum dry density. Prior to the end of each summer, 12 inches of topsoil will be placed along the TSF slope for the year, seeded, and mulched.

20.4.3 Shafts

Each shaft will have its concrete foundation on the surface removed, a seal installed, and the area topsoiled and revegetated. After removing the casing 3 ft below ground surface and removing the concrete pad, each shaft will be covered by a steel plate and a 6-inch concrete slab will be poured. The seal will be buried with either available overburden and soil generated from excavation or regraded into the local topography. Twelve inches of topsoil (saved from construction) will be placed on top of each shaft's backfilled area. The estimated disturbance areas associated with shaft reclamation is 100 ft x 100 ft per shaft (.23 acres) with the exception of Governor Basin, which is 1.39 acres. The proposed shafts are accessible in the summer from Forest Service roads and roads on private claims.

20.4.4 Plant Site and Facilities

Reclamation will include the removal of select buildings and other structures. The following structures will be removed at the Revenue Portal area:

- Diesel storage and filling station
- Propane storage A
- Propane storage B
- Propane storage C
- Ventilation Fan
- Underground warehouse and shop
- Reagent Room
- Waste storage building and secondary containment
- Tailing thickener tank
- Materials storage buildings
- Crusher and retaining wall
- Structures at Governor Basin
- Secondary Escapeway

Several buildings will remain on site post-closure, which include:

- Administration building
- Railyard and battery charging
- Air Compressor Building
- Concentrator and Filter Building
- Electrical Building

- Access road retaining wall
- Outfall 002A Sampling Hut

The facilities that will remain onsite have 12-inch concrete foundation, which will remain as part of the commercial, post-mine land use. Foundations of buildings that will be dismantled will be broken up and capped with native materials and covered with topsoil and vegetated.

20.4.5 Portal

There are three portal areas that will be reclaimed at Revenue: the underground storage room, the mill, and the Revenue Tunnel portal. The underground storage room and mill portal will be backfilled with 25 ft of waste rock. The face of the backfill slope will be covered with topsoil and seeded along with all other disturbed areas. The Revenue Tunnel portal will not be backfilled due to the mine water discharge that flows year around. Instead, a steel bat gate will be welded into place at the entrance to the tunnel.

20.5 Closure Monitoring

The site will remain accessible for closure monitoring such as visual observation, groundwater sampling, and surface water sampling as deemed necessary by DRMS and the WQCD. It is anticipated that quarterly monitoring of reclamation will be required for at least one year after reclamation is complete.

20.6 Reclamation and Closure Cost Estimate

The current reclamation bond required by DRMS is US\$517,219. Three additional bonds are also required for current operations with the first for US\$7,826.61 with DRMS for drilling under a Notice of Intent to Explore. The second from DRMS for drilling in Governor Basin for US\$3,526. The third bond for US\$5,000 is required by Ouray County for winter maintenance activities conducted by OSMI on County Road 361. All bonds are held by a fully funded certificate of deposit and are shown in Table 21-6.

Table 21-6: Current Reclamation Bonds

Required Bond Amount (US\$)	Agency	CD Amount (US\$)
517,219	Colorado Division of Reclamation Mining and Safety	517,219
7,826.61	Colorado Division of Reclamation Mining and Safety	7,826.61
3,526	Colorado Division of Reclamation Mining and Safety	3,526
5,000.00	Ouray County	5,000.00
Total		\$533,571.61

Source: OSMI, 2021

21 Capital and Operating Costs

The forecasted capital cost is estimated to be at a $\pm 15\%$ accuracy which is appropriate for a feasibility-level estimate.

21.1 Capital Cost Estimate

The cost estimate is broken down by area including mining, processing plant, surface mobile equipment, infrastructure and Engineering and Contracts. Capital costs were developed by OSMI and SRK. SRK reviewed the capital cost buildup and capital budgets for the mine, surface mobile equipment and infrastructure. The remaining capital does not include contingency. Freight has been included in the estimate. Capitalized preproduction costs are included for operating and G&A costs that occur in the 11-month pre-production/ramp up period.

21.1.1 Capital Cost Assumptions and Qualifications

The capital cost basis includes:

- First principal buildups
- OSMI budgeted capital items
- Vendor quotations on materials, supplies, equipment, and installation
- Estimates and allowances for items not specifically priced

The capital cost has the following exclusions:

- Taxes and duties have been excluded from this estimate
- Escalation has not been included in the estimate

Capital costs are based on Q4 2021 currency. All costs are expected to be incurred in US\$ so foreign exchange rates are not applicable.

Capital costs were developed with the assumption that OSMI will self-perform construction management and commissioning. In addition, operating costs during the pre-production / ramp up period, which include owner's costs for managing development activities, are included as pre-production capital. The pre-production period is estimated to be 8 months from January 1, 2022, through August 31, 2022, when a three-month ramp up occurs with production starting in December of 2022.

No Contingency has been included in the capital estimates as the majority of costs completions of previously estimated work are self-performed by OSMI.

21.1.2 Capital Cost Summary

A summary of capital costs for the LoM are listed in Table 21-1 summarizes the capital broken down by Project area and time they are incurred.

Table 21-1: Capital Summary (in US\$000's)

Description	Pre-Production	Ramp Up	Total Initial Capital	Sustaining Capital	Total Capital
Revenue Mine	(\$608)	\$0	(\$608)	\$0	(\$608)
Revenue Mill	(\$152)	(\$524)	(\$676)	(\$625)	(\$1,301)
Surface	\$0	(\$280)	(\$280)	\$0	(\$280)
Site Infrastructure	(\$250)	(\$1,500)	(\$1,750)	\$0	(\$1,750)
Engineering & Construction Contracts	(\$1,669)	(\$1,200)	(\$2,869)	(\$2,800)	(\$5,669)
Subtotal	(\$2,678)	(\$3,504)	(\$6,183)	(\$3,425)	(\$9,608)
Pre-Production Costs ⁽¹⁾	(\$11,381)	\$0	(\$11,381)	\$0	(\$11,381)
Subtotal	(\$14,059)	(\$3,504)	(\$17,563)	(\$3,425)	(\$20,988)
Contingency	\$0	\$0	\$0	\$0	\$0
Total Capital	(\$14,059)	(\$3,504)	(\$17,563)	(\$3,425)	(\$20,988)
Operating Costs During Ramp Up		(\$7,933)	(\$7,933)		
Net Revenue During Ramp Up		\$5,770	\$5,770		
Total Net Capital and Start Up Costs	(\$14,059)	(\$5,667)	(\$19,725)		

Source: OSMI, 2021

(1) Pre-Production Costs are detailed in Table 21-2.

The capitalized operating expense is categorized in Table 21-2.

Table 21-2: Pre-Production Capitalized Operating Cost (US\$000's)

Area	Cost
Revenue Mining	4,521
Revenue Milling	1,277
Maintenance	1,051
G&A	2,902
Surface Operating Costs	1,631
Total	\$11,381

Source: OSMI, 2021

21.1.3 Processing Plant Capital Cost Estimate

The majority of the upgrades to processing plant were incurred in the previous preproduction period construction activities. The following summaries include the remaining OSMI projects from the previous construction activities and further modification items identified by SRK on the recent site tour.

The cost for the processing plant, as described in the following sections, includes purchase of equipment and installation by OSMI and minor support by contractors.

Based on SRK's site visit and review of the current status of OSMI's process plant commissioning effort, SRK roughly estimates an additional Capex of US\$970,000 to complete the concentrator upgrades sufficiently to achieve production targets as itemized in Table 21-3.

Table 21-3: Concentrator Upgrade Costs

Cost Area	US\$
Apron Feeder	25,000
Primary Crusher Discharge Screen	20,000
Ball Mill Screens	25,000
Pb Flotation Reconfiguration	100,000
Zn Flotation Reconfiguration	100,00
Laboratory	300,000
Subtotal	570,000
Pb Tailing Thickener ⁽¹⁾	400,000
SRK Subtotal	970,000

Source: SRK, 2021

Notes:

¹ It is noted that because the plant tailings are thickened and filtered for dry stack disposal, the tailing thickener overflow and filtrate are recycled immediately back to the process water tank. In doing this, the lead and zinc flotation process water (and reagents) are commingled and could have a negative impact on flotation selectivity. In a conventional tailing disposal scenario, the tailings are discharged to a tailing pond and the effluent has an opportunity to “age” prior to being recycled back to the plant. If it turns out that the flotation selectivity is impacted by the commingling of lead and zinc flotation process water and immediate recycle back to the process, it is suggested that a lead scavenger tailing thickener be installed between the lead and zinc flotation circuits and separate process water tanks for lead and zinc flotation.

In addition, OSMI has included the items in Table 21-4 in their process plant Capex forecast which brings the total process plant Capex estimate to US\$1,301,000.

Table 21-4: Process Plan Capex Forecast

Cost Area	US\$
Ball Mill Motor	187,500
Tailing Thickener Enclosure	83,500
Laboratory Ventilation	60,000
OSM Subtotal	331,000
Total Capex Estimate	1,301,000

Source: SRK, 2021

Table 21-5: Process Plant Capital Summary Breakdown (US\$ 000's)

Mill Capital	Pre-Production	Ramp Up	Subtotal	Sustaining	Total
Ball Mill Motor	46.9	140.6	187.5		187.5
Tails Thickener Enclosure		83.5	83.5		83.5
Complete Assay Lab	35.0		35.0	25.0	60.0
Apron Feeder	25.0		25.0		25.0
Primary Crusher Discharge Screen	20.0		20.0		20.0
Ball Mill Screens	25.0		25.0		25.0
Pb Flotation Reconfiguration			-	100.0	100.0
Zn Flotation Reconfiguration			-	100.0	100.0
Laboratory		300.0	300.0		300.0
Pb Tailing Thickener			-	400.0	400.0
Subtotal Mill	151.9	524.1	676.0	625.0	1,301.0

Source: SRK, 2021

Note: Pre-production operating costs in the mill during the pre-production period are capitalized and summarized in Table 21-2. Sustaining costs for specific projects are noted in Table 21-5 and the remainder of sustaining cost is in operating costs.

Basis of Estimate

The primary capital costs are based on remaining costs on previous contractor bids, SRK estimates, and the OSMI updated budgets.

21.1.4 Mining Capital Cost Estimate

Significant preproduction work has occurred in the previous preproduction efforts through the end of December 31, 2021. The mining capital included herein is the remaining capital to first production. Capital after that point is partially capitalized and partial carried in operating costs. The majority of the work is to be self-performed by OSMI except where noted. The mining capital was developed based on a combination of quotations, first principles, and allowances. Mine equipment was purchased during the previous preproduction period. The total preproduction costs excluding operating cost that is capitalized (Table 21-2) is US\$3.7 million. Ramp up costs are US\$2.4 million for a total mining cost of US\$6.1 million. Ongoing development costs are carried in operating cost in the technical model.

Table 21-6: Mine Capital Cost Summary (US\$ 000's)

Item	Pre-Production	Ramp Up	Total	Notes
Air Doors	168		168	Purchase - install by OSMI
Alimak Rental, Critical Spares, Rail, Repairs and Training	120		120	
Diamond Drill	200		200	Purchase - OSMI budget price
Central Water system at Vault	120		120	parts and install by OSMI
Alimak #1 Timber and Hoist Installation	346		346	Contract
Alimak #1 Steel Set Fabrication	565		565	OSMI
Century Elevator	325		325	Contract
Hoist Design (Willis Spencer)	120		120	Contract
Hoist Materials	170		170	Purchase
#1 Shaft Hoist		2,000	2,000	Contract
#1 Shaft Timber & Rehab	1,600	400	2,000	Contract
Subtotal	3,733	2,400	6,133	

Source: OSMI, 2021

Note: Pre-production operating costs in the mill during the pre-production period are capitalized and summarized in Table 21-2. Sustaining costs for specific projects are noted in Table 21-6 and the remainder of sustaining cost is in operating costs. Mine development costs are carried as operating costs after the pre-production period.

21.1.5 Surface Capital Cost Estimate

The mobile equipment that supports the surface activities for the mine, mill, and tailings facility are included were purchased in the previous pre-production period. The only remaining purchase is the replacement of the Loader/D5 Dozer in November 2022 estimated to be US\$280,000.

21.1.6 Infrastructure Capital Cost Estimate

The infrastructure projects were substantially completed in the previous pre-production efforts through December 31, 2021. The remaining projects include an upgrade of power inputs with the local power company San Miguel Power Authority, 2 pole barns for storage, and additional space finish at the site and Ouray offices. The completion of the Winter TSF area is also included in this capital estimate. Table 21-7 summarizes the infrastructure capital.

Table 21-7: Infrastructure Capital Summary (US\$000's)

Site Infrastructure	Pre-Production	Ramp Up	Subtotal	Sustaining	Total
Upgrade Power Inputs with SMPA		1,500	1,500		1,500
Pole Barns (2)	150		150		150
Additional Office Space Finish (Ouray and Site)	100		100		100
Winter TSF		143	143		143
Total	250	1,643	1,893		1,893

Source: OSMI, 2021

21.2 Operating Cost Estimate

The operating cost estimate is broken down by area including mining, processing, G&A, and surface operating costs. Operating costs were estimated by OSMI. SRK has reviewed the operating cost build up and basis of estimates for mining, G&A, processing and surface operating costs. Contingency has not been included in the operating cost estimate. The estimate is based on Q4 2021 pricing. The operating costs have been updated to reflect the actual costs encountered in pre-production work prior to December 31, 2021. The operating costs have increased significantly from the 2018 FS in the areas of labor and supplies. The operating costs are in US\$. No escalation has been included in the operating costs for the LoM evaluation. The overall accuracy of the operating cost assumptions is estimated at $\pm 15\%$.

21.2.1 Operating Costs Assumptions and Qualifications

Foreign Exchange

All costs are estimated and quoted in US\$ so conversion of foreign exchange is not applicable.

Work Schedule

The process facility will operate on a 24 hour per day, 365-day basis with mill and mine operating costs based on an equivalent 337-day production period to account for delays and maintenance downtime. The mine will operate using two 10-hour shifts.

Wages and Salaries

Wages and salaries are built up with base salary or hourly rates multiplied by burden and, where appropriate, bonus. The base salary rates are based on OSMI established labor rates that were tested and increased during the previous pre-production period to acquire and retain personnel with the skill sets required for the OSMI project.

The base salary rate is multiplied by a burden of 38.7%, developed based on current OSMI labor rates (Table 21-8). The burden includes employment taxes and benefits including health care, long and short-term disability, life insurance and AD&D, workers compensation, 401-k employer match and supporting accounting charges. Significant bonuses are included in the rates for key production and management employees. The buildup is included in the OSMI budget based on the employee count in the budget month of production.

Table 21-8: Burden Cost Buildup

Item	LoM Value
Total Annual Salary	\$56,285,131
Employer Social Security	\$3,909,182
Employer Medicare	\$914,244
Federal Unemployment Insurance	\$27,493
State Unemployment Insurance	\$658,773
Total Annual Payroll Cost	\$61,794,823
Employer Share Labor Costs (US\$)	\$5,509,692
Employer Share Labor Costs (%)	8.92%
Other Burden Costs	
Employee and Employer Health Insurance	\$11,983,270
Workmen’s Comp	\$1,768,742
Employer 401k Contribution	\$4,237,846
Payroll Processing	\$416,600
Total Annual Other Burden Costs (US\$)	\$18,406,458
Total Annual Other Burden Costs (%)	29.79%
Total Burden Rate	38.70%

Source: OSMI (calculated by SRK), 2021

Fuel Costs

Fuel costs are not a substantive portion of the operating costs at this mine as it is primarily driven by electrical and air equipment. Fuel costs for the study are based on current bulk costs from local suppliers. The current diesel cost is US\$3.46/gallon. The gasoline price is US\$3.12/gallon.

Power Costs

Power is supplied to the site through an existing three phase 12.47 kV overhead powerline owned and operated by San Miguel Power Association. The line has a capacity of 3 MW. The rate for overhead powerline electricity is US\$0.071kWh, with an additional demand charge of US\$17/kw.

21.2.2 Operating Cost Summary

The operating cost summary is presented in Table 21-9 and amounts to US\$380/st, averaged over the LoM. Operating costs during the first five years of operations average US\$254/st of ore. Operating costs during the preproduction period are included in the capital cost estimate.

Table 21-9: Operating Cost Summary

Revenue Mine Operating Costs	LoM		First Five Years	
	US\$000s	US\$/t-RoM	US\$000s	US\$/t-RoM
Revenue Mining	\$100,799	\$175	\$88,450	\$187
Revenue Milling	\$34,653	\$60	\$28,392	\$60
Maintenance	\$13,130	\$23	\$11,199	\$24
G & A	\$50,621	\$88	\$38,365	\$81
Surface Operating Costs	\$20,220	\$35	\$16,816	\$36
Total Operating Costs	\$219,424	\$380	\$183,223	\$388

Source: OSMI, SRK 2021

21.2.3 Mining Operating Cost Estimate

The mining operating cost is primarily labor with expense for materials and equipment operations. The operating cost breakdown by activity is summarized in Table 21-10. The stoping cost is approximately 60% of the total mining cost. The mining operating costs includes labor rates adopted during the recent

preproduction period. A summary of the key unit cost drivers for the operating cost estimate as well as advance rates is included in Table 21-11. The drilling budget allows approximately 5,000 ft of drilling, logging, and sampling per year.

Table 21-10: Mining Operating Cost by Activity

Area	Capitalized Preproduction	Ramp Up	Production	Total	Remove Capitalized Cost	US\$/ROM ore st
Labor	3,430	2,753	56,118	62,301	58,871	102
Materials/Consumables	857	1,202	36,286	38,346	37,489	65
Equipment	173	125	2,821	3,120	2,946	5
Outside Services	60	0	360	420	360	1
Subtotal	4,521	4,081	95,586	104,187	99,666	173
Definition Drilling	0	0	1,132	1,132	1,132	2
Total	4,521	4,081	96,718	105,319	100,799	175

Source: OSMI, SRK 2021

Table 21-11: Mining Activity Costs and Productivities

	Item	Development Size			Unit Cost Summary Totals		Unit Cost Breakdown						
		Width (ft)	Height (ft)	Distance	Units	Unit Cost	Labor: Operations (\$/unit)	Materials: Ops: Drilling (\$/unit)	Materials: Ops: Blasting (\$/unit)	Materials: Ops: Ground Support (\$/unit)	Consumables (\$/unit)	Equipment Cost (\$/unit)	
Infrastructure Costs	#1 Shaft Hoisting				\$/ton	6							
	Secondary Shaft Hoisting				\$/shift	156							
	Cost for First Diesel Muck Train				\$/ton	4							
	Cost for Second Diesel Muck Train				\$/ton	0							
	Cost for Electri Man/Materials Train				\$/shift	187							
	Total tons per shift one train				tons/shift/train	280							
	Level Haulage				\$/ton	0							
Stoping	Resue Stopping: 5 Man Crew	1.5	6		\$/ton	103	52	2	28	4	13	3	
	Shrinkage Stopping	4	0		\$/ft	163	19	5	125	5	8	1	
	Shink Free pull	0	0		\$/ft	13	9	-	-	-	2	2	
Lateral Development	9x9 Track Drift	9	9		\$/ft	649	310	65	51	67	113	44	
	9x9 Track Drift - Jumbo	9	9		\$/ft	533	198	52	104	54	100	25	
	Level Siding	12	9		\$/ft	556	288	60	31	62	71	44	
	Drift Rehabilitation	2	9		\$/ft	386	192	38	10	43	76	27	
	Resue Stope Scram	4	8		\$/ft	492	206	77	64	52	74	18	
	Resue Stope Scram 01	4	8		\$/ft	554	275	77	52	52	74	24	
	Shrink Stope Scram	4	9		\$/ft	460	206	77	32	52	74	18	
	Alimak Raise 3x9 Station Scram	3	9		\$/ft	572	275	82	64	38	74	39	
	Alimak Raise 4x9 Station Scram	4	9		\$/ft	707	275	82	64	54	194	39	
	Alimak Raise 9x9 Station Scram	9	9		\$/ft	951	550	82	100	61	80	77	
	Alimak Raise 10x14 Station Scram	10	14		\$/ft	1,137	677	50	143	49	122	95	
	Alimak Raise Dog Holes	3	7		\$/ft	436	206	71	32	52	44	29	
	Alimak Standard Nest	10	14		\$/ft	871	516	71	108	52	51	73	
	Alimak Hoist Nest	10	14		\$/ft	898	516	71	108	52	78	73	
	Station Enlargement	12	7		ea	1,251	683	118	106	99	149	96	
	Shink Cut & Hog Pockets	6	8		ea	2,255	275	71	1,818	3	45	42	
		Alimak Installation				ea	2,303	2,303	-	-	-	-	-
		Switch Installation				ea	2,303	2,303	-	-	-	-	-
Vertical Development	Level Dump Raise	6	6		\$/ft	905	516	75	88	23	129	75	
	Alimak Muck Raise	4	4		\$/ft	664	310	56	90	19	144	45	
	Alimak Standard Raise	6	8		\$/ft	579	310	56	103	33	33	45	
	Alimak Hoist Raise	7	12		\$/ft	650	310	56	154	53	33	45	
	Alimak Finger Raise	6	6		\$/ft	757	413	75	112	29	70	58	
	Alimak Chute Raise	8	8		\$/ft	743	413	75	88	38	70	58	
	Carried Manway Raise	6	8		\$/ft	2,031	1,376	75	137	77	173	193	
	Resue Chute Raise	4	4		\$/ft	905	590	59	76	30	68	83	
	Service Manway Raise - Prep Set	6	12		\$/ft	1,923	1,240	67	197	66	212	142	
	Service Manway Raise - Carry Set 1	6	12		\$/ft	1,832	1,163	62	183	61	199	164	
	Service Manway Raise - Carry Set 2	6	12		\$/ft	1,381	768	62	183	61	199	108	
	Alimak Box Cut	7	12		\$/ft	3,792	310	56	3,342	21	33	30	
	Raise Sump Excavation	12	10		\$/ft	29	19	3	1	0	2	3	
	Raise Screening				\$/ft	205	115	10	7	49	7	16	
	Raise & Rail Rehab					102	66	5	-	20	3	9	
Timbering & Hoists	Timbering Standard Raise			25	\$/ft	714	288	26	-	29	332	40	
	Timbering Hoist Raise			25	\$/ft	714	288	26	-	29	332	40	
	Timbering Alimak Finger Raise			25	\$/ft	477	288	20	-	45	103	22	
	Timbering Carried Manway Raise			25	ea	1,037	288	26	-	45	638	40	
	Timbering Service Manway Raise			25	ea	64	288	20	-	45	248	40	
	Resue Chute Package				ea	4,359	2,303	204	-	356	1,172	324	
	Alimak Chute Package				\$/ft	4,820	2,303	204	-	356	1,633	324	
	Hoist Installation				\$/ft	-	-	-	-	-	-	-	
	Level Dump Pocket					7	4	0	-	0	1	1	
Start-Up Projects	Central Water System Installation	10	10	0	\$/ft	-	-	-	-	-	-	-	
	Hang 10" Compressed Air Line	0	0	0	\$/ft	-	-	-	-	-	-	-	
	Install 4/0 Cable in Mine and Power Center	10	10	0	\$/ft	-	-	-	-	-	-	-	
	Special Project	0	0	0	ea	2,303	2,303	-	-	-	-	-	
	Drill Program	0	0	0	\$/ft	12	10	-	-	-	-	2	

Source: OSMI, 2021

21.2.4 Processing Plant Operating Cost Estimate

The original processing plant operating cost estimates were originally developed by Lycopodium (Lycopodium, 2016), and were reviewed and updated by Barr as part of the design of the processing plant upgrades. OSMI has further updated these costs based on current 2021 Q4 costs and additional information gained during the pre-production period through December 31, 2021.

The process operating costs for the Project have been estimated under four functional headings:

- Labor - provided by OSMI based on its staffing plan
- Maintenance – based on Lycopodium’s PFS assumptions (Lycopodium, 2016)
- Operating consumables
- Power consumption

The process operating cost estimate is expressed in US\$ and is accurate within ±15%.

Quantities and cost data were compiled from a variety of sources including:

- Metallurgical testwork and process modeling
- Supplier quotations
- Information supplied by OSMI
- Lycopodium data from the 2016 PFS report
- First principles

The annual process operating cost is estimated at US\$34.7 million or US\$60/st of ore. A breakdown of the operating cost centers is summarized in Table 21-12.

Table 21-12: Summary of Operating Costs – Processing Area (US\$000’s)

Area	Capitalized Preproduction	Ramp Up	Production	Total	Remove Capitalized Cost	US\$/ROM ore st
Labor	1,207	728	17,340	19,275	18,068	31
Power	0	79	4,139	4,218	4,218	7
Reagents	0	31	1,651	1,683	1,683	3
Consumables	60	32	1,613	1,706	1,646	3
Parts/Repairs	0	42	996	1,037	1,037	2
Lab	10	16	403	429	419	1
Freight	0	54	2,556	2,610	2,610	5
Outside Services	0	93	4,880	4,973	4,973	9
Total	1,277	1,076	33,578	35,930	34,653	60

Source: OSMI, SRK 2021

Basis for Processing Plant Operating Cost Estimate

The process costs are presented in US\$ and are estimated on a pricing basis as of the fourth quarter of 2021.

The process operating cost estimate includes all direct costs associated with the Project to allow production of lead and zinc concentrate. The process operating costs commence from the RoM dump pocket.

Processing Plant Operating Cost Estimate Breakdown

Electrical Power

The process plant electricity consumption is determined based on the annual average running load, which is the annual average power draw. Table 21-13 separately lists consumption for areas not included in the processing plant, and these consumption values were provided by OSMI.

Electrical demand factors and utilization factors have been applied to the installed power to arrive at the annual average power draw, which is then multiplied by total hours operated per annum and the electricity price to obtain the plant power cost.

Electricity is provided by grid power. The power unit cost of US\$0.071/kWh as provided by OSMI has been used in the calculations. Demand charges shown in the table are based on April 2018 electric bill from San Miguel Power Association invoice, assuming demand charge of \$17/unit. Units assumed to be average plant load of 1,373 kW plus the load of the largest motor in the mill (air compressor) of 350 kW.

Table 21-13 summarizes the power consumption rates and costs per plant area. SRK did not adjust these costs consistent with the design. OSMI has included power costs based on this concept for the plant.

Table 21-13: Electrical Consumption and Costs (based on 91,390 st/y)

Area	Annual Average Operation Load (kW)	Annual Power Consumption (kW-hr)	Total Cost (US\$/st)	Cost/Year	Source
200 Area Transformer	321	2,246,714	\$1.74	\$159,403	Barr (usage) OSMI (unit cost)
300 Area Transformer	721	5,055,106	\$3.92	\$358,656	Barr (usage) OSMI (unit cost)
500 Area Transformer	182	1,467,987	\$1.14	\$104,153	Barr (usage) OSMI (unit cost)
800 Area Transformer	149	1,197,877	\$0.93	\$84,989	Barr (usage) OSMI (unit cost)
Demand Charges	1,723		3.85	\$351,527	Barr
Total Electrical Cost			\$11.58	\$1,058,527	

Source: Barr, 2018

Reagents

The reagents category (Table 21-14) covers those chemicals used in the processing of the ore within the processing plant. If used, water treatment plant reagents are not included. Laboratory testwork results were used where possible to determine the reagent consumption rates. In the absence of testwork data, reagent consumption rates are assumed based on generally accepted practice within the industry, and input from vendors.

Table 21-14: Reagent Costs (Based on 576,997 LoM st Processed)

Consumables	Consumption (lb/ton milled)	LoM Consumption (lbs)	Cost/lb (US\$/lb)	Cost LoM	Cost/ton Milled LoM (US\$)
Frother Oreprep F-549 - (Flotation)	0.24	138,479	\$2.10	\$290,806	\$0.50
Aerofloat 242 - (Flotation)	0.01	5,770	\$4.20	\$24,234	\$0.04
Aerophine 3418-A Collector - (Flotation)	0.02	11,540	\$6.07	\$70,047	\$0.12
Hydrated Lime	5.364	3,095,012	\$0.16	\$495,202	\$0.86
Zinc Sulfate	0.53	305,808	\$0.99	\$302,750	\$0.52
Sodium Metabisulfite	0.53	305,808	\$0.45	\$137,614	\$0.24
Flocculant AF-309 - (Tailings - Thickening)	0.063	36,351	\$2.00	\$72,702	\$0.13
Copper Sulfate	0.22	126,939	\$1.65	\$209,450	\$0.36
Sodium Isopropyl Xanthate	0.043	24,811	\$1.75	\$43,419	\$0.08
Totals and LoM Averages		4,050,519	\$0.41	\$1,646,224	\$2.85

Source: OSMI/SRK, 2021

Non-Reagent Consumables

The non-reagent consumables category covers all wear parts and consumable materials in the process plant except reagent which are described in the previous section. Consumables include liners and media for equipment such as crushers and mills, and filter press cloths. Previous data from the 2016 PFS (Lycopodium, 2016) were used for filter cloth. Rod mill and ball mill media consumption was based on experience assuming hardened steel rods and forged balls. Rod mill liner cost was assuming steel liners, based on our past experience and consistent with the recommendations in this report. OSMI has updated the costs, but in general the consumption and updated costs are summarized adequately in the Table 21-15.

Table 21-15: Non-Reagent Consumables Costs (Based on 91,390 st/y)

Consumables	Consumption (Units per Ton of Rod Mill Feed)	Annual Consumption	Unit Cost	Cost/Year	Source
#1 Jaw Crusher Fixed Liner		3.5 sets/yr	\$3,008	\$10,600	Lyco PFS
#1 Jaw Crusher Moving Liner		2 sets/yr	\$2,365	\$4,800	Lyco PFS
#2 Jaw Crusher Fixed Liner		3.5 sets/yr	\$8,460	\$29,600	Lyco PFS
#2 Jaw Crusher Moving Liner		2 sets/yr	\$9,000	\$18,000	Lyco PFS
Rod Mill Liners		0.7 sets/yr	\$40,000	\$28,000	OSMI
Rod Mill Grinding Media	0.9lb	90,810 lb	\$1,500 st	\$52,711	OSMI (cost)
Ball Mill Liners		0.5 sets/yr	\$40,000	\$20,000	OSMI
Ball Mill Grinding Media (forged)	0.8lb	80,700 lb	\$1,200 st	\$41,086	OSMI budget
Filter Cloth Conc (3 Units)		12 sets/yr	\$3,000/set	\$36,000	Lyco PFS
Filter Cloth Tailings (2 Units)		8 sets/yr	\$6,000/set	\$48,000	Lyco PFS
Total Consumables Costs				\$300,500	
Consumables Unit Cost				\$3.29/st	

Source: Barr, 2018

21.2.5 Maintenance Operating Cost

Maintenance operating cost includes all maintenance for the project and is primarily labor with a small allocation of consumables. The maintenance costs are summarized in Table 21-16.

Table 21-16: Maintenance Operating Costs (US\$000's)

Area	Capitalized Pre-Production Cost (US\$000's)	Ramp Up (US\$000's)	Operating Period (US\$000's)	LoM Cost (US\$000's)	Remove Capitalized Preproduction	Operating US\$/Tons Milled
Labor	987	527	12,033	13,547	12,560	21.77
Consumables	64	24	547	635	571	0.99
Total	1,051	551	12,580	14,182	13,131	22.76

Source: OSMI, SRK 2021

21.2.6 Surface Operating Cost Estimate

Operating costs were developed for surface operations through budgetary quotes or on a first-principals basis. The cost areas estimated include light vehicles, surface equipment, concentrate haulage and winter month access road operations. Costs are applied as lump, fixed monthly values during applicable periods of operation and are independent of production rate. The majority of the surface operating cost is incurred through concentrate haulage and surface equipment. Surface operating costs are summarized in Table 21-17.

Table 21-17: Surface Operating Costs (US\$000's)

Area	Capitalized Pre-Production Cost (US\$000's)	Ramp Up (US\$000's)	Operating Period (US\$000's)	LoM Cost (US\$000's)	Remove Capitalized Preproduction	Operating US\$/Tons Milled
Labor	620	223	7,868	8,712	8,092	14.02
Utilities	235	88	2,115	2,438	2,203	3.82
Consumables	135	31	2,278	2,444	2,309	4.00
Maintenance	473	230	5,617	6,319	5,846	10.13
Logistics	168	42	1,729	1,938	1,771	3.07
Total	1,631	614	19,606	21,851	20,220	35.04

Source: OSMI, SRK 2021

21.2.7 G&A Operating Cost Estimate

G&A costs were developed for the Project on a first principles basis and are inclusive of Project and corporate G&A costs. Costs include labor, utilities, IT, offices, insurance, health, safety, environmental and other miscellaneous expenses. The largest contributors to the G&A costs are labor and taxes. G&A costs are treated as fixed costs (i.e., independent of production rate). Ad Valorem and Severance taxes also flow through the G&A cost calculation, which provides a means for their deduction from other taxes. Overall G&A costs are summarized in Table 21-17.

Table 21-17: G&A Operating Cost Summary

Area	Capitalized Preproduction	Ramp up	Production	LoM Total w/ Capitalized	LoM Total Opex (Remove Capitalized)	US\$/st milled
Labor	1,651	893	23,785	26,328	24,678	\$42.77
Tax	150	83	13,135	13,367	13,217	\$22.91
Outside/Professional Services	562	204	6,505	7,272	6,710	\$11.63
IT	215	81	1,939	2,235	2,020	\$3.50
Environmental	89	48	1,225	1,363	1,274	\$2.21
Leases	135	51	1,217	1,403	1,268	\$2.20
Consumables/Supplies/Freight	100	63	1,392	1,555	1,455	\$2.52
Total	2,902	1,424	49,197	53,523	50,621	\$87.73

Source: OSMI, SRK, 2021

22 Economic Analysis

The indicative economic results summarized in this section are based upon work performed by SRK or received from OSMI and audited/modified by SRK. The results have been prepared in an economic model on a monthly and 100% equity basis, in constant Q4 2021 U.S. dollars (i.e., model costs and revenues are not escalated for inflation).

22.1 Principal Assumptions and Input Parameters

An economic model was prepared by OSMI. SRK audited the OSMI model and provided feedback and modifications to the model, as appropriate. Principal assumptions, which are consistent with standard industry practice, are summarized in Table 22-1.

Table 22-1: Basic Model Parameters

Description	Technical Input
Model Assumed Start Date	31-Jan-22
Preproduction Period	11 months
Ramp-up Period	3 months
Mine Life	75 months ⁽¹⁾
Mine Operating Days per Year	337 days per year ⁽²⁾
Mill Operating Days per Year	337 days per year ⁽²⁾
Designed Production Rate	273 st/d ⁽³⁾
Discount Rate	5%

Source: OSMI, 2018

⁽¹⁾ Inclusive of ramp-up period

⁽²⁾ 365 days/year adjusted for downtime

⁽³⁾ Effective daily throughput based on the 337 operating days per year

The model is based on a process definition for metal recovery into separate lead and zinc flotation concentrates. It is assumed that copper will be recovered into the lead concentrate and economic value associate with copper is assumed to be paid at the same price as lead.

22.2 Cash Flow Forecasts and Annual Production Forecasts

The following tables contain the production and cost information developed for the Project. Table 22-2, Table 22-3 and Table 22-4 summarize the estimated mine production, mill production and concentrate production, respectively, over the 75-month (approximately 6.25 year) reserve life.

Table 22-2: Mine Production Summary

Description	Value	Units
UG Ore Mined	577	kst
Daily Mining Output	253	st/d
Mill Feed Head Grade and Contained Metal		
Silver Grade	25.38	oz/st
Gold Grade	0.06	oz/st
Copper Grade	0.25	%
Lead Grade	4.93	%
Zinc Grade	2.13	%
Contained Silver Feed	14,645	koz
Contained Gold Feed	33.90	koz
Contained Copper Feed	2,832	klb
Contained Lead Feed	56,838	klb
Contained Zinc Feed	24,599	klb

Source: OSMI, 2022

Notes: 365 day per year basis (i.e., includes down time)

Table 22-3: Mill Production Summary

Description	Value	Unit
Total Ore Processed	577	kst
Daily Process Throughput	253	st/d
Overall Effective Silver Recovery ⁽²⁾	94.64	%
Overall Effective Gold Recovery ⁽²⁾	68.26	%
Overall Effective Copper Recovery ^{(2), (3)}	89.38	%
Overall Effective Lead Recovery ⁽²⁾	94.94	%
Overall Effective Zinc Recovery ⁽²⁾	93.30	%
Recovered Silver	13,860	koz
Recovered Gold	23.14	koz
Recovered Copper	2,532	klb
Recovered Lead	53,962	klb
Recovered Zinc	22,950	klb

Source: OSMI, 2022

Notes: 365 day per year basis (i.e., includes down time).

⁽¹⁾ Effective Recovery is (total recovered metal)/(total metal contained in feed); Actual modelled recovery is based on monthly average mill feed head grade ranges and the corresponding recovery as described in Section 13.4 in Table 13-32.

⁽²⁾ Modelling assumes no value for recovered copper.

Table 22-4: Concentrate Production Summary

Description	Value	Units
Copper Conc.	-	kst
Lead Conc.	41.07	kst
Zinc Conc.	16.72	kst
Overall Silver Payability	94.5%	%
Overall Gold Payability	92.1%	%
Overall Copper Payability	97.8%	%
Overall Lead Payability	94.0%	%
Overall Zinc Payability	66.9%	%
Payable Silver	13,099	koz
Payable Gold	21	koz
Payable Copper	2,475	klb
Payable Lead	50,727	klb
Payable Zinc	15,352	klb

Source: OSMI, 2022

A summary of the NSR for the Project is shown in Table 22-5. The terms used in the model for the sale of lead and zinc concentrates are based on a market study commissioned by OSMI for concentrate sales. The market study provided potential ranges of values that may be received by OSMI on key economic terms and are validated by the current offtake contracts.

The TEM assumes that payment terms are based on a schedule of 95% at delivery and 5% received 60 days after delivery.

Table 22-5: Net Smelter Return

Description	Units	Unit Value	Life of Reserve Value (US\$000's)
Metal Prices / Gross Revenue			
Silver	(US\$/oz)	23.84	312,223
Gold	(US\$/oz)	1,720	36,662
Copper	(US\$/lb)	0.98	2,414
Lead	(US\$/lb)	0.98	49,471
Zinc	(US\$/lb)	1.34	20,646
Pb Conc.			
Gross Revenue	US\$000's	N/A	397,189
Zn Conc.			
Gross Revenue	US\$000's	N/A	24,228
TC/RC Costs			
Pb Smelter Treatment	US\$/st conc.	\$181.44	(7,453)
Silver Refining	US\$/payable oz	\$1.00	(13,029)
Gold Refining	US\$/payable oz	\$9.00	(182)
Sb Penalty	US\$/st	\$17.08	(701)
Zn Smelter Treatment	US\$/st conc.	\$158.76	(2,655)
As Penalty	US\$/st	\$2.93	(49)
Net Conc. Revenue	US\$000's	N/A	397,348
Freight/Insurance			
Pb conc. Freight (10% Moisture)	US\$/wst	\$181.44	(8,198)
Zn Conc. Freight (10% Moisture)	US\$/wst	\$158.76	(2,920)
Insurance/Assay Costs	US\$/wst	\$27.22	(1,730)
Net Smelter Return	US\$000's	N/A	384,500

Source: OSMI, 2022

The following provides the basis of the modeled plan for this FS:

- A mine life of 75 months (roughly 6.25 years).
- Constant LoM metal prices of US\$23.84/oz Ag, US\$1,720/oz, US\$0.98/lb Pb, US\$0.98/lb Cu, and US\$1.34/lb Zn, which were based on median consensus forecasts compiled as of 12/23/21 by Bloomberg and as of 1/20/22 by BMO.
- Treatment/Refining charges, penalties and freight inputs per Table 22-5, as supported by an independent third-party report from Bluequest and offtake contracts.
- Third party private royalty input of 2% annual NSR to a maximum of US\$9. Once that has been paid a further potential 1% NSR if the silver price is above US\$60/oz, up to a maximum of an additional US\$9 million.
- Capital and operating costs described in Section 21
- Working capital assumptions:
 - 0-day delay to receive 95% of payable revenue from concentrate sales. Balance (5%) received after 60 days
 - Assume 30 days accounts payable (A/P) and 30 days consumable inventory will net each other out each year.

The economic results, shown in Table 22-6, indicate an after-tax NPV 5% of US\$108.8 million and an IRR of 179%. Capital payback is forecast as eight months. Total production costs (inclusive of sustaining capital) are forecast to be US\$15.48/oz payable silver excluding any by-product credits. The NSR from Au, Pb and Zn result in a by-product credit of US\$2.92/oz of payable silver, reducing the total production cost estimate to US\$12.55/oz payable silver on a byproduct basis.

Table 22-6: Life-of-Mine Indicative Pre-Tax and After -Tax Economic Results (in US\$000's)

Revenue Allocation				
Payable Gross Revenue by Metal	Value	% of Gross		Wtd. Average Prices
Silver	312,223	74%	23.84	US\$/ozAg
Gold	36,662	9%	1,720	US\$/ozAu
Copper	2,414	1%	0.98	US\$/lbCu
Lead	49,471	12%	0.98	US\$/lbPb
Zinc	20,646	5%	1.34	US\$/lbZn
Total	421,417	100%		
Estimate of Cash Flow				
	Value	% of G.Rev.		
Total Gross Revenue	421,417	100%		
Smelting / Refining	(24,069)	-6%		
Freight / Insurance	(12,849)	-3%		
NSR Pre Royalty	384,500	91%		
Royalties	(7,690)	-2%		
Total Net Revenue	376,810	89%		
Total Operating Cost	(219,424)	-52%		
Operating Profit (EBITDA) Pre-tax Cash Flow	157,386	37%		
Total Tax	(10,063)	-2%		
After Tax Cash Flow	147,323	35%		
LoM Capital	(9,608)	-2%		
Pre-tax Undiscounted Free Cash Flow (US\$000)	136,398	32%		
After-tax Undiscounted Free Cash Flow (US\$000)	126,335	30%		

Discounted Cash Flow and Returns	
	After-Tax
Undiscounted Free Cash Flow (US\$000)	\$126,335
NPV US\$000 @ 5.0%	\$108,755
IRR	178.72%
Break Even Months	8

Source: OSMI, 2022

The cumulative after-tax cash flow profile is presented in Figure 22-1. The cash flow profile shows steady positive cash flow over the life of the Mineral Reserve with initial production targeting higher grade portions of the reserve and therefore producing higher monthly production of payable silver, gold, lead and zinc.

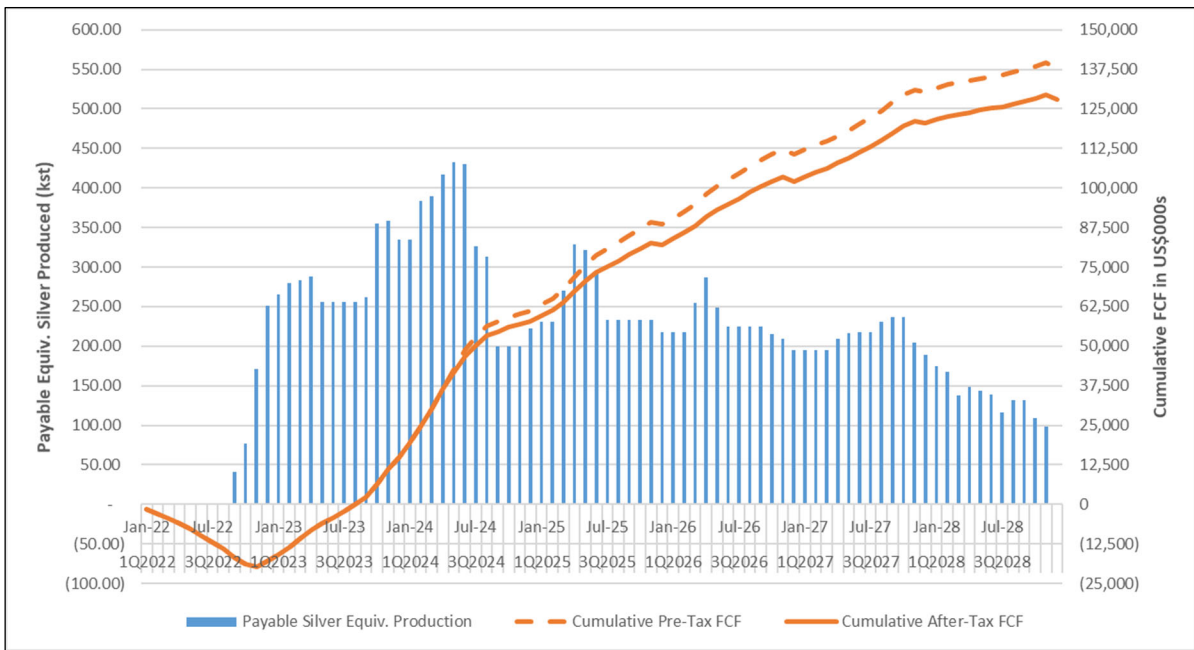

Source: OSMI, 2022

Figure 22-1: Project After-Tax Metrics

All in Cash Cost calculations are summarized in Table 22-7.

Table 22-7: Life-of-Mine Total Production Cost Contribution ⁽¹⁾

Description	US\$000's	US\$/oz Ag	US\$/oz AgEq
Mining Operating Costs	100,799	7.70	5.70
Processing Operating Costs	34,653	2.65	1.96
Maintenance	13,130	1.00	0.74
G&A Operating Costs	50,621	3.86	2.86
Surface Operating Costs	20,220	1.54	1.14
Freight/Insurance	12,849	0.98	0.73
TC/RC	24,069	1.84	1.36
Royalties	7,690	0.59	0.43
Subtotal Operating Costs	264,031	20.16	14.93
Sustaining Capital	9,608	0.73	0.54
Total Production Costs After Sustaining Capital	273,639	20.89	15.48
By-Product Credits	-109,194	-8.34	N/A
Subtotal Operating Costs After By-Product Credits	164,445	12.55	N/A
Total Production Costs with By-Product Credits	164,445	12.55	N/A
Payable Ag Life of Reserve (koz)		13,099	
Payable Ag Equivalent Life of Reserve (koz)		17,680	

Source: OSMI, 2022

⁽¹⁾ All costs inclusive of ramp-up period.

Numbers may not add due to rounding and production tax cash flows paid after mining is completed

22.3 Taxes, Royalties and Other Interests

The Project will be subject to a variety of taxes at the state and federal level, including the following:

- Estimated combined Federal and State income taxes of 25%
- State severance taxes of 2.25% on “Gross Income” after a US\$19 million per year deduction and subject to statutory limits and offsets including but not limited to the State Ad Valorem tax
- State Ad Valorem taxes of 4.3% on 25% of the “Ad Valorem Assessed Value”, subject to statutory limits and offsets

Operating costs incurred prior to the start of production are amortized over the life of the reserve. New capital associated with Project development is assumed to be depreciated over a seven-year straight line schedule. Existing credits impacting the tax calculation include the following:

- Property, plant and equipment (PPE) subject to 7-year depreciation of US\$9.6 million
- PPE subject to 7-year depreciation of US\$0.6 million
- Net operating losses of US\$29.5 million

22.3.1 Ownership Structure

On May 8, 2014, Fortune Revenue obtained a 12% interest in the Project and operating authority for the mine, mill and surface operations via its wholly owned subsidiary FRSM. On October 1, 2014, FRSM acquired the balance of 100% ownership of the mine through an asset purchase agreement supported by senior secured financing (the “PFA”) from Lascaux Resource Capital Fund I LP (LRC) via LRC-FRSM, LLC (LRC-FRSM). FML was the guarantor on the PFA. After default on the PFA, on July 17, 2015, FML and LRC-FRSM, LLC entered a Master Restructuring Agreement. As part of the MRA, 100% ownership of FRSM transferred to LRC-FRSM II, LLC, also held 100% by LRC. On July 21, 2015, FRSM changed its name to OSMI. OSMI currently owns and operates the site. Also, as part of the MRA settlement, the prepay facility was kept outstanding for potential beneficial tax structuring but LRC- FRSM deferred all required payments. In 2018, the interest and penalties of the facility were eliminated, and only the primary metal delivery obligations remain. As the facility is owned by a related

party it is superficial to the economics of the Project and therefore is excluded from the analysis of this report. On December 27, 2018, Aurcana completed a reverse takeover transaction pursuant to a plan of arrangement under the CBCA (the “Arrangement”) with OSMI, which holds the “Revenue-Virginius Mine” located in Colorado, pursuant to an arrangement agreement dated September 20, 2018, between the Company and LRC-FRSM LLC and LRC-FRSM II LLC (collectively, the “LRC Group”). Under the Arrangement, Aurcana acquired all of the issued and outstanding shares of common stock of OSMI from the LRC Group on a debt free basis in exchange for newly issued common shares of Aurcana.

On March 31, 2020, pursuant to a definitive agreement between OSMI and Caldera Mineral Resources (“Caldera”), the Company closed the acquisition of the Blue Grass claim located on the Virginius Vein contiguous to the Revenue-Virginius Mine. In return, Caldera received certain non-core claims of the Revenue-Virginius Mine from OSMI. The swap of mineral properties has been considered a non-monetary transaction for which the fair value of the asset received was not reliably measurable. As a result, the original carrying value of the properties given up by the Company has been allocated to the Blue Grass claim acquired from Caldera. Upon the completion of the swap, Blue Grass claim became a part of the Revenue-Virginius Mine.

22.4 Sensitivity Analysis

A standard deterministic sensitivity analysis was done on the model to show the impact to changes in key drivers to the Project economics, namely commodity prices, silver prices as a standalone, operating costs (mining, processing, G&A and surface costs) and LoM capital costs. The results are presented in Figure 22-2. As shown in Figure 22-2, the Project is the most sensitive to changes in commodity price. For every 10% change in commodity prices, the Project after-tax NPV (5%) changes by approximately US\$30 million. The silver price drives approximately 2/3 of this change (i.e., changes in only the silver price, leaving other prices the same, results in a change in NPV5% of approximately US\$20 million). For every 10% change in capital and operating costs, the after-tax Project NPV (5%) changes by approximately US\$0.8 million and US\$16 million, respectively.

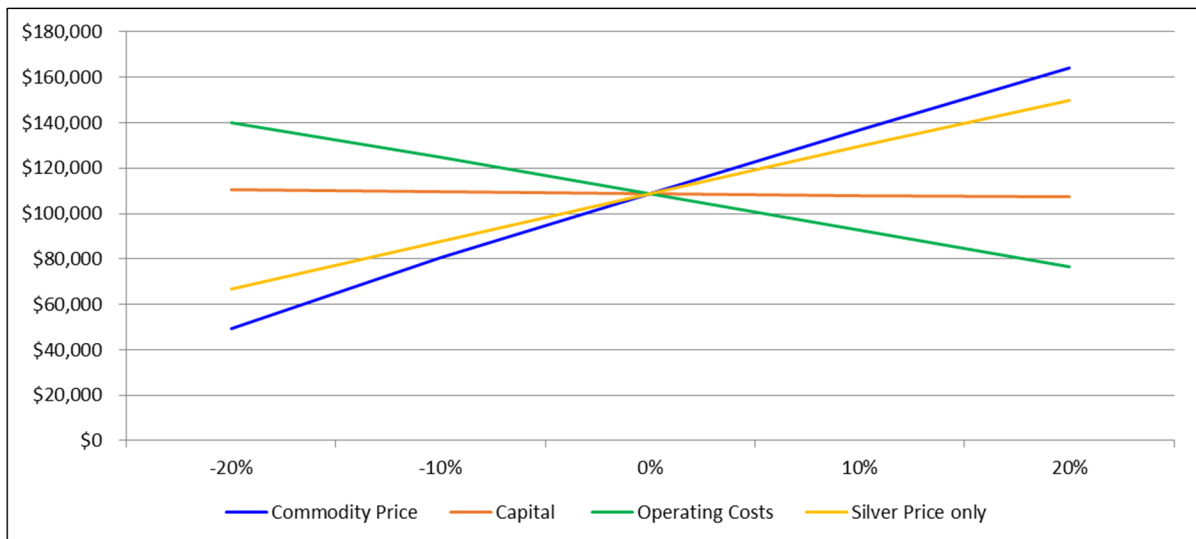

Source: OSMI, 2022

Figure 22-2: After-Tax NPV (5%) Sensitivity Chart (US\$000's)

23 Adjacent Properties

The Project is located in the Mount Sneffels District and there are many adjacent past producers. The Smuggler, a past producer, is located on the Telluride side of the ridge to the south of the Virginius Vein system; the Camp Bird Mine is located approximately 1.3 miles to the east of the Project; and the Idarado Mine is located approximately 5 miles southeast of the Project. In addition, there are numerous named and unnamed adits within a 5-mile radius of the Project, many of which are abandoned.

Mineralization on these properties is not indicative of mineralization at the Project and there are no immediately adjacent properties that have any bearing on the Project. Other ownership on mines which have not been explored including Hidden Treasure a past producer on the far southeast see map in Figure 23-1.

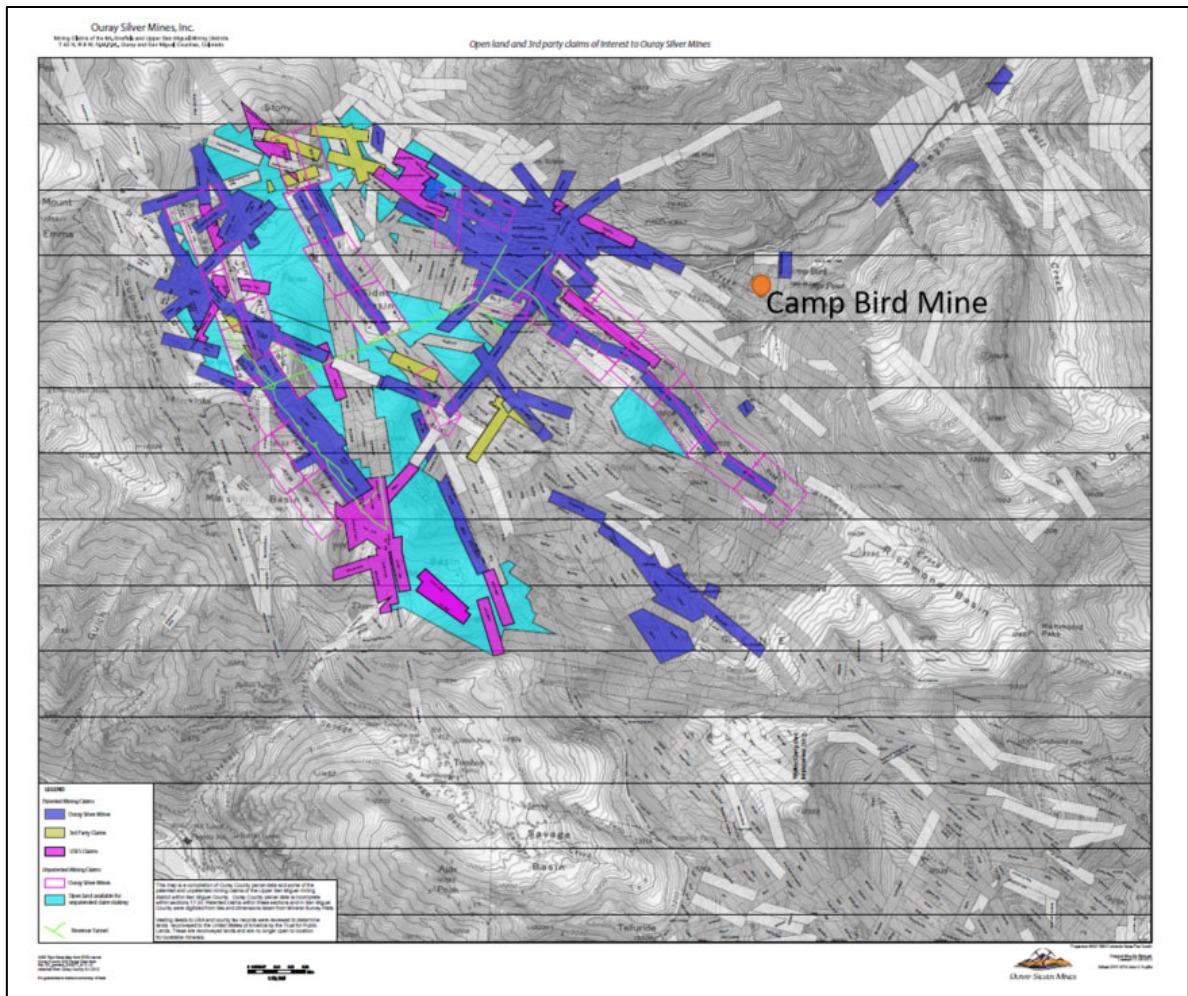

Source: OSMI, 2017, modified by SRK

Figure 23-1: Location of the Camp Bird Mine Relative to the OSMI Boundaries

Mineralization on these properties is not indicative of mineralization at the Project and there are no immediately adjacent properties that have any bearing on the Project.

24 Other Relevant Data and Information

24.1 Project Implementation

24.1.1 Current Status and overview

OSMI initiated pre-production activities at the Project during 2021 that included the surface, processing and underground projects. The Project has remaining tasks required to allow the mine to begin to produce consistently at designed rates. The OSMI plan will primarily be self-performed with some contract efforts required.

The program will include small projects on surface facilities, minor processing plant modifications, and a major effort in the underground mine. The key construction activities are as follows:

- Alimak #1 hoist installation including iron works. (UG - contract)
- Development of the mining areas on the 1800, 1500, and 900 levels (UG)
- Miscellaneous surface projects as discussed in Chapter 18
- Additional Mill Upgrades and optimization

OSMI will self-perform the majority of the activities. Outside firms will be utilized to complete the installation of the Reed-Hub elevator and backup generation project. The Project schedule is developed and will take approximately eight months with a three month ramp up to full production. The onsite team will manage the remaining preproduction tasks.

Engineering has been completed and the majority of the materials are on hand or available. OSMI has an ERP system that is used to manage materials at the warehouse in Ouray and delivery to the mine site. There is no need for additional equipment for the next phase of work. OSMI leases a warehouse that is located eight miles from the mine site. The warehouse site includes inside and outside storage areas. There are two loading/unloading stations with forklift access. The warehouse site is easily accessible with adequate room for tractor/trailer deliveries. All incoming materials will be received at the Ouray warehouse location, inspected and compared against the receiving reports to ensure accurate and complete delivery of goods.

Pre-commissioning of the mill process, mine hoisting and secondary egress system will be completed by OSMI personnel with mechanical, electrical and instrumentation support from the contractors that installed the equipment. Mill pre-commissioning testing has been completed with the OSMI team.

Plant commissioning has been done in multiple phases and there is still remaining commissioning and tuning of the system that will be required with the adjustments recommended by SRK. Commissioning will be completed by OSMI employees with mechanical, electrical and instrumentation support from the contractors that installed the equipment. Vendor support will be arranged if necessary.

24.1.2 Recruiting, Onboarding and Training

OSMI has developed and implemented a successful recruiting, onboarding and training program for employees that is key to the overall success and sustainability of this Project. OSMI previously ramped to a significant number of employees and then went through a layoff to manage cash and to evaluate necessary steps to focus on the key tasks remaining.

The overall organization chart can be seen in Figure 24 and the ramp up staffing to full levels is shown in Table 24-1.

The following outlines OSMI procedures for the recruiting, on-boarding and training of new employees. The objective of this is to ensure OSMI is hiring qualified candidates and that those candidates are properly trained for their specific job requirements, thereby ensuring a safe working environment and enhancing employee retention. The Organization Chart shown in Figure 24 details those positions considered to be key to the success of the Project.

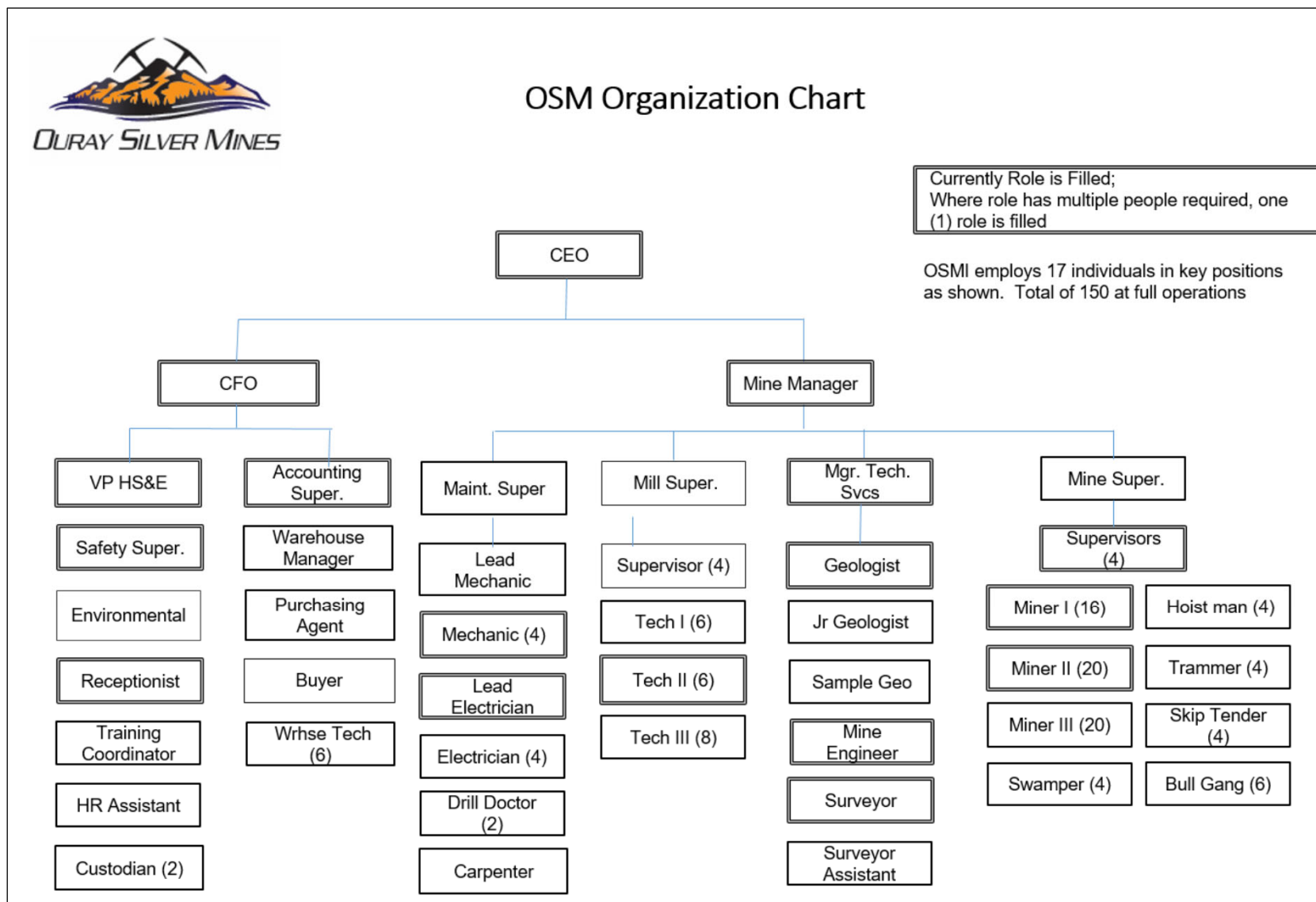

Source: OSMI, 2022

Figure 24-1: OSMI Organization Chart

Table 24-1: OSMI Project Staffing by Period

Position	Max Number	Year 1 - Number of People in Position during Ramp Up											
		1	2	3	4	5	6	7	8	9	10	11	12
Administrative													
CEO	1	1	1	1	1	1	1	1	1	1	1	1	1
VP Human Resources	1	1	1	1	1	1	1	1	1	1	1	1	1
HR Assistant	1		1	1	1	1	1	1	1	1	1	1	1
CFO	1	1	1	1	1	1	1	1	1	1	1	1	1
Accountant/Assistant Controller	1	1	1	1	1	1	1	1	1	1	1	1	1
Safety Superintendent	1	1	1	1	1	1	1	1	1	1	1	1	1
Training Coordinator	1		1	1	1	1	1	1	1	1	1	1	1
Administrative Assistant	1	1	1	1	1	1	1	1	1	1	1	1	1
Technical													
Manager of Tech Services	1	1	1	1	1	1	1	1	1	1	1	1	1
Mine Engineer	1	1	1	1	1	1	1	1	1	1	1	1	1
Geologist	1	1	1	1	1	1	1	1	1	1	1	1	1
Jr. Geologist	1		1	1	1	1	1	1	1	1	1	1	1
Sample Geo	1			1	1	1	1	1	1	1	1	1	1
Surveyor	1	1	1	1	1	1	1	1	1	1	1	1	1
Surveyor Assistant	1		1	1	1	1	1	1	1	1	1	1	1
Environmental Coordinator	1	1	1	1	1	1	1	1	1	1	1	1	1
Mining													
Mine Manager	1	1	1	1	1	1	1	1	1	1	1	1	1
Mine Superintendent	1	1	1	1	1	1	1	1	1	1	1	1	1
Shifter	4	4	4	4	4	4	4	4	4	4	4	4	4
Miner 1	16	8	8	12	12	16	16	16	16	16	16	16	16
Miner 2	20	8	8	12	12	20	20	20	20	20	20	20	20
Miner 3	20	8	8	12	12	20	20	20	20	20	20	20	20
Trammer	4	4	4	4	4	4	4	4	4	4	4	4	4
Swamper	4	4	4	4	4	4	4	4	4	4	4	4	4
Hoistman	4					4	4	4	4	4	4	4	4
Skip Tender	4												4
Bull Gang	6	6	6	6	6	6	6	6	6	6	6	6	6
Mill													
Mill Superintendent	1	1	1	1	1	1	1	1	1	1	1	1	1
Shift Supervisor	4	1	1	1	1	1	1	2	3	4	4	4	4
Control Room Tech	4							1	2	3	4	4	4
Rod Mill Tech	4							1	2	3	4	4	4
Float Tech	4							1	2	3	4	4	4
Thickener and Filtering Tech	4							1	2	3	4	4	4
Tailings Operator Tech	4							1	2	3	4	4	4
Maintenance													
Maintenance Manager	1	1	1	1	1	1	1	1	1	1	1	1	1
Lead Mechanic	1	1	1	1	1	1	1	1	1	1	1	1	1
Mechanic	4	2	2	4	4	4	4	4	4	4	4	4	4
Drill Doc	2	1	1	1	1	2	2	2	2	2	2	2	2
Lead Electrician	1	1	1	1	1	1	1	1	1	1	1	1	1
Electricians	4	2	2	4	4	4	4	4	4	4	4	4	4
Carpenter	1			1	1	1	1	1	1	1	1	1	1
Laborer/Custodian	2	1	1	2	2	2	2	2	2	2	2	2	2
Warehouse													
Purchasing Agent	1	1	1	1	1	1	1	1	1	1	1	1	1
Warehouse Manager	1	1	1	1	1	1	1	1	1	1	1	1	1
Buyer	1	1	1	1	1	1	1	1	1	1	1	1	1
Warehouse Tech	6	2	4	6	6	6	6	6	6	6	6	6	6
Total G&A Labor	150	71	77	98	98	123	128	134	140	146	146	146	150

Source: OSMI, 2021

Human Resource Recruiting

The recruiting process will consist of the following steps:

- Job posting
- Resume/Application screening and selection
- Pre-interview phone screening
- In person interview
- Conduct ATF and background check
- Offer letter

Human Resource Onboarding

The onboarding process will consist of the following steps:

- Pre-employment physical
- HR orientation
 - Health, Dental, Vision, Cobra, and 401K Benefits, Policies and Procedures

Safety and Environmental Training

The following training programs are required for all employees in varying degrees depending on the specific position:

- MSHA – 32 hours of training is required for initial certification
- MSHA – 8-hour site specific training
- MSHA – 8-hour annual refresher
- Environmental training – job specific training

Job Specific Training

Each position requires specific training which is dependent on the previous experience and training of the new employee. The training modules for Job Specific Depending on the previous experience and/or demonstrated knowledge of the employee some of the training modules may be exempted based on the employee's successful completion of the Training Module Assessment. An example of critical training is included for the stope miners.

Mine Stope Training

OSMI recognizes that most narrow vein journeyman miners will have transferable skills from the rubber tired mechanized mines and shaft mines to work in a conventional (rail and shaft) mine.

However, resue is a stoping method that is not commonly used and as such even seasoned miners will need be taught in order to meet productivity estimates and reduce dilution within the stope cycle.

To facilitate this training, OSMI will implement a Stope School program where the resue stope cycle will be taught to the miners. The 561 Test Stope is a miniature replication of a resue stope constructed of two manways, a service raises and two muck chutes. Located in the Monongahela Drift. The 561 Test Stope will be the Stope School where miners will learn to follow narrow veins; split-shoot ore from waste; and timber raises, manways and chutes.

A miner will remain in Stope School until they have successfully completed one complete cycle across the entire stope meeting the required benchmarks. Included in one cycle is the drilling of the ore and waste sections, loading and blasting the ore, slushing the ore to a muck pass, cribbing the manways

and chutes, then blasting the waste section. It is estimated that miners will take 3-5 weeks to complete the training properly and a miner will not graduate from the school until he has proved proficient in the entire process.

Figure 24-2 shows the key aspects of the training.

Location:	Major Learning Objectives:	Description:
Classroom	Proper Layout of Stope	General discription of equipment and utility layout within the stope
	Resue Stoping Overview	<p style="text-align: center;">Overview of Resue Mining Method and Equipment Used</p> Drilling Loading/Blasting Ore Slushing Timbering Loading/Blasting Waste
	Geology Overview	<p style="text-align: center;">Vein Structure and profile</p> Rock types Knowledge of relative rock strengths
In-Stope	Drilling	<p style="text-align: center;">Drilling Pattern</p> Collar Spacing (Dependant on Vein) Proper steel angle Knowledge/ability to read drill cuttings
	Conveyor Belt/Utilities	Proper positioning to catch optimal amount of ore Installation/connecting conveyor belt Timber slide and tugger use Advancing compressed air and water lines
	Slushing	<p style="text-align: center;">Knowledge of Equipment and Operation Method</p> Daily Equipment Maintenance and Inspection <p style="text-align: center;">Equipment Operation</p> Securing (Anchoring Slusher) using I-Pins and Chain Proper slushing techniques <p style="text-align: center;">Slusher Movement</p> How to move slusher throughout stope efficiently and safely
	Cribbed Chute Construction	Working In Proximity to Open Holes Proper tie off points Fall Protection <p style="text-align: center;">Proper Timber Installation</p> Chute alignment with dip of hanging wall Maintaining proper chute dimensions
	Loading	<p style="text-align: center;">Understanding of Process</p> Primary Explosive: Blasting Caps Secondary Explosive: Booster Tertiary Explosive: Anfo, Stick Powder, etc. <p style="text-align: center;">Timing</p> Knowledge of cap placement within the round <p style="text-align: center;">Loading Procedure (Powder Usage)</p> Placement of blasting cap and booster (in-hole) Loading of Anfo/Stick Powder (proper powder usage and fill) Installation of Hole Caps (Birdies) Clipping in and tying in Fuse Cap

Source: OSMI 2017

Figure 24-2: Stope School Objective Outline

Attraction and Retention of Employees

OSMI intends to use recruiters for senior level management employees. Hourly employees will be attracted by placing ads in local papers, on web sites, and by sending staff to locations that are known

to contain people with mining skills. These locations include the states of Arizona, New Mexico, Utah, Wyoming, California, Nevada, Idaho and Alaska. Other employee attraction methods include the use of InfoMine where job openings can be listed. InfoMine is a premier job recruiting tool that is widely used in the industry.

Retention of employees is one of the most important aspects for OSMI. Employees will be treated with respect and dignity at all levels. Personnel act with integrity, work ethically and live by these values.

OSMI provides personal development opportunities, competitive benefits, and a bonus system linked to company and personal performance. Each employee will understand how their role adds value to the company and to feel valued with a career path that offers advancement in position and pay. This is done through establishing a culture of active caring, open door policies, and conducting annual employee reviews. Where applicable, the company will support individuals career goals by providing training and mentoring to help the employee succeed. Employees that are identified as having high potential will be placed in a career path that provides training and opportunities to further their career. This is OSMI's overall succession plan to develop the leaders needed for the future.

25 Interpretation and Conclusions

25.1 Property Description and Ownership

SRK have reviewed the current licenses in relation to the geological model and Mineral Resource/Reserve, which SRK considers sufficient to cover the current estimated Mineral Resources/Reserve.

25.2 Geology and Mineralization

SRK consider the currently geological model to be reasonably well understood.

Historical mining supports the potential for economic extraction. OSMI have completed sufficient geological work, both from historical logs and via underground mapping to have provide detail input into the current geological model.

Review of the production data indicates that local variations from the current model are expected but that these changes would not be material.

25.3 Status of Exploration, Development and Operations

In comparison to the previous Mineral Resource Estimate (April 2014), the Company has completed an additional 42 diamond core holes from underground within the northern portion of the Virginius Vein, as well as completed approximately 30 channel samples.

Drilling and channel sampling completed by OSMI during 2016 has been logged and sampled by senior OSMI geological staff. All samples have been submitted to Skyline labs for preparation and analysis using both fire assay and ICP methods. OSMI has included a QA/QC program as part of the 2016 drilling campaign. While the dataset is limited in terms of population size, SRK considers the results to be within a reasonable level of error, and therefore acceptable for use in the Mineral Resource estimate.

OSMI has also completed a validation study of the historical database, which included translating the historical descriptive drilling logs into a series of logging codes in the current database. The validation work has been extended to both diamond drilling and underground channel sampling.

SRK comments that the drilling below the 2000 level conducted by prior owners was conducted using AQ sized core which was the standard practice at that time. This may not be considered best practice under guidelines today. These areas are currently not accessible, but once open follow-up drilling to validate existing results should be completed.

OSMI restarted development in June of 2020 with the work on the #2 Alimak Raise.

25.4 Mineral Processing and Metallurgical Testing

A representative sub-sample of the Master composite was examined by XRD and automated mineral analysis (AMA) for mineralogy, locking/liberation analyses and trace mineral detection. Lead was found to occur as galena, zinc was found to occur as sphalerite and copper was found to occur primarily as chalcopyrite and tetrahedrite. Tetrahedrite and polybasite were identified as the primary silver-bearing minerals in the Master composite with tetrahedrite accounting for about 75% the silver and polybasite accounting for about 25% of the silver.

RWi and BWi determinations were made on each of the variability composites and the master composites. The RWi determinations were conducted with a closing screen of 1,180 µm and resulted in RWi determinations that ranged from 11.7 to 14.0 kWh/st for the variability composites and 12.9 kWh/st for the master composite. The BWi determinations were conducted with a 180 µm closing screen and ranged from 13.7 to 16.2 kWh/st for the variability composites and 15.6 kWh/st for the master composite. It is noted that these determinations are slightly lower than what was reported for the test composites used in the PFS.

A primary grind size of P_{80} 130 µm was established as the target grind size. Re grind testwork demonstrated that regrinding of the lead rougher concentrate prior to cleaner flotation was not required.

Locked cycle testwork on the master composite demonstrated that that 94.7% of the lead, 94.8% of the silver, 91.4% of the copper and 74.2% of the gold were recovered into a lead cleaner concentrate that contained 70.3% Pb, 286 oz/st Ag, 3.07% Cu and 0.41 oz/st Au. Zinc flotation resulted in the recovery of 72.9% of the zinc, 1.3% of the silver and 2.0% of the gold into a zinc cleaner concentrate that contained 57.5% Zn, 16 oz/st Ag and 0.048 oz/st Au.

A linear regression of metal recovery versus ore grade was performed for relevant locked-cycle and large-batch tests conducted during both the FS and PFS metallurgical programs and resulted in the following observations regarding metal recovery:

- Silver recoveries achieved during the FS metallurgical program were similar to the PFS with recoveries into the lead concentrate ranging from 93% to 95% depending on feed grade
- Gold recovery into the lead concentrate ranges from 58% to 68% with an additional 4% to 6% recovery into the zinc concentrate depending upon feed grade
- Lead recovery into the lead concentrate is very consistent at 94% to 95% and relatively independent of feed grade
- Copper recovery into the lead concentrate ranges from 84% to 91% depending upon feed grade
- Zinc recovery into the zinc concentrate is estimated at 60% to 86% depending upon feed grade

Multi-element analyses were conducted on the final lead and zinc concentrates produced from Locked-cycle tests on the master composite. Significant quantities of arsenic and antimony were found in the lead concentrate.

Due to limited access in the mine, the test composites were generated from localized areas that may or may not be representative of mineralization in other areas of the mine. As such, the projected metallurgical performance could be different from that reported for this metallurgical program if significant variability in ore mineralization is encountered during mining.

25.5 Mineral Resource Estimate

SRK has undertaken geological modelling to construct updated mineralization wireframes for the Virginius Vein system, Terrible Vein and the Yellow Rose Vein systems. SRK used the 3D solids created in Leapfrog to code the drillholes to differentiate between mineralization and waste and undertook statistical and geostatistical analyses on the composited data, as constrained by the modelled wireframes. SRK reviewed the sampling information collected since the last 2017 model and noted the following in relation to the samples.

- There is a lack of independent QA/QC included in the current sampling protocols
- The production sampling has been used to compare the performance of the 2017 model but has not been used in the current estimates.
- Exploration drilling has been focused on the Blue Grass license to the northwest of the current operation, with initial intersections confirming the presence of the vein. No mineral resources have yet been defined in this area, and further exploration including a structural review should be completed to improve the geological model in this area.
- Based on this analysis SRK has elected to use the 2017 database and geological model for the basis of the current estimates, with a revised NSR (based on the latest assumptions), and depletions accounted for.

The Virginius Vein mineralization is typically associated with a dike unit and historically was coded as three separate vein codes. The revised interpretation simplifies the interpretation a single grade bearing structure. As a single structure has therefore been modelled and there remains opportunity that additional mineralization may exist to limited degrees where parallel structures are mineralized. It is SRK's opinion, this tonnage would have limited lateral and vertical extent, but good geological mapping and grade control sampling will improve the knowledge of continuity in these structures or minor splays of the main vein.

SRK has produced grade estimates using an Inverse Distance (squared) algorithm, using a combined drilling and channel sampling database. To reduce the potential impact of localized high grades overly influencing the estimates, SRK has declustered the channel samples to 50ftx50ftx50ft panels prior to estimation.

The classification is based on standards as defined by the CIM Definition Standards - For Mineral Resources and Mineral Reserves, prepared by the CIM Standing Committee on Reserve Definitions and adopted by CIM Council on May 14, 2014.

The Resources at the Project have been classified as Measured, Indicated and Inferred at Yellow Rose and Virginius Veins. The Terrible Vein has been limited to Indicated and Inferred, whereby Indicated material is focused on diamond drilling completed by previous owners from surface. The current proposed mining method for the Project will result in all material within an established stope being mined, and therefore the direct application of a CoG on a block-by-block basis is not considered appropriate for the Project. SRK has accounted for the CoG during the classification of Indicated material, by working with OSMI staff on potential mining areas. Once an area has been identified SRK has analyzed the blocks based on the confidence criteria laid out in Section 14.9, and coding the model with the NSR value. Each area has then been evaluated to ensure the defined areas remain above the NSR CoG.

25.6 Mining and Mineral Reserves

SRK has conducted a geotechnical evaluation of the Project. The characterization programs consisted of logging of 1,274 ft of core from drillholes located on the 2,000 ft level, drift face mapping from 30 stations in existing access drifts, laboratory strength testing of 38 historic and 20 new core samples. The new samples were tested by Agapito Associates in Grand Junction, Colorado. Because only a limited number of tests have been conducted to date, SRK has used the 33-percentile values for design

purposes. Confidence in the assumed rock mass characterization values used in the feasibility design comes from observations of ground conditions in the accessible historic workings.

The stable open stope dimensions were estimated. The size of open stope areas is 6 ft drift plus 6 ft resue slot with up to 6 ft wide vein and up to 1,000 ft long along vein strike. Stability estimates were also made for shrinkage stopes. Based on historic experience at the mine shrinkage stopes should remain stable if the stopes remain full of broken muck. Ground support requirements were estimated using empirical support charts which are considered adequate for feasibility-level design.

An NSR approach was used and takes into account revenue for four elements (Zn, Pb, Ag and Au) and production of two concentrates (lead concentrate and zinc concentrate). Planned mining areas were evaluated on a value basis to ensure they were economic.

The design assumes mining of large panels where raises/infrastructure are used for the entire panel length. Panel dimensions are approximately 500 to 1,000 ft along strike and up to 300 ft in height. Typically, an off-ore access drift is developed on the footwall along the length of the stope. Cribbed manways, service raises, and ore passes are located within the panels and allow multiple accesses and multiple faces within a panel.

Based on the NSR of the blocks in the resource model, large mining panels/stopes are manually identified in long section. A 3D design of the development required to mine the stopes was completed. Rehabilitation of existing workings is used when practical.

A monthly production schedule was generated using Excel for each development and stope item. This schedule was created by OSMI and SRK converted the line items and dates into an iGantt schedule to visually verify the scheduling order and tonnages/grades by period. The schedule targeted approximately 8,000 st ore/month (96,000 st/y).

25.7 Recovery Methods

The recovery methods from the process flow sheet were reviewed to determine the applicability for the process to meet the production goals determined by testing and previous studies. The review of the recovery methods did not evaluate additional testing, testing methods, or procedures to further optimize the process beyond the FS study. The evaluation and investigation did identify areas of risk that could impact plant production.

Important observations made in regard to the detailed design of the process include:

- The processing plant has limited area inside the mine for the equipment to be arranged, specifically in the underground facility. Process area and space limitations restricted the ability to place equipment in optimum configuration, and also limited equipment to what could fit in the footprint available
- OSMI has already purchased some equipment which they intended to be incorporated into the flowsheet and process, including the rod mill and the wet screen. These are further discussed in the risk section that follows

The key risks include:

- The rod mill particle feed size is at the maximum critical size. The assumed size is 0.875 in. While we believe that the rod mill lab scale data shows the process to be feasible, the full-scale equipment performance will need to be proven during startup. An increase in ore hardness could affect the throughput.

- The screen used for the closed circuit of the ball mill is not the most optimum technology available for proper size separation. A stack sizer is usually used in this situation, but the physical space available in the underground processing area did not allow for this equipment to be used. To address this issue, the water control to the screen will need to be optimized during startup and operation. It is possible that this will create situations where the size separation is not achieved, and this could reduce plant throughput.
- Process plant commissioning identified significant material handling issues throughout the concentrator that have limited production throughput and achievement of steady-state operation. Although recommendations for operational improvement have been made, there is a risk that the observed material handling issues will not be fully resolved
- Key process design parameters were significantly modified during commissioning, which resulted in significant underperformance of the concentrator.
- There is little ability to monitor concentrator performance due to the current status of the analytical or metallurgical laboratory on-site.

25.8 Project Infrastructure

The project infrastructure has been installed and is functional. There are some risks related to the infrastructure which include:

- Weather related issues including access and avalanche impact
- Power reliability that has been addressed by adding backup generation capacity
- Access to the emergency hoist at the surface for maintenance and upkeep has been addressed by changing the type of system and allowing access through the mine versus the access by mountain road to the previous system
- Water quality issues that have been addressed by the addition of water treatment facilities
- The access road is narrow and steep and winter conditions can impact access at times. The Project includes a budget for avalanche mitigation measures, developed a site access protocol and a snow removal contract. Procedures are developed and in place to address these risks.

SRK has designed the filtered tailings piles within the existing permit boundaries to a height that can store the required storage capacity. The tailings have been tested for shear strengths and those values have been used in stability analyses to demonstrate that the FOS is greater than the minimum 1.3 criteria. Tailings will be placed on the Revenue pile (eastern pile) during the summer months from May through November and on the Atlas pile (western pile) during the winter months from December through April due to avalanche precautions.

The Project has an existing permitted filtered tailings pile. A Tailings and Waste Management Plan of operations conducted by Lewicki (2015) and has been submitted for the TSF permit. Geotechnical laboratory testing has been conducted on filtered tailings and estimated material properties have been used to compute stability of the tailings stack which have a FOS greater than the minimum 1.3 criteria demonstrating that the feasibility design is adequate.

A permit revision in the future will be required to modify the permitted 8.9 Mft³ storage capacity after about 5 years of continuous production because more than 8.9 Mft³ tailings will be produced thereafter. Since the revision is in the same footprint as the current TSF it does not impact the current permit boundary or disturbed area and therefore will be a Technical Revision which does not require public

notice. SRK currently sees no reasonable objection because such Technical Revision would not be granted.

Even with the best engineering, it is likely that some of the pumps will not operate correctly for the process. Most of this can be fixed by changing out sheaves and belts. However, in rare cases the entire pump may need to be changed. If this problem occurs the startup schedule can be slightly delayed.

25.9 Environmental Studies and Permitting

As an underground mine, the Project creates a limited surface footprint of disturbance. The geochemistry of the waste rock and tailings indicate benign leachate chemistry and low potential for environmental degradation. Over the mine's 140-year history, including the surface stockpiles of development waste rock, there is no evidence of acid rock drainage at the site.

Correspondence between OSMI and regulatory authorities indicate productive and effective communication in terms of existing permits and amendments. As of the date of this report, SRK is of the opinion it is reasonable to expect OSMI to maintain the necessary environmental permits to re-start operations at the Project.

25.10 Capital and Operating Costs

Capital and operating costs have been estimated at a level appropriate for a FS. Overall accuracy is estimated at +/- 15% for both capital and operating costs.

The remaining capital items have been developed and costs estimated in the previous phase of work and will be self-performed in most cases.

Operating costs have been updated with the recent wage rates and required wage levels to obtain and retain quality personnel. Operating costs include updated productivity information from the mine preproduction efforts. The majority of costs are developed on a first principles basis and from OSMI's recent experience operating in the region. Notably, the operating cost estimate includes corporate overhead as well as Project costs.

25.11 Economic Analysis

The economic model for the Project demonstrates that under the current set of economic assumptions, the Project provides a robust positive cash flow over the LoM. The Project benefits from existing development and equipment which provides for lower initial capital than a greenfield development project. Gold, copper, lead and zinc byproduct credits provide an opportunity for a low production cost for silver on a byproduct or silver equivalent basis.

Extracting maximum value from the concentrates, including receiving precious metal credits for the zinc concentrate, which wasn't contemplated in this report, will provide significant benefit to the Project, including upside opportunity relative to the included economic model. Therefore, SRK recommends optimizing the sales strategy for concentrates will be important to maximizing Project value.

26 Recommendations

26.1 Mineral Resources

To extend mine life, SRK considers there to be requirement to conduct further drilling to increase the confidence in the structure at the Virginius and Terrible Veins in material currently defined as Inferred. To increase the confidence in the Inferred estimates OSMI will be required to:

- Review and modification of the underground production sampling protocols to ensure continuous sampling is completed, following industry best practices, including the submission of an independent QA/QC program.
- Monitor the QA/QC program as an ongoing process.
- Continue infill and step out drilling to explore the vein systems along strike and down dip.
 - Infill above the 1800 level between the two areas currently defined as Indicated, should be considered the priority.
 - Additional drilling will be required to increase confidence in the Virginius estimates below the 2210 level within the Monongahela area, prior to mining.
- Institute a regular practice of downhole surveys for drilling, at intervals as appropriate.
- In exploration discontinue the use of pulp blanks and incorporate preparation blanks into the QA/QC program.
- SRK consider best practice to add check assays at the end of any exploration program or on a routine basis to the QA/QC program. Check assays are second analysis by a second laboratory of the original pulp submitted to the primary laboratory, these check analysis could also be completed on the sample pulps from the 2021 sampling programs to increase the confidence in the assay values.
- Routine mapping and sampling of any future development heads is required, with a detail procedure documented to ensure sampling quality.

SRK considers the current estimate could be improved by the following studies:

- Development of a mine scale structural and geological model. This could assist in guiding future exploration at depth within the conglomerates, as well as identifying and areas of risk for changes in ground conditions.
- The current density database should be increase with the inclusion of routine density measurements taken on all new drilling and from underground; and
- Development of a short-term model using underground sampling data which can be used to compare future short-term variations to the long-term Mineral Resource estimates.

26.2 Mining Methods

As new mining areas are opened up it is recommended that additional rock mass characterization data be collected in area where data is not currently available. This data should be used to assess the level of ground support required to maintain short-term or long-term stability, as appropriate. This is envisioned as an ongoing activity that is part of routine mine development.

The following recommendations are for additional work during the pre-production and early operations:

- Continue to develop and improve the “Mine Stope Training” effort for resale mining. The actual execution of the miners in the stope is key to achieving the production parameters defined in the mine plan
- Continue to monitor and develop the resale mining dilution and swell characteristics to optimize resale mining waste volume balance and minimize dilution
- Further optimize the potential upside associated with “leaving as waste” certain low-grade areas of the currently defined stope areas
- Maintain ductwork to optimize effectiveness of ventilation especially in the rigid duct required for Shaft #1
- Examine the fire risks and potential mitigating factors that can be implemented. A detailed fire analysis was not conducted as a part of this study. OSMI can conduct this with in house personnel or use outside sources

26.3 Recovery Methods

The following recommendations are made by Barr based on their experience with rod/ball mill circuits depending upon the results of initial operations, should issues arise:

- Evaluate media size for the rod mill, as different rod sizes could improve grinding efficiency (depending on feed size to the rod mill)
- Evaluate the opportunity to prescreen rod mill feed to bypass the fines to the 2nd stage of grinding to increase capacity of the rod mill

The following recommendations are made by SRK based on their December 2021 site visit during plant commissioning:

- OSMI should hire an experienced metallurgical engineer to provide technical and operational oversight of the concentrator.
- The deficiencies that have been identified in the concentrator should be corrected and the plant should be commissioned with demonstration that process design parameters can be fully achieved prior to initiation of commercial production. As part of this effort, the recommendations presented in Section 17-7 of this report should be implemented.

26.4 Project Infrastructure

The primary risks to the Project related to infrastructure include:

- Weather related issues including access and avalanche impact
- Power reliability that has been addressed by adding backup generation capacity
- Access to the emergency hoist at the surface for maintenance and upkeep has been addressed by changing the type of system and allowing access through the mine versus the access by mountain road to the previous system
- Water quality issues that have been addressed by the addition of water treatment facilities
- The access road is narrow and steep and winter conditions can impact access at times. The Project includes a budget for avalanche mitigation measures and a snow removal contract. Procedures are developed and in place to address these risks

The major infrastructure related items have been addressed. SRK makes no additional recommendations for additional work.

SRK has designed the filtered tailings piles within the existing permit boundaries to a height that can store the required storage capacity. The tailings have been tested for shear strengths and those values have been used in stability analyses to demonstrate that the FOS is greater than the minimum 1.3 criteria. As the pile is developed over time, it is recommended that periodic in situ compacted density and shear strength checks be made to ensure the design is performing as intended. Also, checks of water levels within the pile should be monitored to ensure that the pile remains drained.

26.5 Environmental Studies and Permitting

Given this Project is a re-start of an existing underground mine and that the previous mining activity was relatively recent and in accordance with environmental permits that remain active, SRK makes no further recommendations related to environmental studies or permits.

26.6 Recommended Work Program Costs

Table 26-1 summarizes the costs for recommended work programs.

Table 26-1: Summary of Costs for Recommended Work

Discipline	Program Description	Cost (US\$)	Reason Why No Further Work is Recommended:
Geology and Mineralization	Ongoing mapping and drilling		This program is included in the Project budget
Mineral Processing and Metallurgical Testing	None Identified		FS metallurgical program complete
Mineral Resource Estimate	Ongoing mapping and drilling		This program is included in the Project budget
Mineral Reserves	Fire Prevention Program for specific large equipment including hoist, rod mill, ball mill, etc.	\$15,000	
Mining Methods	Miner Training Program		Identified issue addressed within the Project budget
Recovery Methods	Rod mill optimization - Rod size changes no additional cost, potential additional screen or mill modifications are longer term options not needed during re-start		No additional cost for rod mill optimization. Rod mill pre-screening recommendation addresses potential capacity increases in the future if needed and presents no additional cost to plant reactivation
Total US\$		\$15,000	

27 References

- ALS Geochemistry (2013). Schedule of Services and Fees, 2013 USD.
- Benham, J. L. (1980). Camp Bird and the Revenue: Bear Creek Publishing Company, Ouray, Colorado, 68p.
- Burbank, W. S. (1941). Structural Control of Ore Deposition in the Red Mountain, Sneffels, and Telluride Districts of the San Juan Mountains, Colorado: Colorado Scientific Society Proceedings, V. 14, No. 5, p. 141-261.
- Burbank, W. S. and Luedke, R. G. (1969). Geology and Ore Deposits of the Eureka and Adjoining Districts, San Juan Mountains, Colorado: U. S. G. S. Pro. Pap. 535, 73 p.
- Burbank, W. S. and Luedke, R. G. (1968). Geology and Ore Deposits of the Western San Juan Mountains, Colorado; in Ridge, J. D., Ed., Ore Deposits of the United States, 1933-1967, (Graton – Sales Vol.): New York, American Institute of Mining, Metallurgical and Petroleum Engineers, p. 714-733.
- Burbank, W. S. and Luedke, R. G. (1966). Geologic Map of the Telluride Quadrangle, Southwestern Colorado: U.S.G.S. Geologic Quadrangle Map GQ-504.
- Burbank, W. S. and Luedke, R. G. (1964). Geology of the Iron-ton Quadrangle, Colorado: U.S.G.S. Geologic Quadrangle Map GQ-291.
- Casadevall, T. and Ohmoto, H. (1977). Sunnyside Mine, Eureka Mining District, San Juan County, Colorado, Geochemistry of gold and base metal ore formation in the volcanic environment, Economic Geology, v. 72, p. 1285-1320.
- CH2M Hill (2012). Site Conditions Report Rev. C, August 30, 2012.
- CIM (2014). Canadian Institute of Mining, Metallurgy and Petroleum Definition Standards for Mineral Resources and Mineral Reserves, adopted by the CIM Council on May 10, 2014.
- Clark, L. (1998). Minimizing Dilution in Open Stope Mining with a Focus on Stope Design and Narrow Vein Longhole Blasting. M.Sc. thesis, Department of Mining and Mineral Process Engineering, The University of British Columbia, 316 p.
- Coxe, B. W. (1985). The Virginus Vein Ore Deposit, Northwestern San Juan Mountains, Colorado: A Study of the Mineralogy, Structure and Fluid Inclusions of an Epithermal Base Metal and Silver Vein in a Volcanic Environment: M.S. Thesis, University of New Mexico, 126 p.
- Dawson Metallurgical Laboratories, Inc. (1998). Results of Continued Flotation Tests and an Amalgamation Test Performed on Whole Ore from the Revenue Virginia Project, June 29, 1998.
- Dawson Metallurgical Laboratories, Inc., (1994). Results of Flotation Test Work on a Silver Bearing Tetrahedrite – Galena Ore from the Revenue Virginus Property, February 23, 1994.
- Fairplay Minerals Inc. (2016). Strategic Mine Plan & Economics for Ouray Silver Mines, PowerPoint Presentation, January 8, 2016.

- FLSmidth, (2017). Revenue Mine Project-Thickening and Filtration Testing, prepared for Ouray Silver Mines, Inc., by FLSmidth Minerals Testing and Research Center, Braun, Jennifer, Salt Lake City, Utah, April 19, 2017.
- FLSmidth, (2017) Dawson Metallurgical Labs – Locked cycle flotation tests for OSMI ore, Excel spreadsheet test data results. Received Clint Fletcher OSMI email April 17, 2017.
- FLSmidth, (2016). Metallurgical Testing Program on the Revenue Mine Project, prepared for SRK Consulting, by FLSmidth Minerals Testing and Research Center, Kallen Konen, Perry Allen, Paul Bennett, Salt Lake City, Utah, July 22, 2016.
- FLSmidth (2016). Mineralogical Characterization of Composite Samples from Ouray Revenue Mine and Flotation Concentrates from FLSmidth Locked-Cycle Testing, June 14, 2016.
- FLSmidth (2016). Bond Crusher and Rod Mill Work Indexes, Dawson Metallurgical Laboratories, March 2016.
- Garrey, G. H. (1949). Outline of Future Ore Possibilities in The Revenue Groups of Mines Near Ouray, Colorado, Internal Company Report, 6p.
- Garrey, G. H. (1947). Progress Report on the Properties of the Revenue Development Corporation, Ouray, Colorado, Internal Company Report, 16p.
- Hartman, Howard L. et al, 1997, Mine Ventilation and Air Conditioning, Third Edition, John Wiley and Sons, Inc., 730 pp.
- Lewicki, G. (2015). Revenue Mill Certification, Revenue Mine, Ouray Silver Mines, Inc. DRMS ID M-2012-032, November 2015.
- Lipman, P.W.; Fisher, F.S.; Mehnert, H.; Naeser, C.W.; Luedke, R.G. & Steven, T.A. (1976). Multiple Ages of mid-Tertiary Mineralization and Alteration in the Western San Juan Mountains, Colorado: Economic Geology, V. 71, p. 571-588.
- Lipman, P.W.; Steven, T.A.; Luedke, R.G.; & Burbank, W.S. (1973). Revised volcanic history of the San Juan, Uncompahgre, Silverton and Lake City calderas in the western San Juan Mountains, Colorado, U. S. G. S. Journal Research, v. 1, no. 6 p. 627-642.
- Luedke, R.G. & Burbank, W.S. (1962). Geology of the Ouray quadrangle, Colorado: U.S.G.S. Geologic Quadrangle Map GQ-152.
- Lycopodium, (2016). Process Plant Upgrade Pre-Feasibility Study, prepared for Ouray Silver Mines, Inc., by Lycopodium Minerals Canada Ltd., June 2016, Revision 0.
- Mayor, J.N. (1971). Ore Reserves, definition of categories and calculation, Internal Memorandum Dated, March 4, 1971, Unpublished, 3 p.
- McPherson, M.J., 2009, Subsurface Ventilation Engineering, Published by Mine Ventilation Services, Inc., 824 pp.
- Nowicki, K. (2016) Thickening, Rheology and Pressure Filtration Testing, FLSmidth Laboratory Test Report, May 2016.
- OSMI, (2016). OSMI Design Criteria BKB 27Dec16, prepared for OSMI, by Ouray Silver Mines, Inc., December 27, 2016.
- OSMI (2016). Total Mining Methods, Head Grades Excel Spreadsheet from OSMI, February 26, 2016.

- Perry, R. (2013). Internal Star research related to historic mining and geology including background material in support of project reporting.
- Potvin, Y. (2001). Empirical open stope design in Canada. PhD. Thesis, Dept. Mining and Mineral Processing, University of British Columbia.
- SRK, (2016). Prefeasibility Study Report, prepared for Ouray Silver Mines, Inc., by SRK Consulting (U.S.), Inc., Clarke et al., August 3, 2016
- SRK (2016). Reagents Dosages for Processing Virginius Main Ore, Excel Spreadsheet from SRK Consulting, May 31, 2016.
- SRK (2016) OSMI – Summary of VM Comp Grind Series and NaCN Series Rougher Tests Using T#2 Float Scheme, Excel Spreadsheet from SRK Consulting, April 13, 2016.
- SRK (2016). Technical Evaluation, Gap Analysis and Risk Summary Report, SRK Consulting, January 25, 2016.
- SRK (2015) Metallurgical Review Technical Memorandum, SRK Consulting, December 28, 2015.
- SRK (2014). NI 43-101 Technical Report, Preliminary Economic Assessment, The Revenue Mine, Sneffels, Colorado. Unpublished report for Fortune Minerals Ltd., effective date April 18, 2014, report date July 23, 2014.
- SRK (2012). Resource Report on Revenue_Virginius and Yellow Rose Mines Sneffels, Colorado, unpublished report for: Silver Star Resources LLC, 51 p.
- Steven, T.A. & Lipman, P.W. (1976). Calderas of the San Juan Volcanic Field, Southwestern Colorado: U. S. G. S. Pro. Pap. 958, 35 p.
- Sunshine Mining & Refining Company (2001). Information Memorandum dated January 12, 2001.
- Sunshine Mining & Refining Company (2000). www.infomine.com, accessed December 2011; www.intierra.com accessed June 2012.
- Thompson CTL (2015). Laboratory Test Results-Mill Tailings Report to Fortune Revenue Silver Mines, dated July 16, 2015.
- Tremlett, C.P. (1976). Report on the Virginius Mine, Ouray, Colorado, Internal Consulting Report, 32p.
- Varnes, D.J. (1963). Geology and Ore Deposits of the South Silverton Mining Area, San Juan County, Colorado: U.S. G. S. Pro. Pap. 378 a, 56p.
- Zahony, S. (2013). Property Report, Internal report on the property prepared for Jim Williams and Rory Williams, November 2013, 19p.
- Zahony, S. (2013b). Grade Resolution for Ranchers 210-F-9 Stope – Probable Mining Grade, Memo to Jim Williams and Rory Williams, November 15, 2013.

28 Glossary

The Mineral Resources and Mineral Reserves have been classified according to CIM (CIM, 2014). Accordingly, the Resources have been classified as Measured, Indicated or Inferred, the Reserves have been classified as Proven and Probable based on the Measured and Indicated Resources as defined below.

28.1 Mineral Resources

A **Mineral Resource** is a concentration or occurrence of solid material of economic interest in or on the Earth's crust in such form, grade or quality and quantity that there are reasonable prospects for eventual economic extraction. The location, quantity, grade or quality, continuity and other geological characteristics of a Mineral Resource are known, estimated or interpreted from specific geological evidence and knowledge, including sampling.

An **Inferred Mineral Resource** is that part of a Mineral Resource for which quantity and grade or quality are estimated on the basis of limited geological evidence and sampling. Geological evidence is sufficient to imply but not verify geological and grade or quality continuity. An Inferred Mineral Resource has a lower level of confidence than that applying to an Indicated Mineral Resource and must not be converted to a Mineral Reserve. It is reasonably expected that the majority of Inferred Mineral Resources could be upgraded to Indicated Mineral Resources with continued exploration.

An **Indicated Mineral Resource** is that part of a Mineral Resource for which quantity, grade or quality, densities, shape and physical characteristics are estimated with sufficient confidence to allow the application of Modifying Factors in sufficient detail to support mine planning and evaluation of the economic viability of the deposit. Geological evidence is derived from adequately detailed and reliable exploration, sampling and testing and is sufficient to assume geological and grade or quality continuity between points of observation. An Indicated Mineral Resource has a lower level of confidence than that applying to a Measured Mineral Resource and may only be converted to a Probable Mineral Reserve.

A **Measured Mineral Resource** is that part of a Mineral Resource for which quantity, grade or quality, densities, shape, and physical characteristics are estimated with confidence sufficient to allow the application of Modifying Factors to support detailed mine planning and final evaluation of the economic viability of the deposit. Geological evidence is derived from detailed and reliable exploration, sampling and testing and is sufficient to confirm geological and grade or quality continuity between points of observation. A Measured Mineral Resource has a higher level of confidence than that applying to either an Indicated Mineral Resource or an Inferred Mineral Resource. It may be converted to a Proven Mineral Reserve or to a Probable Mineral Reserve.

28.2 Mineral Reserves

A **Mineral Reserve** is the economically mineable part of a Measured and/or Indicated Mineral Resource. It includes diluting materials and allowances for losses, which may occur when the material is mined or extracted and is defined by studies at Pre-Feasibility or Feasibility level as appropriate that include application of Modifying Factors. Such studies demonstrate that, at the time of reporting, extraction could reasonably be justified.

The reference point at which Mineral Reserves are defined, usually the point where the ore is delivered to the processing plant, must be stated. It is important that, in all situations where the reference point

is different, such as for a saleable product, a clarifying statement is included to ensure that the reader is fully informed as to what is being reported. The public disclosure of a Mineral Reserve must be demonstrated by a Pre-Feasibility Study or Feasibility Study.

A **Probable Mineral Reserve** is the economically mineable part of an Indicated, and in some circumstances, a Measured Mineral Resource. The confidence in the Modifying Factors applying to a Probable Mineral Reserve is lower than that applying to a Proven Mineral Reserve.

A **Proven Mineral Reserve** is the economically mineable part of a Measured Mineral Resource. A Proven Mineral Reserve implies a high degree of confidence in the Modifying Factors.

28.3 Definition of Terms

The following general mining terms may be used in this report.

Table 28-1: Definition of Terms

Term	Definition
Assay	The chemical analysis of mineral samples to determine the metal content.
Capital Expenditure	All other expenditures not classified as operating costs.
Composite	Combining more than one sample result to give an average result over a larger distance.
Concentrate	A metal-rich product resulting from a mineral enrichment process such as gravity concentration or flotation, in which most of the desired mineral has been separated from the waste material in the ore.
Crushing	Initial process of reducing ore particle size to render it more amenable for further processing.
Cut-off Grade (CoG)	The grade of mineralized rock, which determines as to whether or not it is economic to recover its gold content by further concentration.
Dilution	Waste, which is unavoidably mined with ore.
Dip	Angle of inclination of a geological feature/rock from the horizontal.
Fault	The surface of a fracture along which movement has occurred.
Footwall	The underlying side of an orebody or stope.
Gangue	Non-valuable components of the ore.
Grade	The measure of concentration of gold within mineralized rock.
Hangingwall	The overlying side of an orebody or slope.
Haulage	A horizontal underground excavation which is used to transport mined ore.
Hydrocyclone	A process whereby material is graded according to size by exploiting centrifugal forces of particulate materials.
Igneous	Primary crystalline rock formed by the solidification of magma.
Kriging	An interpolation method of assigning values from samples to blocks that minimizes the estimation error.
Level	Horizontal tunnel the primary purpose is the transportation of personnel and materials.
Lithological	Geological description pertaining to different rock types.
LoM Plans	Life-of-Mine plans.
LRP	Long Range Plan.
Material Properties	Mine properties.
Milling	A general term used to describe the process in which the ore is crushed and ground and subjected to physical or chemical treatment to extract the valuable metals to a concentrate or finished product.
Mineral/Mining Lease	A lease area for which mineral rights are held.
Mining Assets	The Material Properties and Significant Exploration Properties.
Ongoing Capital	Capital estimates of a routine nature, which is necessary for sustaining operations.
Ore Reserve	See Mineral Reserve.
Pillar	Rock left behind to help support the excavations in an underground mine.
RoM	Run-of-Mine.
Sedimentary	Pertaining to rocks formed by the accumulation of sediments, formed by the erosion of other rocks.

Term	Definition
Shaft	An opening cut downwards from the surface for transporting personnel, equipment, supplies, ore and waste.
Sill	A thin, tabular, horizontal to sub-horizontal body of igneous rock formed by the injection of magma into planar zones of weakness.
Smelting	A high temperature pyrometallurgical operation conducted in a furnace, in which the valuable metal is collected to a molten matte or doré phase and separated from the gangue components that accumulate in a less dense molten slag phase.
Stope	Underground void created by mining.
Stratigraphy	The study of stratified rocks in terms of time and space.
Strike	Direction of line formed by the intersection of strata surfaces with the horizontal plane, always perpendicular to the dip direction.
Sulfide	A sulfur bearing mineral.
Tailings	Finely ground waste rock from which valuable minerals or metals have been extracted.
Thickening	The process of concentrating solid particles in suspension.
Total Expenditure	All expenditures including those of an operating and capital nature.
Variogram	A statistical representation of the characteristics (usually grade).

28.4 Abbreviations

The following abbreviations may be used in this report.

Table 28-2: Abbreviations

Abbreviation	Unit or Term
µm	micrometer
AAS	Atomic Absorption Spectroscopy
ABA	acid-base accounting
Ag	silver
AGP	acid generating potential
Alimak Hex	Alimak style hoist/elevator system
AMA	automated mineral analysis
ANFO AP	ammonium nitrate fuel oil
ANP	acid neutralizing potential
Au	gold
Aurcana	Aurcana Silver Corporation
Barr	Barr Engineering Co.
BLM	Bureau of Land Management
BTS	Brazilian tensile strength
CDPHE	Colorado Department of Public Health and Environment
CIM	Canadian Institute of Mining, Metallurgy and Petroleum
CoG	cut-off grade
CPDS	Colorado Discharge Permit System
CRM	Certified Reference Materials
CRS	Colorado Revised Statutes
Cu	copper
Dk	dike
DRMS	Division of Reclamation, Mining and Safety
DSS	direct shear strength
EBITDA	earnings before interest, taxes, depreciation, and amortization
EPC	engineering, procurement, and construction
ERP	Enterprise Resource Planning
FA	Fire Assay
FML	Fortune Minerals Limited
FOS	factor of safety
FRSM	Fortune Revenue Silver Mines, Inc.
FS	feasibility study
ft	feet
ft ²	square foot

Abbreviation	Unit or Term
FW	footwall
G&A	general and administrative
HDPE	high-density polyethylene
HSE	Health, Safety and Environmental
HW	hangingwall
HWC	Harrison Western Construction Corporation
ID2	inverse distance squared
IP	internet protocol
IRR	internal rate of return
kcfm	thousands of cubic feet per minute
koz	thousand ounces
kst	thousand short tons
kVA	kilo volt amperes
kWh	kilowatt hour
lb/ft ³	pounds per cubic foot
lbf	pound-force
LoM	life-of-mine
LRC-FRSM	LRC-FRSM, LLC
LRC-FRSM II	LRC-FRSM II, LLC (an affiliate of LRC-FRSM)
LV	low voltage
m ³	cubic meters
MCC	motor control center
Mft ³	million cubic feet
MkW	million kilowatts
Mlb	million pounds
Moz	million ounces
MRA	Master Restructuring Agreement
MRC	Management Resource Consulting
MVA	mega volt amp
MW	million watts
NMPM	New Mexico Prime Meridian
NN	nearest neighbor
NNP	net neutralizing potential
NOEC	no observed effects concentrations
NPV	Net Present Value
NSR	Net Smelter Return
OSMI	Ouray Silver Mines, Inc.
oz/st	ounce per short ton
Pb	lead
PFS	Prefeasibility Study Report
PPE	property, plant and equipment
Project	Revenue-Virginius Mine
psi	pound-force per square inch
QA/QC	quality assurance/quality control
QP	Qualified Persons
Ranchers	Ranchers Exploration and Development Corp.
RM	Reference materials
RQD	Rock Quality Designation
SIPX	sodium isopropyl xanthate
SJ	San Juan formation
SPLP	synthetic precipitation leachate procedure
SRK	SRK Consulting (U.S.), Inc.
st/d	short ton per day
SWMP	Storm Water Management Plan
t	tonne
t/y	tonne per year
TCS	triaxial compressive strength
TDS	total dissolved solids
TR-09	Technical Revision 9
TRE	Toxicity Reduction Evaluation

Abbreviation	Unit or Term
TSF	tailings storage facility
UCS	uniaxial compressive strength
USGS	U.S. Geological Survey
VAC	Voltage alternating current
VFD	variable frequency drive
VHD	Virginius High Dilution
VHW	Virginius Hanging Wall
VoIP	voice over internet protocol
WET	whole effluent toxicity
wmt	wet metric tonnes
WQCD	Water Quality Control Division
XRD	x-ray diffraction
Zn	zinc

Appendices

Appendix A: Certificates of Qualified Persons

CERTIFICATE OF QUALIFIED PERSON

I, Joanna Poeck, BEng Mining, SME-RM, MMSAQP, do hereby certify that:

1. I am a Principal Mining Engineer of SRK Consulting (U.S.), Inc., 1125 Seventeenth Street, Suite 600, Denver, CO, USA, 80202.
2. This certificate applies to the technical report titled "NI 43-101 Technical Report, Feasibility Study, Revenue–Virginius Mine, Ouray, Colorado" with an Effective Date of December 31, 2021 (the "Technical Report").
3. I graduated with a degree in Mining Engineering from Colorado School of Mines in 2003. I am a Registered Member of the Society of Mining, Metallurgy & Exploration Geology. I am a QP member of the Mining & Metallurgical Society of America. I have worked as a Mining Engineer for a total of 18 years since my graduation from university. My relevant experience includes open pit and underground design, mine scheduling, pit optimization and truck productivity analysis.
4. I have read the definition of "qualified person" set out in National Instrument 43-101 (NI 43-101) and certify that by reason of my education, affiliation with a professional association (as defined in NI 43-101) and past relevant work experience, I fulfill the requirements to be a "qualified person" for the purposes of NI 43-101.
5. I have not visited the Revenue Mine property.
6. I am responsible for Mining Sections 15, 16.1, 16.3, 16.4 and portions of sections 1, 25 and 26.
7. I am independent of the issuer applying all of the tests in section 1.5 of NI 43-101.
8. I have had prior involvement with the property that is the subject of the Technical Report. The nature of my prior involvement is acting as QP for report titled "NI 43-101 Technical Report Feasibility Study Revenue–Virginius Mine Ouray, Colorado" dated July 30, 2018 with an effective date of June 15, 2018.
9. I have read NI 43-101 and Form 43-101F1 and the sections of the Technical Report I am responsible for have been prepared in compliance with that instrument and form.
10. As of the aforementioned Effective Date, to the best of my knowledge, information and belief, the sections of the Technical Report I am responsible for contains all scientific and technical information that is required to be disclosed to make the Technical Report not misleading.

Dated this 11th Day of March, 2022.

"Signed"

"Sealed"

Joanna Poeck, BEng Mining, SME-RM[4131289RM], MMSAQP[01387QP]
Principal Consultant (Mining Engineer)

U.S. Offices:

Anchorage	907.677.3520
Clovis	559.452.0182
Denver	303.985.1333
Elko	775.753.4151
Fort Collins	970.407.8302
Reno	775.828.6800
Tucson	520.544.3688

Canadian Offices:

Saskatoon	306.955.4778
Sudbury	705.682.3270
Toronto	416.601.1445
Vancouver	604.681.4196
Yellowknife	867.873.8670

Group Offices:

Africa
Asia
Australia
Europe
North America
South America

CERTIFICATE OF QUALIFIED PERSON

I, Terry Braun, MSc, PE do hereby certify that:

1. I am President, Practice Leader, and Principal Consultant (Civil Engineer) of SRK Consulting (U.S.), Inc., 1125 Seventeenth Street, Suite 600, Denver, CO, USA, 80202.
2. This certificate applies to the technical report titled "NI 43-101 Technical Report, Feasibility Study, Revenue–Virginius Mine, Ouray, Colorado" with an Effective Date of December 31, 2021 (the "Technical Report").
3. I graduated with a degree in Civil Engineering from University of Colorado, Boulder in 1988. In addition, I have obtained a Master of Science degree in Environmental Science and Engineering with the Colorado School of Mines in 1993. I am a Professional Engineer (Civil), registered in the State of Colorado. I have worked as an engineer for a total of 30 years since my graduation from university. My relevant experience includes various environmental permitting projects throughout the United States as well as detailed review and assessment of environmental aspects of projects outside of the U.S, including South America. I have also prepared and/or reviewed cost estimates for operations and closure of various open pit and underground facilities and associated infrastructure.
4. I have read the definition of "qualified person" set out in National Instrument 43-101 (NI 43-101) and certify that by reason of my education, affiliation with a professional association (as defined in NI 43-101) and past relevant work experience, I fulfill the requirements to be a "qualified person" for the purposes of NI 43-101.
5. I have not visited the Revenue Mine property.
6. I am responsible for Environmental Section 20 and portions of section 1, 25 and 26
7. I am independent of the issuer applying all of the tests in section 1.5 of NI 43-101.
8. I have had prior involvement with the property that is the subject of the Technical Report. The nature of my prior involvement is acting as QP on the report titled "NI 43-101 Technical Report Feasibility Study Revenue–Virginius Mine Ouray, Colorado" dated July 30, 2018 with an effective date of June 15, 2018.
9. I have read NI 43-101 and Form 43-101F1 and the sections of the Technical Report I am responsible for have been prepared in compliance with that instrument and form.
10. As of the aforementioned Effective Date, to the best of my knowledge, information and belief, the sections of the Technical Report I am responsible for contains all scientific and technical information that is required to be disclosed to make the Technical Report not misleading.

Dated this 11th Day of March, 2022.

"Signed"

"Sealed"

Terry Braun, MSc, PE [CO 28711]
President/Practice Leader/Principal Consultant (Civil Engineer)

U.S. Offices:

Anchorage	907.677.3520
Clovis	559.452.0182
Denver	303.985.1333
Elko	775.753.4151
Fort Collins	970.407.8302
Reno	775.828.6800
Tucson	520.544.3688

Canadian Offices:

Saskatoon	306.955.4778
Sudbury	705.682.3270
Toronto	416.601.1445
Vancouver	604.681.4196
Yellowknife	867.873.8670

Group Offices:

Africa
Asia
Australia
Europe
North America
South America

CERTIFICATE OF QUALIFIED PERSON

I, Eric Olin, MSc, MBA, RM-SME do hereby certify that:

1. I am a Principal Process Metallurgist of SRK Consulting (U.S.), Inc., 1125 Seventeenth Street, Suite 600, Denver, CO, USA, 80202.
2. This certificate applies to the technical report titled NI 43-101 Technical Report, Feasibility Study, Revenue–Virginus Mine, Ouray, Colorado, with an Effective Date of December 31, 2021 (the “Technical Report”).
3. I graduated with a Master of Science degree in Metallurgical Engineering from the Colorado School of Mines in 1976. I am a Registered Member of The Society for Mining, Metallurgy and Exploration, Inc. I have worked as a Metallurgist for a total of 40 years since my graduation from the Colorado School of Mines. My relevant experience includes extensive consulting, plant operations, process development, project management and research & development experience with base metals, precious metals, ferrous metals and industrial minerals. I have served as the plant superintendent for several gold and base metal mining operations. Additionally, I have been involved with numerous third-party due diligence audits, and preparation of project conceptual, pre-feasibility and full-feasibility studies.
4. I have read the definition of “qualified person” set out in National Instrument 43-101 (NI 43-101) and certify that by reason of my education, affiliation with a professional association (as defined in NI 43-101) and past relevant work experience, I fulfill the requirements to be a “qualified person” for the purposes of NI 43-101.
5. I visited the Revenue Mine property on December 15, 2021 for 1 day.
6. I am responsible for the preparation of Metallurgy Sections 13, 17, 21.1.3, 21.2.4 and portions of sections 1, 25 and 26 of the Technical Report.
7. I am independent of the issuer applying all of the tests in section 1.5 of NI 43-101.
8. I have had prior involvement with the property that is the subject of the Technical Report. The nature of my prior involvement is acting as QP on the report titled “NI 43-101 Technical Report Feasibility Study Revenue–Virginus Mine Ouray, Colorado” with a report date of July 30, 2018 and an effective date of June 15, 2018.
9. I have read NI 43-101 and Form 43-101F1 and the sections of the Technical Report I am responsible for have been prepared in compliance with that instrument and form.
10. As of the aforementioned Effective Date, to the best of my knowledge, information and belief, the sections of the Technical Report I am responsible for contains all scientific and technical information that is required to be disclosed to make the Technical Report not misleading.

Dated this 11th Day of March, 2022.

“Signed”

“Sealed”

Eric Olin, MSc, MBA, RM-SME

U.S. Offices:

Anchorage	907.677.3520
Clovis	559.452.0182
Denver	303.985.1333
Elko	775.753.4151
Fort Collins	970.407.8302
Reno	775.828.6800
Tucson	520.544.3688

Canadian Offices:

Saskatoon	306.955.4778
Sudbury	705.682.3270
Toronto	416.601.1445
Vancouver	604.681.4196
Yellowknife	867.873.8670

Group Offices:

Africa
Asia
Australia
Europe
North America
South America

CERTIFICATE OF QUALIFIED PERSON

I, Jeff Osborn, BEng Mining, MMSAQP do hereby certify that:

1. I am a Principal Consultant (Mining Engineer) of SRK Consulting (U.S.), Inc., 1125 Seventeenth, Suite 600, Denver, CO, USA, 80202.
2. This certificate applies to the technical report titled "NI 43-101 Technical Report, Feasibility Study, Revenue–Virginius Mine, Ouray, Colorado" with an Effective Date of December 31, 2021 (the "Technical Report").
3. I graduated with a Bachelor of Science Mining Engineering degree from the Colorado School of Mines in 1986. I am a Qualified Professional (QP) Member of the Mining and Metallurgical Society of America. I have worked as a Mining Engineer for a total of 34 years since my graduation from university. My relevant experience includes responsibilities in operations, maintenance, engineering, management, and construction activities.
4. I have read the definition of "qualified person" set out in National Instrument 43-101 (NI 43-101) and certify that by reason of my education, affiliation with a professional association (as defined in NI 43-101) and past relevant work experience, I fulfill the requirements to be a "qualified person" for the purposes of NI 43-101.
5. I visited the Revenue Mine property on May 16, 2014, August 24, 2015, May 5, 2016, May 15, 2017, June 15, 2018, December 15, 2021.
6. I am responsible for Sections 2, 3, 16.5, 16.6, 16.8, 18 with the exception of 18.3, 19, 21 with the exception of 21.1.3 and 21.1.4, 22, 23, and 24 and portions of sections 1, 25 and 26.
7. I am independent of the issuer applying all of the tests in section 1.5 of NI 43-101.
8. I have had prior involvement with the property that is the subject of the Technical Report. The nature of my prior involvement is acting as QP on report titled "NI 43-101 Technical Report Feasibility Study Revenue–Virginius Mine Ouray, Colorado" with a report date of July 30, 2018 and an effective date of June 15, 2018.
9. I have read NI 43-101 and Form 43-101F1 and the sections of the Technical Report I am responsible for have been prepared in compliance with that instrument and form.
10. As of the aforementioned Effective Date, to the best of my knowledge, information and belief, the sections of the Technical Report I am responsible for contains all scientific and technical information that is required to be disclosed to make the Technical Report not misleading.

Dated this 11th Day of March, 2022.

"Signed"

"Sealed"

Jeff Osborn, BEng Mining, MMSAQP [01458QP]
Principal Consultant (Mining Engineer)

U.S. Offices:

Anchorage	907.677.3520
Clovis	559.452.0182
Denver	303.985.1333
Elko	775.753.4151
Fort Collins	970.407.8302
Reno	775.828.6800
Tucson	520.544.3688

Canadian Offices:

Saskatoon	306.955.4778
Sudbury	705.682.3270
Toronto	416.601.1445
Vancouver	604.681.4196
Yellowknife	867.873.8670

Group Offices:

Africa
Asia
Australia
Europe
North America
South America

CERTIFICATE OF QUALIFIED PERSON

I, Benjamin Parsons, MSc, MAusIMM (CP) do hereby certify that:

1. I am a Principal Consultant (Resource Geology) of SRK Consulting (U.S.), Inc., 1125 Seventeenth Street, Suite 600, Denver, CO, USA, 80202.
2. This certificate applies to the technical report titled “NI 43-101 Technical Report, Feasibility Study, Revenue–Virginius Mine, Ouray, Colorado” with an Effective Date of December 31, 2021 (the “Technical Report”).
3. I graduated with a degree in Exploration Geology from Cardiff University, UK in 1999. In addition, I have obtained a Masters degree (MSc) in Mineral Resources from Cardiff University, UK in 2000 and have worked as a geologist for a total of 20 years since my graduation from university. I am a member of the Australian Institution of Materials Mining and Metallurgy (Membership Number 222568) and I am a Chartered Professional.
4. I have read the definition of “qualified person” set out in National Instrument 43-101 (NI 43-101) and certify that by reason of my education, affiliation with a professional association (as defined in NI 43-101) and past relevant work experience, I fulfill the requirements to be a “qualified person” for the purposes of NI 43-101.
5. I visited the Revenue Mine property on August 24, 2015, October 19, 2015, June 20 to 22, 2016, February 21 to 24, 2017.
6. I am responsible for Geology Sections 4 through 12, 14, 23 and portions of sections 1, 25 and 26.
7. I am independent of the issuer applying all of the tests in section 1.5 of NI 43-101.
8. I have had prior involvement with the property that is the subject of the Technical Report. The nature of my prior involvement is acting as QP for report titled “NI 43-101 Technical Report Feasibility Study Revenue–Virginius Mine Ouray, Colorado” dated July 30, 2018 with an effective date of June 15, 2018.
9. I have read NI 43-101 and Form 43-101F1 and the sections of the Technical Report I am responsible for have been prepared in compliance with that instrument and form.
10. As of the aforementioned Effective Date, to the best of my knowledge, information and belief, the sections of the Technical Report I am responsible for contains all scientific and technical information that is required to be disclosed to make the Technical Report not misleading.

Dated this 11th Day of March, 2022.

“Signed”

“Sealed”

Benjamin Parsons, MSc, MAusIMM
Principal Consultant (Resource Geology)

U.S. Offices:

Anchorage	907.677.3520
Clovis	559.452.0182
Denver	303.985.1333
Elko	775.753.4151
Fort Collins	970.407.8302
Reno	775.828.6800
Tucson	520.544.3688

Canadian Offices:

Saskatoon	306.955.4778
Sudbury	705.682.3270
Toronto	416.601.1445
Vancouver	604.681.4196
Yellowknife	867.873.8670

Group Offices:

Africa
Asia
Australia
Europe
North America
South America

CERTIFICATE OF QUALIFIED PERSON

I, Brian Prosser, PE do hereby certify that:

1. I am a Principal Consultant of SRK Consulting (U.S.), Inc., 1125 Seventeenth Street, Suite 600, Denver, CO, USA, 80202.
2. This certificate applies to the technical report titled “NI 43-101 Technical Report, Feasibility Study, Revenue–Virginius Mine, Ouray, Colorado” with an Effective Date of December 31, 2021 (the “Technical Report”).
3. I graduated with a degree in Mining Engineering from Virginia Polytechnic Institute and State University in 1994. I am a licensed engineer in the states of Virginia, West Virginia, Kentucky, and Nevada. I am a Registered Member of the Society for Mining, Metallurgy, and Exploration and a member of the Mine Ventilation Society of South Africa. I have worked as a mining engineer for a total of 27 years since my graduation from university. My relevant experience includes the development of ventilation systems, network modeling, system troubleshooting, and design evaluation.
4. I have read the definition of “qualified person” set out in National Instrument 43-101 (NI 43-101) and certify that by reason of my education, affiliation with a professional association (as defined in NI 43-101) and past relevant work experience, I fulfill the requirements to be a “qualified person” for the purposes of NI 43-101.
5. I visited the Revenue Mine property on September 30 to October 1, 2015.
6. I am responsible for Mine Ventilation Section 16.7 and portions of Sections 1, 25 and 26.
7. I am independent of the issuer applying all of the tests in section 1.5 of NI 43-101.
8. I have had prior involvement with the property that is the subject of the Technical Report. The nature of my prior involvement is acting as QP for report titled “NI 43-101 Technical Report Feasibility Study Revenue–Virginius Mine Ouray, Colorado” dated July 30, 2018 with an effective date of June 15, 2018.
9. I have read NI 43-101 and Form 43-101F1 and the sections of the Technical Report I am responsible for have been prepared in compliance with that instrument and form.
10. As of the aforementioned Effective Date, to the best of my knowledge, information and belief, the sections of the Technical Report I am responsible for contains all scientific and technical information that is required to be disclosed to make the Technical Report not misleading.

Dated this 11th Day of March, 2022.

“Signed”

Brian Prosser

“Sealed”

U.S. Offices:

Anchorage	907.677.3520
Clovis	559.452.0182
Denver	303.985.1333
Elko	775.753.4151
Fort Collins	970.407.8302
Reno	775.828.6800
Tucson	520.544.3688

Canadian Offices:

Saskatoon	306.955.4778
Sudbury	705.682.3270
Toronto	416.601.1445
Vancouver	604.681.4196
Yellowknife	867.873.8670

Group Offices:

Africa
Asia
Australia
Europe
North America
South America

CERTIFICATE OF QUALIFIED PERSON

I, John Tinucci, PhD, PE, ISRM, do hereby certify that:

1. I am Principal Consultant (Geotechnical Engineer) of SRK Consulting (U.S.), Inc., 1125 Seventeenth Street, Suite 600, Denver, CO, USA, 80202.
2. This certificate applies to the technical report titled “NI 43-101 Technical Report, Feasibility Study, Revenue–Virginius Mine, Ouray, Colorado” with an Effective Date of December 31, 2021 (the “Technical Report”).
3. I graduated with a degree in B.S. in Civil Engineering from Colorado State University, in 1980. In addition, I have obtained a M.S. in Geotechnical Engineering from University of California, Berkeley, in 1983 and I have obtained a Ph.D. in Geotechnical Engineering, Rock Mechanics from the University of California, Berkeley in 1985. I am member of the American Rock Mechanics Association, a member of the International Society of Rock Mechanics, and a Professional Member of the Society for Mining, Metallurgy & Exploration. I have worked as a Mining and Geotechnical Engineer for a total of 37 years since my graduation from university. My relevant experience includes 34 years of professional experience. I have 20 years managerial experience leading project teams, managing P&L operations for 120 staff, and directed own company of 8 staff for 8 years. I have technical experience in mine design, prefeasibility studies, feasibility studies, geomechanical assessments, rock mass characterization, project management, numerical analyses, underground mine stability, subsidence, tunneling, ground support, slope design and stabilization, excavation remediation, induced seismicity and dynamic ground motion. My industry commodities experience includes salt, potash, coal, platinum/palladium, iron, molybdenum, gold, silver, zinc, diamonds, and copper. My mine design experience includes open pit, room and pillar, (single and multi-level), conventional drill-and-blast and mechanized cutting, longwall, steep narrow vein, cut and fill, block caving, sublevel caving and cut and fill longhole stoping and paste backfilling.
4. I have read the definition of “qualified person” set out in National Instrument 43-101 (NI 43-101) and certify that by reason of my education, affiliation with a professional association (as defined in NI 43-101) and past relevant work experience, I fulfill the requirements to be a “qualified person” for the purposes of NI 43-101.
5. I visited the Revenue Mine property on May 16, 2014, August 24, 2015, and December 15, 2021.
6. I am responsible for Geotechnical Sections 16.2, 18.3 and portions of sections 1, 25 and 26.
7. I am independent of the issuer applying all of the tests in section 1.5 of NI 43-101.
8. I have had prior involvement with the property that is the subject of the Technical Report. The nature of my prior involvement is acting as QP for report titled “NI 43-101 Technical Report Feasibility Study Revenue–Virginius Mine Ouray, Colorado” dated July 30, 2018 with an effective date of June 15, 2018, and providing ground support recommendations for the rehab of the mine workings.
9. I have read NI 43-101 and Form 43-101F1 and the sections of the Technical Report I am responsible for have been prepared in compliance with that instrument and form.
10. As of the aforementioned Effective Date, to the best of my knowledge, information and belief, the sections of the Technical Report I am responsible for contains all scientific and technical information that is required to be disclosed to make the Technical Report not misleading.

U.S. Offices:

Anchorage	907.677.3520
Clovis	559.452.0182
Denver	303.985.1333
Elko	775.753.4151
Fort Collins	970.407.8302
Reno	775.828.6800
Tucson	520.544.3688

Canadian Offices:

Saskatoon	306.955.4778
Sudbury	705.682.3270
Toronto	416.601.1445
Vancouver	604.681.4196
Yellowknife	867.873.8670

Group Offices:

Africa
Asia
Australia
Europe
North America
South America

Dated this 11th Day of March, 2022.

"Signed"

"Sealed"

John Tinucci, PhD, PE, ISRM